

AT MICROFICHE REFERENCE LIBRARY

A project of Volunteers in Asia

Pigs and Foultry in the South Pacific

by: Ian Watt and Frank Michell

Published by:

Sorrett Publishing Pty. Limited
P.O. Box 94, Malvern
Victoria 3144
Australia

Paper copies are A\$ 2.95 (Australian dollars).

Available from:

Sorrett Publishing Pty. Limited
P.O. Box 94, Malvern
Victoria 3144
Australia

Reproduced by permission of Sorrett Publishing
Pty. Limited.

Reproduction of this microfiche document in any
form is subject to the same restrictions as those
of the original document.

Pigs and Poultry in the South Pacific

**Ian Watt
and
Frank Michell**



Pigs and Poultry in the South Pacific

Ian Watt and Frank Michell



Sorrett Publishing

This book is copyright
and reproduction of the
whole or part without the
publisher's written permission
is prohibited

© Ian Watt and Frank Michell 1975

First published 1975

Reprinted with minor corrections 1975

Sorrett Publishing Pty Limited

P.O. Box 94, Malvern,

Victoria 3144, Australia

Computer Typeset in Australia by Colcomp Pty. Ltd.

Printed by Toppan Printing Co (Singapore)

ISBN 0 909752 20 6

Foreword

The world food situation, the world food crisis, malnutrition, hunger and starvation are all featured frequently in the news media today; the problems are not new, but they are becoming more acute. Governments and multi-national bodies have been aware of this for decades, but increasingly so since the end of World War II — UNICEF with its concern for mothers and children, FAO with its endeavours to increase agricultural production, individual governments working to increase output, research institutes working on means to boost production, and various other techniques for providing food for the hungry have all contributed a great deal, but despite all these efforts the situation is worsening daily.

One reason for the rather disappointing results of government efforts and aid programmes has been due to the false concept that advanced technology found to be successful in developed countries could be automatically applied to the subsistence farmer environment in developing countries.

In the developing countries which are the main areas of food shortage, approximately eighty percent of the population are subsistence farmers; thus, to develop methods which will help them increase their production must make the greatest impact on increasing overall food production. The problem does not lie in a lack of knowledge of techniques for increasing production, but rather of getting this knowledge to the farmer in a manner he can understand and use, and also in providing the necessary incentives such as accessible markets.

This book, which is projected mainly for an area of age-old traditional agricultural production is the result of many years work in adapting modern knowledge and techniques to such an environment in a form which has been demonstrated to be effective. Problems identified in the field have been submitted to a research unit and the answers supplied by research have then been tested out in the field for acceptance and adoption.

This book sets out in simple language the information required by extension workers and others responsible for helping the farmer. It

deals with all levels, from simple improvisation in a village through to semi-intensive and intensive type production. It is not meant as a textbook for developed countries, but workers from these countries intending to help less-developed nations should read this book carefully. The authors are to be congratulated for putting this material together to assist in training others to increase both pig and poultry production. Helping people to help themselves is surely the answer to continued increased food production, and this book is one more step in this direction.

K.V.L. KESTEVEN

About the Authors

Ian Watt is the Pig Husbandry Adviser for the Papua New Guinea Department of Agriculture, Stock and Fisheries. He is stationed at the Tropical Pig Breeding and Research Centre, Goroka, in the Eastern Highlands District of Papua New Guinea. He has held this position since 1970 and was Officer-in-Charge of a livestock training school before taking up his appointment.

Frank Michell is the Poultry Husbandry Adviser for the Department of Agriculture, Stock and Fisheries. He works from the Poultry Research Centre at Labu near Lae in the Morobe District of Papua New Guinea. He took up his position in 1971 and was a Rural Development Officer in the East Sepik District before that.

As husbandry advisers they are responsible for dissemination of technical information to their respective industries which means that they are closely involved in industry development. Their duties involve extensive travel throughout Papua New Guinea which has led to both men having broad and extensive experience in pigs and poultry under Papua New Guinea conditions.

They have written this book in the belief that there is a need for a book covering husbandry of pigs and poultry in the tropics.

While the book relates primarily to the Papua New Guinea situation much of its contents can be applied to other countries in similar situations.

Contents

Pig Section

1 Management Systems	7
2 Nutrition of the Pig	12
3 Housing	21
4 Breeds	38
5 Sow, Boar and Grower Management	45
6 Management Practices	51
7 Pig Diseases	60

Poultry Section

8 Poultry Production	65
9 Semi-Commercial Poultry Keeping	66
10 Commercial Poultry Raising — Meat Production	69
11 Looking After Small Chickens	73
12 Feeding Young Chickens	77
13 Management and Feeding of Laying Hens	79
14 Timing of Replacement Stock	83
15 Management of Deep Litter	84
16 Ducks	86
17 Some Diseases of the South Pacific	87

Glossary	90
Appendix	91

Acknowledgements

The authors would like to acknowledge the assistance and encouragement given to them in the compilation of this book, particularly Dr. K. Kesteven and Dr. D. Purdy. Others we would like to thank are Douglas Franklin, Don Murray, Ross Weber, Ivor Lopes and Peter Penson.

It would be fair to say that without the kind help of these men the format of the book would not have been as acceptable as it is.

We also wish to recognise the support given to us by the Australian Freedom From Hunger Campaign without which publication may not have been possible.

To those other people who we have not mentioned but who contributed to the final product may we offer our sincere thanks.

We acknowledge the assistance given by the Papua New Guinea Department of Agriculture, Stock and Fisheries which is our employer. This book would not have been possible had we not had access to research results and the experience of many of its officers. It would be unfair to single out any particular persons, but we do wish to record our indebtedness to the Department and its officers.

I.R.W.
F.C.M.

Plates 1–5, 12–16, 19–22, 25 and 26 were supplied by the Papua New Guinea Department of Information and Extension Services.

Plates 17, 18 and 23a were supplied by the *Chronicle* newspaper, Adelaide.

1 Management Systems

In pig production there are several systems under which pigs can be farmed. These systems are: extensive, semi-intensive and intensive.

Each system has its place in the industry. Which system is used by a farmer depends on many things, from the amount of money he has to invest to the amount of land he has available and his managerial ability. Some farmers can intensively raise pigs, but others need a simpler form of farming and so use the semi-intensive system. To give an idea of what each system involves, they will be discussed separately.

1 Extensive

This is the system of farming pigs most commonly found in Papua New Guinea. It is the traditional way of running pigs used by villagers for many hundreds of years. Not only is it popular in Papua New Guinea, there are many farmers throughout the world who also farm this way.

Its biggest advantage is that it involves very little capital either in the form of money or materials. The pigs are allowed to run free and to find food for themselves, but can be restricted by fencing or can be leg-tied. Under this system growth rate is usually low because of poor, and often restricted, nutrition. Unless the pig is fed some form of ration it must find its daily needs by foraging. Protein is usually found in the form of worms and small insect life whilst energy is found in roots, tubers and grass.

Not all breeds of pigs are suited to extensive farming. The Large White, for example, has been bred to perform best under intensive and relatively advanced management systems. In other words, it requires good housing, good nutrition and good management. Extensive farming does not provide these factors and the Large White cannot readily adapt to the harsher environment and lower level nutrition of the extensive system. On the other hand, the native pig is ideally suited. It can withstand the weather and harsh environment and more than adequately copes with the poor standard of nutrition. The native pig has an advantage over British type animals in that it has undergone natural selection for its environment, whereas the British type pigs have been bred and selected for a much more advanced system of farming.

For the villager who keeps his pigs for prestige, and because of traditional values, the extensive system is ideal. For the man wanting to keep pigs as a commercial money-making business, it is not economic.

2 Semi-intensive

This is the next step along the way to a fully intensive system. Semi-intensive farming of pigs has the best features of both the other management systems. It includes the advantages of running pigs outside with the benefits gained by housing and feeding them.

Probably the most common form of semi-intensive pig farming is the keeping of the breeding herd outside in runs or small paddocks with the growing of the piglets inside houses in pens.

The outside runs can be planted down to pastures or some form of crop (e.g. sweet potato) and grazed, or can be just an area of natural grass fenced off. Each run usually has a simple shelter in it which may or may not be movable. Runs must be strongly fenced and must be rested occasionally to prevent a build-up of internal parasite eggs. It is therefore necessary that there must be several runs so that one can be rested every three months or so.

The pigs are fed a ration which supplements the grazing material. If pastures are being grazed the supplement can be a complete ration of crushed grain and concentrate. If the pigs are fed a staple food such as sweet potato, the supplement need only be a protein-rich food such as concentrate or soybeans. The important point is that, whatever the pigs may be grazing, some additional protein is necessary. Without it, growth rates will be low, pigs will be malnourished, and profits will be very small.

The big advantages in a semi-intensive system is the level of management required and the savings in labour. Producers who have traditional or other outside duties quite often neglect their pigs under intensive management conditions. Intensive pig production requires considerable labour inputs for the harvesting and cooking of staple foods, and the hand-feeding of the pigs. In a family business this heavy labour commitment has a limiting effect on the size and profitability of the business. Grazing of pigs under a semi-intensive system effectively overcomes these two problems because day-to-day labour is very little thus releasing the owner for other duties or allowing him to keep more pigs for his available labour. The main limiting factor with the system is the availability of land. This limits its potential in some areas where population density is high.

An example of a semi-intensive system is as follows:

Area required: 0.5 hectare of fairly flat, well drained land

Number of Pigs: Ten fatteners per annum

Fencing Materials: 93 posts or star pickets,
8 rolls (50 metres) pig wire
4 rolls (100 metres) barb wire
Housing: Portable bush materials shelter
Feed: 8 x 50Kgm bags of pig concentrate;
fed at the rate of 230 gms concentrate per head per day
Other Materials: Water and feed containers.

Method of Development

The land is ploughed or hand worked, and fenced using one post every three metres. The pig wire is attached to the inside of the posts with the larger squares at the top. One barb wire is run 20 cm from the ground to prevent the pigs from up-rooting and damaging the fence. The land is marked out into 0.05 hectare plots (50 metres x 10 metres) using markers and the sweet potato is planted at the following intervals.

Plot two	— 5 weeks after plot one
Plot three	— 4 weeks after plot two
Plot four	— 4 weeks after plot three
Plot five	— 3 weeks after plot four
Plot six	— 2 weeks after plot five
Plot seven	— 5 weeks after plot six
Plot eight	— 4 weeks after plot seven
Plot nine	— 4 weeks after plot eight
Plot ten	— 3 weeks after plot nine.

It must be remembered that the larger a pig grows the less time it spends in a plot because of its increased consumption of sweet potato. Similarly, the younger and smaller a pig is, the more time is spent in a plot, thus necessitating different planting intervals between plots. If the pigs are to be sold before they reach the tenth plot, an allowance must be made in the planting program for the requirements of the young replacement stock.

Each plot is maintained separately with careful weeding. The boundary fence will keep the native pigs out so pig damage will be as little as possible.

When the first plot is mature five weaner pigs are placed inside with adequate shelter and water. A portable fence of the same type as the boundary fence is built to stop the pigs from grazing the second plot.

Five separate containers are needed to feed the pigs their 230gms protein concentrate each per day as this will stop fighting for food and will prevent one or two pigs growing faster than the rest.

Five weaner pigs will take approximately six weeks to graze the first plot. When the pigs appear to have eaten nearly all the tubers, they are moved into the second plot. The pigs should not be left too long in the

first plot as they will lose weight and condition very quickly once the supply of sweet potato ceases.

Before they are shifted into the second plot, a second dividing fence is built to prevent them grazing the third plot. The pigs are now enclosed by two dividing fencelines and the boundary fence. The portable house, water and feeding containers are also shifted into the second plot.

Because the pigs have been rooting around searching for the tubers, the soil will be loose and easy to dig. The mounds or ridges are reformed by spade and replanted with runners from the second plot. Any tubers found during replanting can be fed to the pigs. It should not take more than half a day to a full day to move the pigs, the equipment and to replant the plot.

When the pigs are moved into the third plot approximately 4-5 weeks later, the fenceline dividing plots one and two is removed and placed in position to divide plots three and four. In this way, fencing work can be greatly reduced by having only two sub-divisional fences instead of nine permanent fences doing the same job.

This example is suitable for the farmer who is growing his pigs for four and one half months which means that he will sell his pigs when they have finished grazing plot 6. As soon as he has sold his pigs he will restock plot seven with five weaner pigs.

The example is only good for areas where sweet potato matures at eight months. It takes 34 weeks for the pigs to graze through ten plots which means that they will return to plot one eight months after it has been replanted. In areas where sweet potato matures earlier a different planting timetable must be worked out which may mean that the plots lay unplanted for several months while the pigs graze the remaining nine plots.

If the sweet potato takes four months to mature then plot one would not be replanted until plot six has been grazed, plot two would not be replanted until plot seven has been grazed and so on.

It would probably take a farmer one or two crops to work out his planting timetable but once he has done so the system should work easily.

Depending on the market the pig is being produced for, the pigs are taken out at the desired weight and the next plot restocked with five weaners.

Under this system the pigs should average about 300 grams a day liveweight gain over a six month period. Assuming the weaners weigh about 14 kgms when they are placed in the first plot, they should weigh about 68 kgms six months after they started grazing.

The big advantage of this system is that the pigs do not rely upon the owner for all their food needs as they are harvesting their own energy foods. They only rely on the owner for the daily feeding of protein-rich foods and water. With only five pigs to feed and check each day the owner would not spend much more than 15 minutes a day with his pigs apart from the days he is shifting stock and replanting. The system could be successfully used by people with outside work such as council workers or tradestore owners.

Internal parasites are not a problem as the pigs spend no more than six weeks in any one plot and do not return to that plot for another eight months. This is usually enough time for most internal parasite eggs to die. Swampy soil should be avoided as this is an excellent home for kidney worms. Similarly, land where pigs have been traditionally grazed should also be avoided as it too is likely to be infested with parasites.

3 Intensive

The intensive way of producing pigs involves keeping the pigs in a restricted area and providing all feed and water. Most commercial piggeries established in Papua New Guinea are based on this method of production.

While the design of the house is not very important from the general comfort of the pig, the standard of management needed is quite high — much higher than for either of the other two systems. The pig depends entirely upon the farmer for its food and water. If the farmer does not feed it, the pig starves and will finally die. If the pig is not fed the correct food it will not grow quickly and may also fail to breed through malnutrition.

Where the level of management is good, the intensive way of farming pigs is very profitable. If, however, the level of management is poor, the piggery will be a failure. There is no room for slackness or laziness in this type of piggery.

The breeds of pig most suited to intensive farming are the British breeds and their cross-breeds. These pigs can achieve rapid and efficient growth rate and are very good breeders. But it must be remembered that they cannot stand up to low levels of management like the bush native pig can, so it is important that farmers realise the benefits which can result from good management as well as those resulting from poor management.

There are circumstances and situations where each system of management has its place. It is not enough for everyone to have either an intensive or semi-intensive piggery. Some situations will warrant one or the other and each has a definite place in the commercial raising of pigs.

2 Nutrition of the Pig

The level of success a pig farmer enjoys will depend upon his ability to feed his pigs enough and to feed them correctly. There is no other single factor affecting a farmer's profit as important as nutrition. If an animal is not fed the correct foods at the required levels it will not grow at an economic rate. As the goal of every commercial pig farmer is to make a profit, it is essential that he feed his pigs correctly.

Foodstuffs can be divided into three general classes — those rich in protein, those rich in carbohydrate, and those in between (which are usually grains).

Before classifying the foods commonly used to feed pigs in Papua New Guinea, it is important to understand the needs of the pig for protein, carbohydrate, minerals and vitamins.

Protein

Protein is essential for growth and development, reproduction and for the maintenance of body tissue. It is essential for life. In commercial pig production, the farmer is vitally concerned with growth rate of his market pigs, but at the same time he must be very careful to maintain a healthy herd. Because a piggery centres around the growing of pigs, it follows that whatever makes the pigs grow is of major importance. Protein is necessary for growth so it is essential that the pigs are fed an adequate level of protein in their diet.

The period of maximum growth in pigs is during the first six months of life. It is during this time that the pig needs higher levels of protein than during adult life. The following classes of growing pigs illustrate the varying levels of protein required:

<i>Weight Range</i>	<i>Class</i>	<i>Protein Required</i>
3 – 30	Sucker	22%
30 – 60	Weaner	18%
60 – 140	Porker	16%
140 – 180	Baconer	14%

Table 1. Protein requirements of growing pigs

It can be seen from the above Table that during the period of most

rapid growth the protein requirement is highest and that this requirement drops as the pig matures.

Not only is the quantity of protein in the diet important — quality must be good also.

Protein is made up of various amino acids which, when joined together, form a protein molecule. Depending upon how these amino acids join, so the quality of the protein is decided upon. Plant proteins are richer in some amino acids whereas animal proteins are richer in others. There are twenty-two amino acids of which eleven are essential for growth.

The best form of protein is that which provides all of the amino acids required by the pig, but few, if any can do so. It is usually necessary therefore for several different protein foods to be mixed together to provide the best protein quality.

Carbohydrates

Carbohydrates supply energy which is used by the animal for warmth, for work and for proper working of the body. Like protein, carbohydrate is necessary for life and is therefore important.

Carbohydrates provide much of the energy used by pigs. They include sugars, starches, gums and many other substances all of which consist of atoms of carbon, hydrogen and oxygen — hence the abbreviation, CHO, which is commonly used for carbohydrates.

It is not possible to discuss carbohydrates without including energy as the carbohydrates form the bulk of energy used by the pig. Energy is measured in calories, 1,000 of which make up a Kcal. Again different classes of pigs require different levels of energy.

<i>Weight</i>	<i>Class</i>	<i>Kcals Energy Required</i>
5 kgm	Sucker	1,280
12 kgm	Sucker	3,200
25 kgm	Weaner	4,800
45 kgm	Porker	8,000
70 kgm	Baconer	9,200
230 kgm	Pregnant Sow	10,000
210 kgm	Lactating Sow	18,800
180 kgm	Adult Boar	9,500

Table 2. Energy requirements of various classes of pigs

It can be seen from the Table that, as the pig increases in size, its need of energy also increases with a lactating sow needing more energy than any other class of pig. Because a larger pig needs increased quantities of energy does not mean that the ration must have proportionately more energy for the same unit of weight. The increased need is met by an increased appetite and so the amount eaten is increased.

For example, a 25kgm pig may consume about 1.5kgm of a grain based ration, while a sow suckling eight piglets can consume up to 9 kgm per day.

Minerals

It is generally agreed that animals require 13 different minerals, with the major ones being calcium, phosphorus, sodium, chlorine and iron.

A shortage of calcium and phosphorus will result in reduced appetite, slow growth, lameness and stiffness, weak bones, reduced reproduction and may cause dead or weak piglets at birth. About 70 per cent of the mineral matter in the body of a pig is calcium and phosphorus. Because a shortage can be so harmful to not only the health of the herd, but also the profitability of the piggery, they are rated as the most important of the minerals.

Sodium and chlorine form salt and are supplied in the pig's ration as such. A shortage of salt causes reduced appetite, slow growth and poor skin.

Iron is essential for haemoglobin formation in the blood so the most common symptom of iron shortage is anaemia. Iron shortage also affects appetite, growth and reproduction performance. Young pigs — up to two to three weeks of age — are easily affected by an iron shortage.

It is apparent, therefore, that minerals form an important part of animal nutrition and must be supplied in adequate quantities if herd health and performance is to be maintained at a high level.

Vitamins

Vitamins are necessary for the function of body processes. Vitamins are necessary for certain processes related to effective and efficient use of foodstuffs by the body. They are needed in very small amounts, but are still important in a balanced ration.

Vitamin A is the most important of the vitamins and it is used for the normal working of the eye and of the respiratory, digestive, reproductive and urinary systems. A shortage results in slow growth, poor appetite, staggering walk, convulsions and paralysis. While a shortage causes serious symptoms, adequate amounts of yellow corn or green grass will provide enough vitamin A (or carotene) to overcome any problems.

Vitamin D is needed for efficient and rapid growth, for good health in new-born pigs, and it is also believed to be needed for bone growth. A shortage will lead to stiffness, stilted walk, broken bones, rear-end paralysis and weak bones. Letting the animal out into sunlight or giving it a diet containing fish oils or sun-cured hay, will overcome any shortages.

Vitamin B1 or thiamine is needed for the use of carbohydrates by the body. A shortage results in slow growth, decreased appetite, vomiting, below normal temperature and general weakness of the body.

Niacin is another vitamin needed by the body to use carbohydrates.

There are many other vitamins needed for body functions and good health, but the four mentioned above show the importance of adequate vitamin levels in the ration.

It can be seen that there is more to feeding pigs than just feeding scraps. The efficient and careful farmer will be aware of the nutritional needs of his stock and will provide rations adequate to meet the animal's needs.

<i>Protein Foods</i>	<i>Energy Foods</i>	<i>Others</i>
Fishmeal	Sweet Potato	Sorghum
Meatmeal	Taro	Rice
Soybeans	Cassava	Corn
Peanuts	Yam	
Fish	Banana	
Protein Concentrate	Paw Paw	

Table 3. Classification of tropical foodstuffs

There are two striking things about the above table. One is that all of the energy foods which are commonly found in tropical countries are staple foods. In other words, they are foods commonly grown for human use. The second point is that the protein foods are grown and produced in small quantities when compared to the energy foods and are more expensive to buy per unit of weight.

It is therefore fair to say that people eat more energy foods than they do protein foods. Pigs are the same — they eat for energy, not protein. This is understandable as animals — and humans — require more energy, under normal circumstances, than protein.

Feeding Pigs

Unfortunately for many countries, protein foods are not produced in large amounts. Generally speaking, all the protein food produced in the world can be eaten by the human population rather than feeding it to animals. For this reason, high protein foods of mainly animal origin are imported from Australia and other countries. With the establishment of a small meatmeal processing plant and a tuna offal processing plant, Papua New Guinea will be less dependent on imported protein feeds than in the past, but it will be many years before these imports will be significantly reduced.

While some fishmeal and soybean meal is fed to pigs, high quality protein concentrate forms the basis for most rations. Protein concentrate consists of several high protein foods such as meatmeal,

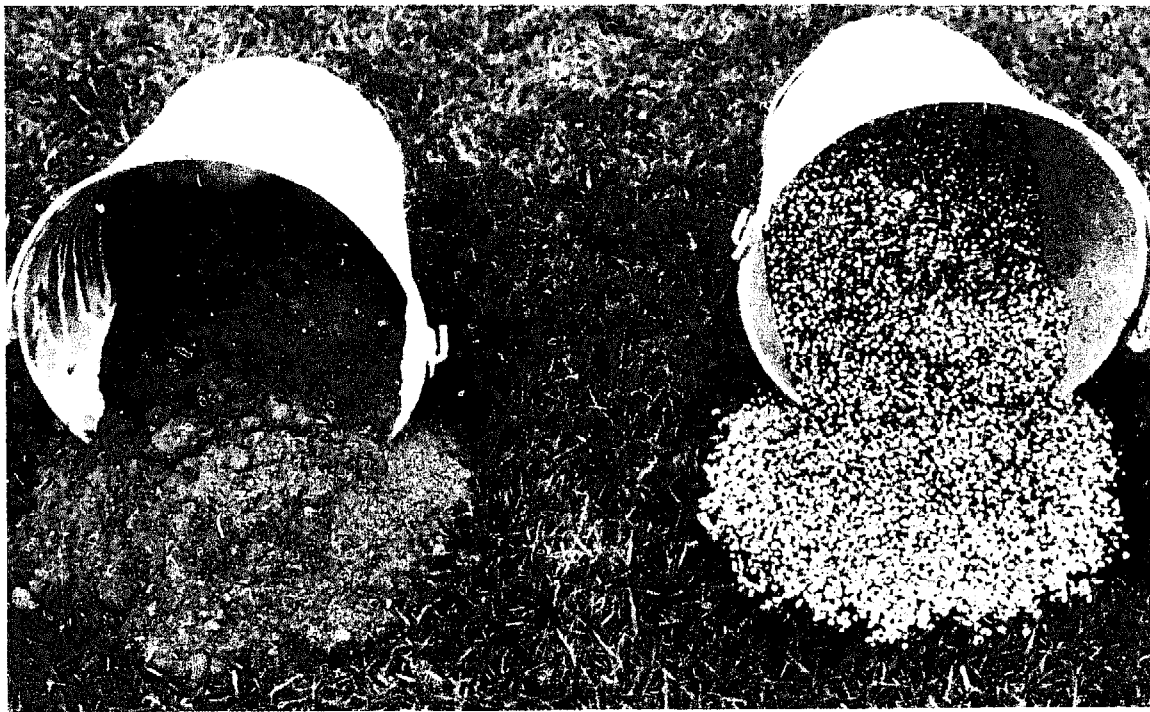

Plate 1. Two types of protein rich foods. On the left is protein concentrate imported from Australia and on the right whole soybeans.

fishmeal, soybean meal, sunflower meal, feather meal, and cottonseed meal with vitamins and minerals added. It is usually sold as a 50 to 57 per cent protein meal, but world shortages of protein caused a drop in protein — and an increase in price — to 40 to 46 per cent. Protein concentrate was originally meant for mixing with grains, but experience in Papua New Guinea has shown good results when fed with staple foods.

The Lehmann System

Extensive research has been conducted into the feeding of protein concentrate, and other protein foods, at the Department of Agriculture, Stock and Fisheries Tropical Pig Breeding and Research Centre, Goroka, Papua New Guinea. The staff at the Centre have changed the German Lehmann system of feeding potatoes to pigs to a system which is practical, and profitable.

The system requires that 0.5 kgm of 50 per cent protein concentrate be fed to every pig regardless of size (over weaning age) daily with sweet potato or other staple. For growing pigs the level of sweet potato fed is important as a shortage will cause a decrease in growth rate, so the potatoes are fed *ad lib* which means that they are fed as much as they can eat each day. As the pigs reach maturity it is sometimes desirable — as with working boars — that they do not become too large and too fat. It then becomes necessary to restrict the amount of potatoes fed. By feeding 6 - 7 kgms of sweet potatoes daily to these pigs, growth will be very slow and health will not suffer. It is worth remembering that it is difficult for adult pigs to lose excess fat.



Plate 2. A crop of soybeans nearly ready for harvest.

1 Lactating Sows

Lactating sows, require much more of both the protein and energy foods than any other class of pig. The reason for this is very simple — she is feeding her piglets which are growing at a very fast rate. She needs extra protein and energy over and above her maintenance level for milk production. It is of vital importance to the profitability and the general health of both the sow and litter that her feed should not be restricted in any way whatsoever. To get adequate levels of both protein and energy the sow should be fed 1kgm of 50 per cent protein concentrate per day and *ad lib* sweet potatoes. As soon as lactation stops, the sow can be returned to the 0.5 kgm level with lesser amounts of sweet potato.

2 Suckling Piglets

Piglets usually start eating solid foods at about two weeks of age. From about seven days onwards they nose through the sow's ration and may start nibbling at it from ten days of age. When this happens it is time to start feeding them separately. As the young piglets need higher levels of protein than the sow (because they are growing so fast) it is necessary to feed them a separate and different ration. It is also necessary to keep the sow away from this special ration as it is too rich (and too expensive) for her. Because of this it is called a "creep" ration as it is in the creep area of the farrowing pen where the sow cannot get at it.

The creep ration is a 20 per cent protein ration consisting of three

parts protein concentrate to five parts cooked sweet potato. The concentrate is mixed with the potato and a little sugar can be sprinkled on top of the mix to attract the piglets to it. Once the piglets have started eating regularly, the sugar can be stopped. Creep feed is fed until the piglets are about eight weeks of age, when they are gradually changed over to the normal Lehmann system. Care must be taken to maintain a high level of hygiene when feeding young piglets as they very easily get stomach upsets.

Food should preferably be cooked twice daily and containers must be thoroughly scrubbed clean daily.

If suckling pigs are fed adequate quantities — *ad lib* feeding is desirable — maximum growth rates will result. Adequately fed piglets could weigh as much as 18 kgms at six weeks of age through correct creep feeding.

3 Growing Pigs

The basic Lehmann system can be used from about eight weeks of age on. Where the market is not too particular about the amount of fat on the meat, it is best to feed sweet potatoes *ad lib*, but where the market does not like too much fat the level of sweet potatoes must be restricted from 40 kgms liveweight on. When changing rations or foodstuffs it is important to make the changeover a slow one. A sudden change in diet could cause stomach upsets and will cause a reduction in rate of bodyweight gain for several days. By gradually introducing the new food into the ration over a four to six day period, these problems can be avoided.

4 Other Foodstuffs

There appears to be no reason why other foodstuffs cannot be used in the system besides concentrate and potatoes. Soybeans and Cassava have been tried at Goroka with quite good results.

When working out the amounts of any particular high protein foods used to replace concentrate it must be remembered that the system works on 0.25 kgms of *pure* protein (0.5 kgms of 50 per cent protein concentrate yields 0.25 kgms of pure protein) being fed to each pig daily. Energy goods are fed *ad lib*.

As fishmeal, meatmeal and soybeans become more readily available they will be used more often for feeding pigs.

Grain Based Rations

In some areas, it is probable that the industry will depend to a greater extent on grain based rations rather than the Lehmann system of feeding.

The feeding of grain based rations is a common method used all over the world and is very efficient. In other countries many farmers grow

their own grain and feed it to their pigs. This method involves the purchase of a milling and mixing plant as well as grain storage facilities, but the cost of the grain (which forms the major part of the ration) is reasonably low. Other farmers purchase their rations from a feed milling company as a complete ration. These people pay more for this service, but they do not have to purchase equipment for mixing their own rations and they are getting a guaranteed product from the miller. This has a major advantage in that more breeding sows can be managed by one man when he does not have to produce and mix his own feed. It also has another considerable advantage in that the risk of ration mixing mistakes is almost non-existent for the simple reason that the miller's livelihood and good name rests on his mixed feed so he is less likely to make a mistake when mixing his feed.

For the farmer mixing his own grain based rations the following formulations are all that is needed:

Creep Feed: (20 per cent protein)	3 parts grain
	1 part concentrate
Grower Ration: (16 per cent protein)	3 parts grain
	1 part concentrate
Adult Ration: (14 per cent protein)	9 parts grain
	1 part concentrate

No additional minerals or vitamins are required.

Again, *ad lib* feeding of pigs to 40 kgms liveweight gives fast growth and efficient gain, but restricted feeding after that stage is necessary where excess fat is not wanted.

Generally speaking, porkers can be restricted to 1.5 kgms per day with baconers at 2 kgms per day. Adult stock should not get more than 2.5 kgms per day except lactating sows which should be fed 2.5 kgms plus 0.5 kgms extra for each piglet they are suckling. This will ensure that they are getting an adequate level of nutrition during lactation.

By-Products as Pig Feeds

The two most notable byproducts which could be fed to pigs and which are readily available in some countries are rice bran and copra meal. Rice bran is produced as a by-product from the rice processing operation. As more mills come into operation, so the supply of bran will increase. Rice bran is reasonably high in fibre, but can form part of the ration if desired. For adult pigs — who can use fibre better than can younger pigs — it could be fed at any level up to 40 per cent of the ration. That is, four tenths of the total food fed to an adult pig could be rice bran. For younger pigs, a level closer to 25 per cent would do no harm.

Copra meal is a by-product from the oil extraction process in the

copra industry. It can be fed at levels up to 30 per cent for growing pigs and 40 per cent for adult pigs.

The inclusion of by-products in a ration will, to a large extent, depend upon the availability and the cost.

Economics of Formulating Rations

Which foodstuffs are fed to pigs depend mainly on cost and availability which are closely related. There is no point in feeding an expensive energy food if there is a cheaper one available which will give similar results. Similarly, the cost of producing a kilogram of meat may be higher than need be because too much protein is being fed when it is not required. It is very important for the economic success of the enterprise that the costs of production be kept as low as possible and that the selling price of the finished product — the pig — be as high as possible. A close watch should be kept on those foodstuffs not used in a ration which are locally available as well as those foodstuffs within the ration. When feed costs rise as they did in 1973/74, a change in ration formulation may be necessary. The alert producer notices this trend and acts accordingly thus making a better return from his piggery than his less alert neighbour.

An example of the cost of feed affecting a ration formulation was during the price rise for protein concentrate imported into Papua New Guinea from Australia in 1973/74. In 1972 pig concentrate was a 57 per cent protein feed retailing at Goroka for about \$13 per 125 lb. bag. A serious world-wide shortage of protein resulted in the price reaching \$23 per 110 lb bag of 45 per cent protein concentrate in 1974. This price rise associated with the drop in protein content caused the Department of Agriculture, Stock and Fisheries to alter its Lehmann system recommendation to 0.25 kgm of protein concentrate per pig per day. This resulted in slower growth rates, but meant a slightly increased return per pig marketed and better use of the small protein concentrate supplies available.

One way the farmer can compare the prices of different foods that are available is by calculating the Unit Price of Protein. For example, if protein concentrate costs \$23 per 110 lb. bag containing 45 per cent protein, then the cost of 1 per cent or 1 unit of protein is $\frac{\$23}{45} = 51.1$ cents.

Another protein food such as meat and bone meal may cost \$20 per bag of 110 lbs. with a protein content of 35 per cent. The Unit Price of protein in this case would be $\frac{\$20}{35} = 57.1$ cents.

Thus the more expensive protein concentrate at \$23 per bag is the cheaper food in terms of its *protein content*, which after all is what the farmer is most concerned with.

The Unit Price of carbohydrate and even complete rations can be calculated in the same way.

3 Housing

Selection of a suitable site for the piggery and especially the house is quite important but its importance is often overlooked. There are many factors to be taken into consideration when deciding where to site a piggery. Some of these are:

- availability of water
- nearness of gardens
- nearness to a road
- drainage
- direction of prevailing winds
- aspect

1 Availability of Water

Like all animals pigs require certain quantities of water each day. In high altitude areas a lactating sow needs about twenty two litres per day and this figure would be higher on the coast. Water is difficult to carry and is heavy per unit of bulk so the piggery should be put close to a reliable all-year round supply. There is no point in putting the piggery near a creek if it only runs during the wet season. If a river is reasonably fast flowing an hydraulic ram can be used to pump the water to the house. Another method of getting water to the pigs is to put the house in such a place that a drain can be used to bring the water past it. If it is at all possible some means of getting the water to the house other than carrying it should be used.

2 Nearness of Gardens

Carrying food to feed pigs is not a pleasant job at any time of the year no matter where the piggery is. It is tiring, boring and hard work but it is necessary if the project is to succeed. It does not matter where the house is put, some carrying of food will be necessary but if the gardens are planted around the house not much work in carrying the food will have to be done.

3 Nearness to a Road

There are always some goods which need to be freighted from large cities and towns by road. Such things as feed, piping, stock and many other smaller items are usually freighted by truck to the nearest point where a road is to the piggery. Similarly if the pigs are to be sold through a butcher, abattoir or to someone else outside the immediate



Plate 3. Having water near the pig house is very important. Note the partly built piggery behind the farmer and the agricultural officers.

community, transport will be required to take the pigs away. The closer the piggery is to the road the less work there is to be done when either freight arrives or pigs are to be removed. Another point not to be overlooked is that of advisory work. An advisor will be more likely to visit piggeries which do not involve wasted time in walking. In other words, those piggeries sited near the road are easier to visit and will receive more attention than those sited some distance away.

4 Drainage

No-one wants to work or live near a place which has bad smells and lots of flies. If a piggery is built on a site with poor drainage effluent will collect and lie in low patches causing both bad smells and attracting flies. A piggery needs to be on a well drained site where the effluent can be drained away by drains. A lot of piggeries in Papua New Guinea run the effluent into creeks and rivers because it is an easy and effective means of disposal. Apart from the pollution problems this practice is wasteful in that good garden fertiliser is lost. By diverting the drains into the gardens, the effluent can be used to water and fertilise plants. Pig manure is high in nitrogen and is a rich garden fertiliser.

5 Direction of prevailing wind

The house should not be built facing into a prevailing wind as the wind and rain will blow into the pens and make the pigs uncomfortable. Sometimes there is not much choice as to what direction the house will

face in which case some form of protection against the weather is necessary. Trees can be planted to provide windbreaks and a roof can be built to give as much protection as possible.

6 Aspect

In cooler areas it is a good idea to build the house in such a way that maximum use of direct sunlight is achieved. This means facing the house to the north so it gets as much of the sun as it can. If it faces east then it only gets the morning sun and if it faces the west it will only get the afternoon sun. In the hotter areas however, direct sunlight is not so important and in many cases must be avoided. The easiest way to overcome this problem is to cover the whole house with a high roof.

It can be seen that it is not a simple matter to select a suitable site for a piggery. There are many factors to be taken into consideration some of which will be opposite to others in which case each situation must be considered on its good points. In some cases there is only one possible site for the house but these situations are rare.

Once the site has been selected the next step is to decide upon the type of building needed and its design.

There is probably no other part of pig production which is subject to more personal ideas than pig housing. Every farmer has his own ideas on what the ideal house is and he tries to build to this ideal. The differences in housing to be seen are many and in most cases are satisfactory. The main reason for building a house is to provide some form of shelter from the elements and to provide a better environment for the pig to live in — at least better than it would otherwise have if it were free grazing. Of course there are many different ways of achieving this aim and this is why there is so much variety in both housing design and the materials used.

There are several basic things every house must have. These are the floor, walls and roof. How these are put together to form the house depends upon the owner, the availability of the materials and the location of the house.

The most readily available form of building material in many tropical countries is bush timber. Bush materials are the most common form of building material for traditional housing and are equally satisfactory for pig housing. Other materials available include milled timber, galvanised iron sheeting and piping, wire and cement. There is a wide choice of materials to choose from and there are many ways they can be used together.

There are basically four different types of pig housing which can be built. These are bush materials with either a concrete, deep litter or slatted floor or a "permanent" materials house.



Plate 4 Plastic can be used as an insulation material.

Concrete Floor Building

This type of floor is probably the most popular used in piggeries. It is relatively easy to build, is long lasting and is easily maintained. It does represent however a capital outlay which cannot be of any other value should the owner decide to give up pigs. Once a concrete floor is laid it is there for many years. There are several ways in which a concrete floor can be made but there is only one way which is suitable for pigs. This type of floor is called an insulated floor.

An insulated floor is one which keeps its heat and is neither cold nor damp. If a pig is made to sleep on a cold and damp floor it will develop arthritis in its joints and will develop respiratory problems. In other words, a cold damp floor causes severe health problems for the pig. It is therefore important to avoid providing conditions which can lead to health problems. A conventional concrete floor of sand, cement and aggregate laid on bare earth is not good enough for pigs and is also very expensive to build. An insulated floor includes a barrier which prevents soil moisture from moving up into the floor and also prevents warmth from being lost to the soil.

In this type of floor the plastic sheeting acts as the barrier preventing soil moisture from dampening the floor while at the same time preventing heat loss to the soil.

When the pig lies on the cement some of its body heat loss is used to heat the cement. As the layer of cement is quite thin this heat then moves downward into the airspaces between the stones. The longer a

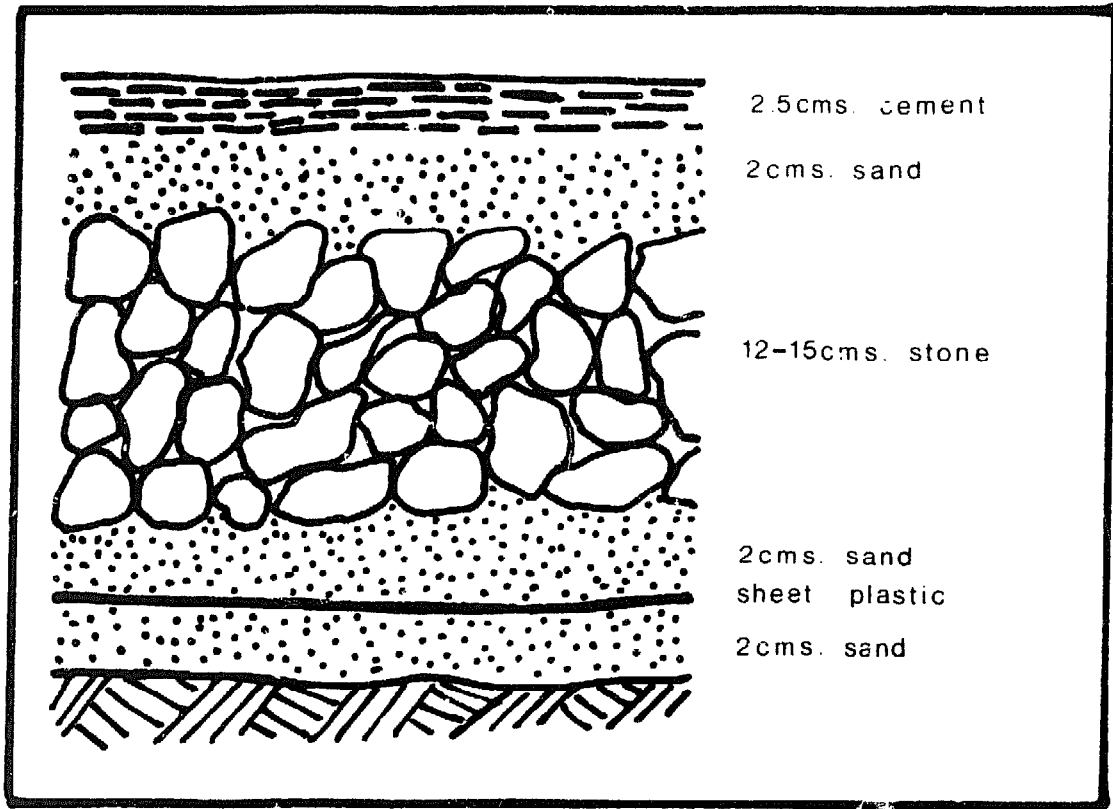

Diagram 1. Cross-section of an insulated concrete floor

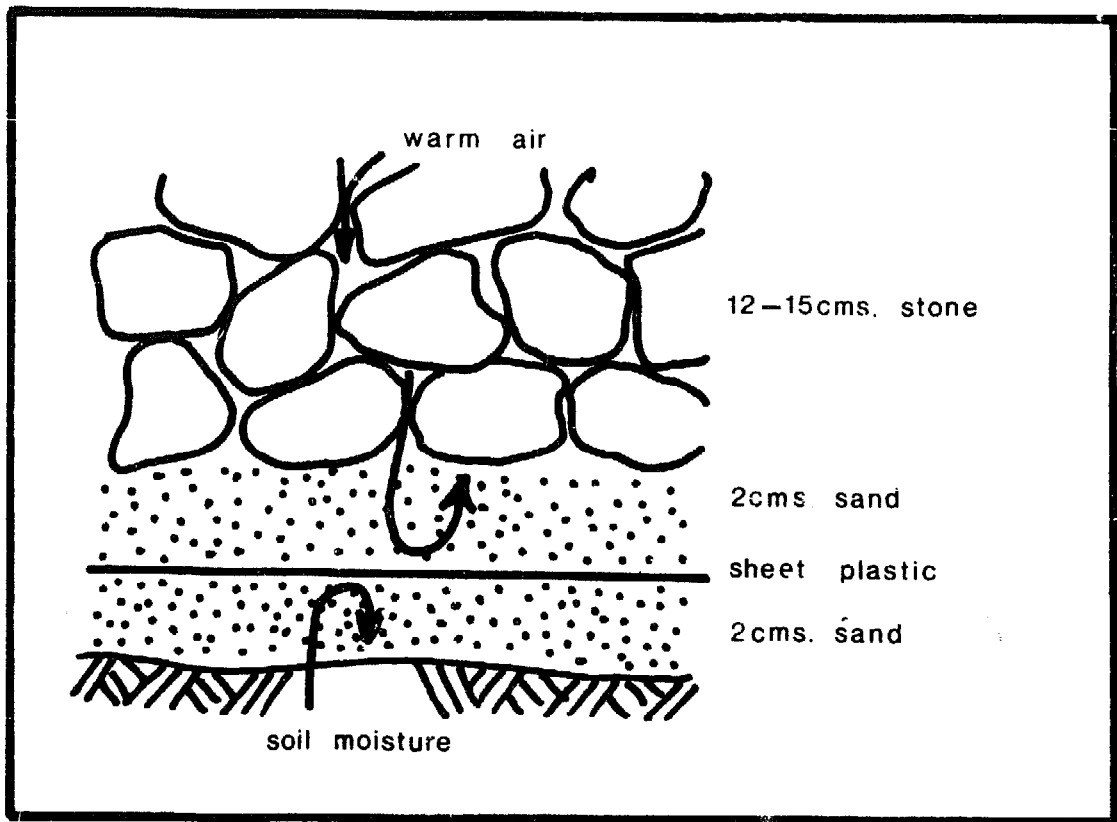

Diagram 2. The effect of sheet plastic in the insulated floor

pig lies on the floor the more heat is stored in the airspaces and the warmer the floor becomes. Stones are not the only material suited for this purpose, almost anything which can trap air beneath the cement surface is suitable. Such things as egg cartons, corrugated asbestos and beer bottles are equally as effective. The sheet of plastic prevents this stored warmth from being lost to the soil which is what would happen if the plastic were not there.

If the floor is laid correctly it will last many years and will provide a good surface for the pig to live on. The layer of cement must have no stones in it and should not be more than 2.5 cms thick. A 50 kilogram bag of cement will cover approximately three square metres of floor area to a depth of 2.5 cms.

The finish of the cement is important. A smooth surface such as that achieved by using a steel float to finish it off is too slippery and is dangerous to both the pig and the farmer. A rough surface such as that produced by levelling the cement off with a length of timber causes lameness through bruising and scratches the skin and this in turn leads to infection through the wounds. The ideal floor surface is achieved through using a wood float finish. This is neither too rough nor too smooth and provides a safe surface and comfortable surface to both the pigs and the farmer.

Deep Litter Floor

Deep litter involves the use of dry fibrous material as a bedding. It is used a lot in poultry raising but has been mainly replaced by concrete floors in the pig industry in most countries of the world. The main



Plate 5. Concrete floor surface. A wood float finish is the best surface to have.



Plate 6. A bush materials piggery in Papua New Guinea. This house has been built on the side of a hill so drainage is not a problem. The hole in the ground in front of the house is to collect the manure and water from the pens and to store it for future use in vegetable gardens.



Plate 7. An inside view of a bush materials house. The passage makes the movement of pigs from pen to pen much easier and because it is covered it is a comfortable place for the farmer to work in.

Plate 8. An outside view showing the drain which runs outside the pens.

Plate 9. A simple type of hinge. These are from old conveyor belts but similar hinges can be made from old car tyres. Note the method of keeping the gate fastened by using a rail.

advantage of deep litter is that it uses plant material which is usually available at no cost. The material is readily available, is easily handled and it is suitable as a floor for pigs. The most commonly available material satisfactory for use in Papua New Guinea is dried kunai grass (*Impereta* sp.) but other fibrous matter such as wood shavings, peanut shells and coffee hulls are equally as good. The main point to remember is that it must be dry and fibrous. The system works on the principle that dry material absorbs moisture and when this happens, under certain conditions, heat is produced. When used as a flooring system for pigs the dry material with moisture and dung produces enough heat to cause the material and dung to be broken down into a fine dust or compost. If suitably stocked and properly managed the temperature of the litter can rise to 49°C. at a depth of 10 cms. below the surface. Litter from a sawmill which treats its timber with arsenic based insecticides must not be used as this could poison the pigs.

This temperature is sufficient to destroy fly eggs and may even be high enough to destroy internal parasite eggs such as round worm eggs.

A typical deep litter system, would be to use dried kunai grass. A layer of large stones is placed on the ground and chopped dried grass is placed on top of these stones to a depth of 40 cms. The stones provide drainage as well as ventilation. The pigs are placed in the pen, at a density of no less than one pig per square metre of floor area. This density is needed to give the litter the best working conditions by supplying adequate amounts of manure, urine and body warmth.

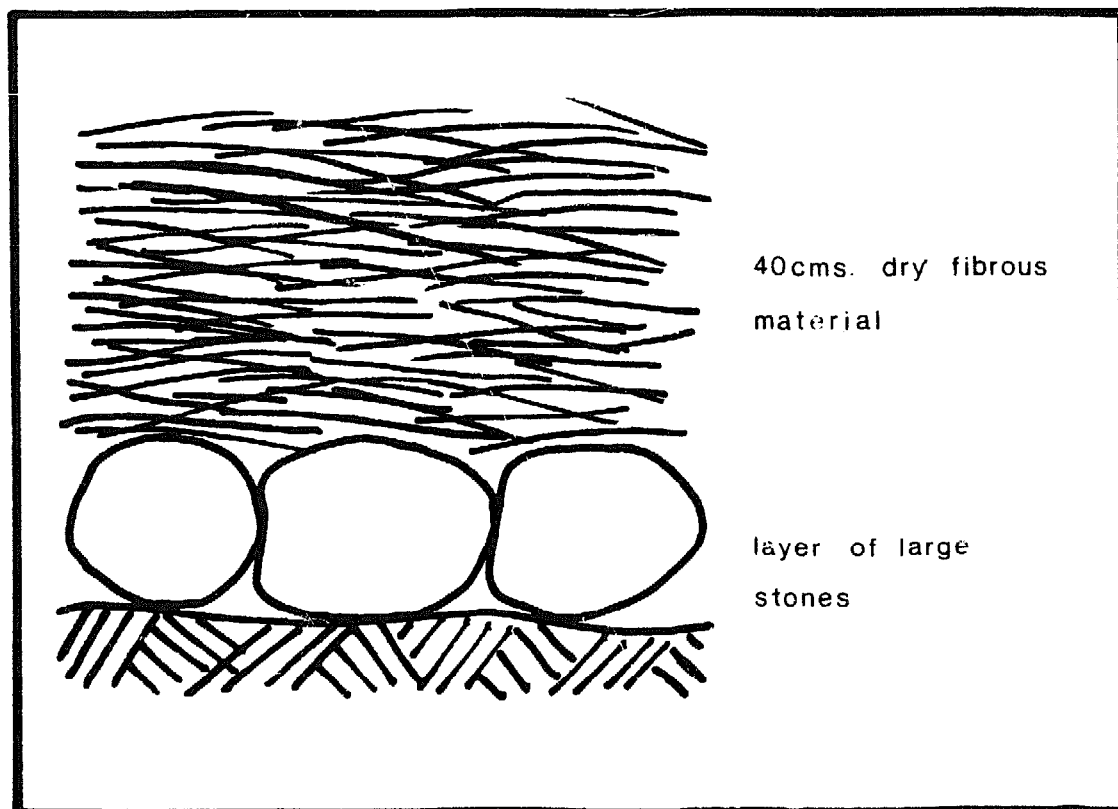

Diagram 3. Cross-section of a deep litter floor

Water and feed are placed in separate containers in the pen. Each day sufficient grass is added to cover the floor area especially the area near the water container which usually becomes very wet due to spillage. No dung, or urine or wet material is removed from the pen.

The pigs can use this litter as a floor for up to 12 months before it becomes necessary to remove it and start again. The litter builds up over a period of time, so much so that after 12 months it can be as much as one metre deep. It is therefore necessary to have pen walls at least two or two and one half metres high.

The litter is an excellent fertiliser and should be used as a mulch for vegetable or coffee gardens.

Slatted Floor

There are two main areas where slatted floors are used. These are where it is hot and in the more remote areas where cement is not available or it is too expensive to use. Slats may be used anywhere but quite often climate decides whether they are practicable or not.

On the coast slats are used to allow maximum ventilation in areas where humidity and temperature are high. By making the pigs live on slats the farmer is making sure that as much air as possible is allowed to move around the pig thus allowing the maximum area possible to be cooled by the moving air. It is for exactly the same reason that slats are not popular in the colder areas in the high altitudes where warmth is more important than coolness. In these areas an insulated concrete floor is much more effective. However, there are areas where cement is so expensive that its cost prohibits its use as a building material. Similarly, some areas do not have plains of grass available. In areas such as these slats have a place.

Where cold conditions prevail and slats are the most practical form of flooring it is advisable to include a sleeping area of dried grass on slats with a dunging area of slats only (See diagram 4.)

There are several points to be remembered when building a house with a slatted floor:

- * make sure that there are no gaps wider than 2 cm. between slats. This is especially important if piglets are being grown on a slatted floor as their legs can fall between the slats, become stuck and may even break.
- * remove all splinters from the timber so avoiding foot injuries when the pen is stocked.
- * raise the floor at least 35 cm. above ground level to make the taking away of dung easier.
- * make sure that the floor supports are strong and adequate to take the weight of the heaviest pig likely to be penned.
- * run the slats across the pen and not along it. This will make it easier for the pigs to walk about.

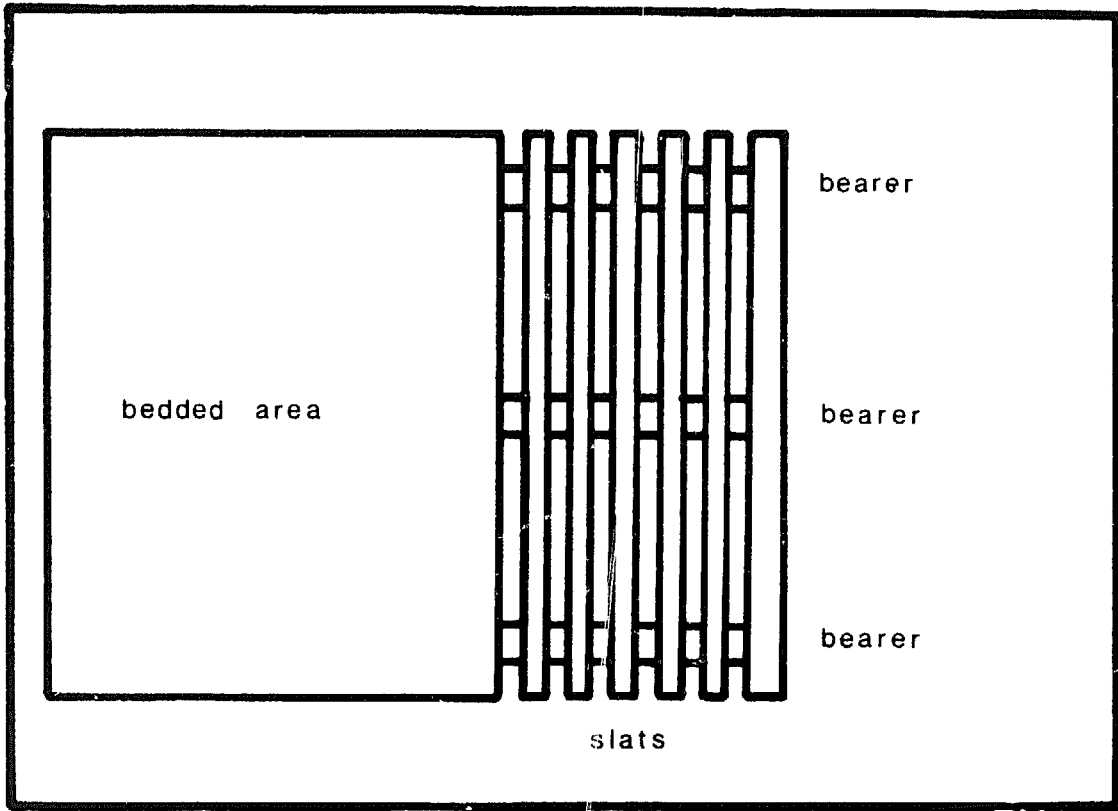

Diagram 4. Plan of a slatted floor pen with litter sleeping area

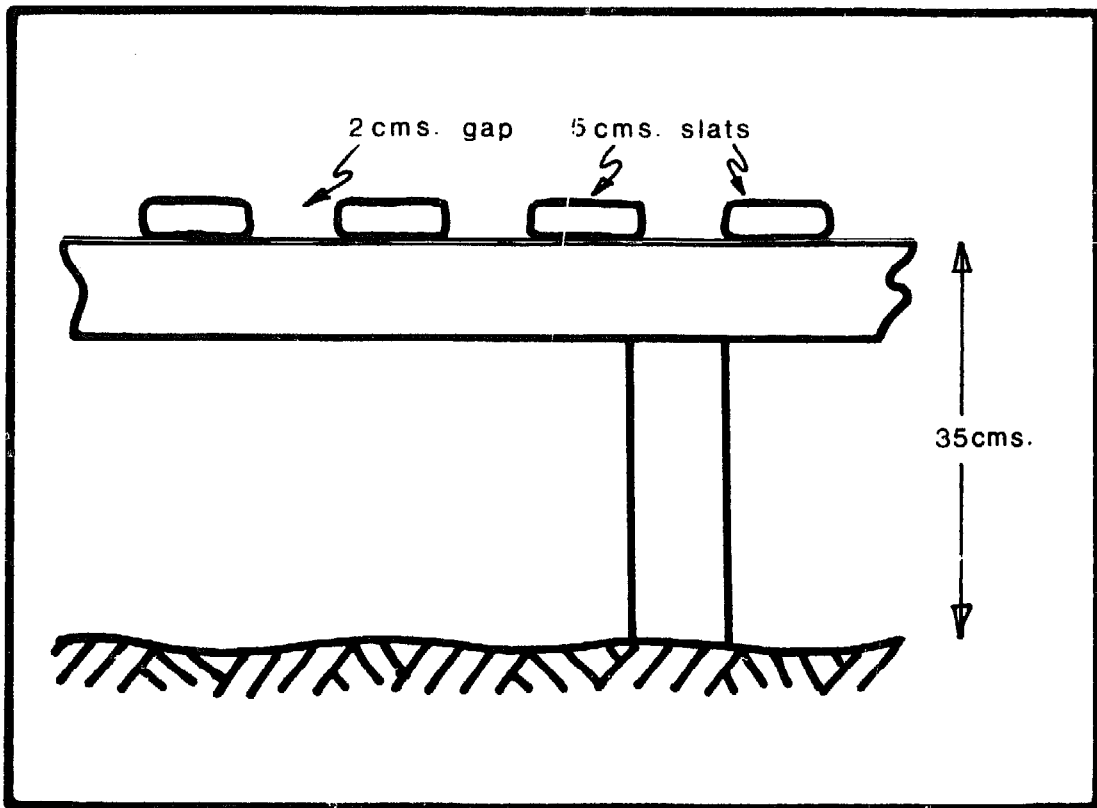

Diagram 5. A cross-section of a slatted floor

Permanent Materials Building

The most common permanent materials buildings are constructed from concrete, galvanised iron, bricks, arc mesh and steel. Of these concrete has a place mainly as flooring material in any type of piggery. The other materials however are not really necessary and can be regarded as luxuries within the industry. Galvanised iron for roofing is expensive and not very satisfactory where there is plenty of sunshine unless it is insulated inside with some form of material such as fibreglass or sisalcraft. If it is insulated then its cost is increased even more for no more advantage than that achieved by using a well constructed grass roof.

Steel is very expensive especially when freighted for any distance. It is difficult to work with in that drills and welders are required. It lasts for many years but needs to because of its high cost. Similarly arc mesh is expensive and requires more involved methods of construction than does straight timber. It is used mainly for gates and fencing.

Bricks are a luxury requiring special machinery and good quality materials. They offer no real advantages in construction unless for some reason complete isolation is wanted between pens.

It is difficult to justify the building of piggeries in permanent materials when there are adequate supplies of bush materials about.

As long as the pig is sheltered from the elements (wind, rain and sun), is provided with a comfortable environment and is easily managed then any form of housing is adequate. There is no point in paying out large sums of money to provide housing which can be obtained at little or no cost. It is worth remembering that of feeding, breeding, management and housing the latter is the least important.

Design

There are no hard and fast rules concerning pen design apart from the basic need to provide a sleeping and dunging area for the pig. In countries where large scale pig units (up to 1,000 breeding sows per piggery) are built, pen design is important not only because of the capital cost but also because of its function. In these types of piggeries there is special farrowing, weaner, grower and adult housing as each class of pig has its own particular needs.

If a pen is to house one sow then it need not be as large as a pen housing ten growers. Similarly a pen used for mating sows is much larger than that used for farrowing. The problem is to design a piggery for all classes of pigs without making it too complicated or expensive to build.

As a guide the following table will give some idea of the floor space requirements of the different classes of pigs:

<i>Class of Pig</i>	<i>Area per Pig (square metres)</i>
Sows — dry and pregnant	2.5
— farrowing	2.5
Boar — alone	2.5
— with sow	5.0
Weaners and growers	0.5–1.0
Mating pen	10.0

Table 4. Individual pen space requirements

1 Type of pen

When designing the pen consideration must be given to the purpose for which it is to be used so before any design can be started the number of pens needed must be worked out.

*** Dry sows**

As a general rule, two sows can be penned together and one or more sows can be penned with the boar in small piggeries. Where there are five or more sows it is better to keep the boar penned separately from the sows.

*** Farrowing pen**

If six week weaning is practised the farrowing pen can be used six or seven times a year which means that a three sow piggery needs only one farrowing pen; for six sows two farrowing pens and so on.

*** Grower pens**

The number of grower pens is entirely dependent upon the type of market the pigs are being grown for. A weaner project will only require one holding pen for every three sows whereas a porker project will need three pens for every three sows, assuming that each pen will hold a litter of pigs to market weight.

Example:

For a three sow, one boar piggery, producing porker pigs for sale to the local butcher the pen requirements would be as follows:

<i>Purpose</i>	<i>Number</i>	<i>Area required (square metres)</i>	<i>Measurements</i>
Boar and sow	one	10	2.5 m x 4 m
Sow	one	5	2.5 m x 2 m
Farrowing	one	2.5	2.5 m x 2 m
Grower	three	7.0	2.5 m x 3 m

Table 5. Pen requirements for a three sow, one boar, porker project

Note that the farrowing pen is actually larger than 2.5 square metres. This is because by six weeks of age the piglets will require room in which to live and move about. The 2.5 square metres stated in Tables 4 and 5 refer to the sow only.

2 Slope of floor

Floor slope must be included in the pen design. If there is not sufficient slope in the floor water and urine will collect thus making the pen unhygienic and uncomfortable for the pig to live in. Similarly, too much slope will also make the pen uncomfortable. The slope must be away from the sleeping area and should not be more than 1.3cm in 30cm. This degree of slope will give adequate drainage and is not too severe. The drain which takes the effluent away from the pen should be sited outside the pen and needs only a slope of 25cms in 300cms.

3 Walls

Also included in pen design is the type of pen walls to be used. This is not very important for adult stock apart from the fact that it needs to be strong enough to prevent movement of stock between pens. The farrowing pen however must be draught free and will usually need some form of solid sheeting or wall around the bottom of the pen. This sheeting need only be 30 to 40 cms high and should surround the pen. Solid timber, plywood or tin are satisfactory materials. Woven pitpit blind is not satisfactory as pigs find it tasty to chew and will soon eat holes into it, thereby making the pen draughty.



Plate 10. A view of the inside of a pen. Half the pen is litter for the pig to sleep on and the other half is concrete for feeding, watering and dunging.

Plate 11. An example of a farrowing pen showing a creep area which has been lined with a sack so as to provide a warm place for the piglets to sleep in.



Plate 12. Another type of creep area. Note how the piglets stay inside the creep for protection.

4 Creep area

Provision must be made in the farrowing pen to protect the piglets from the sow and also to provide an area away from the sow for feeding a high protein creep ration. This area is called a 'creep' area and can be made in many ways. The simplest creep area is made by placing a gate or partition across one corner or penning off one side of the pen.

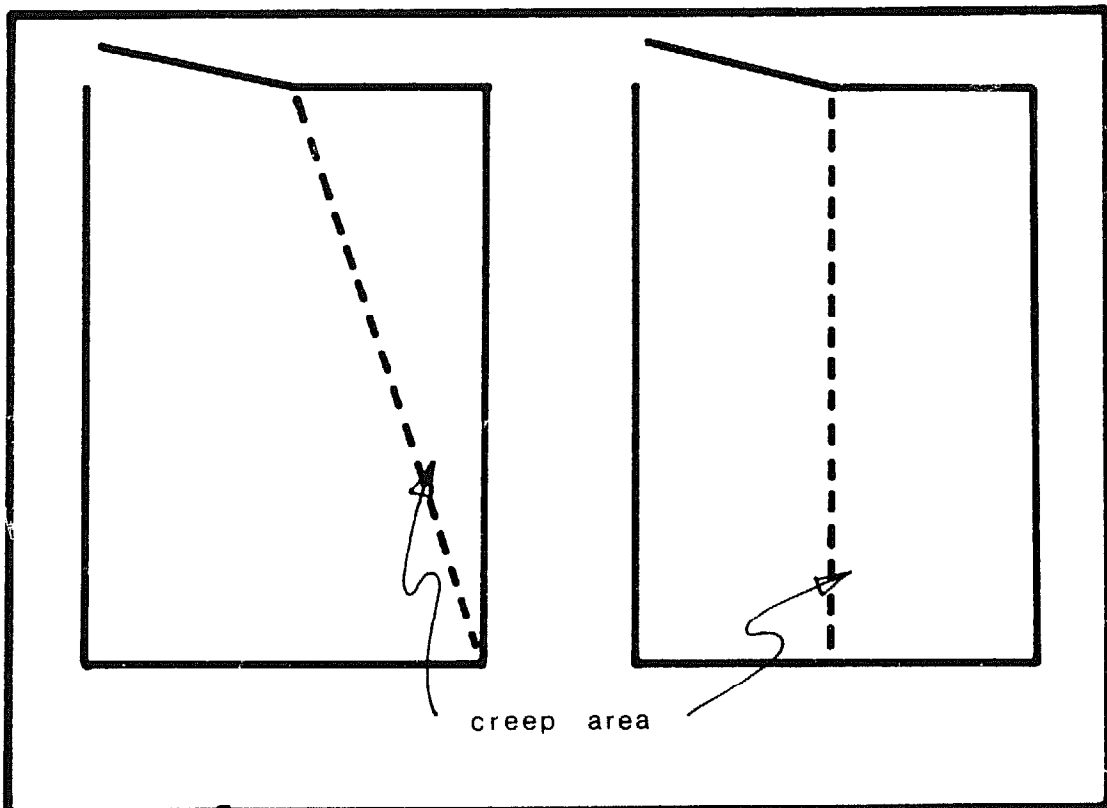

Diagram 6. Examples of creep areas

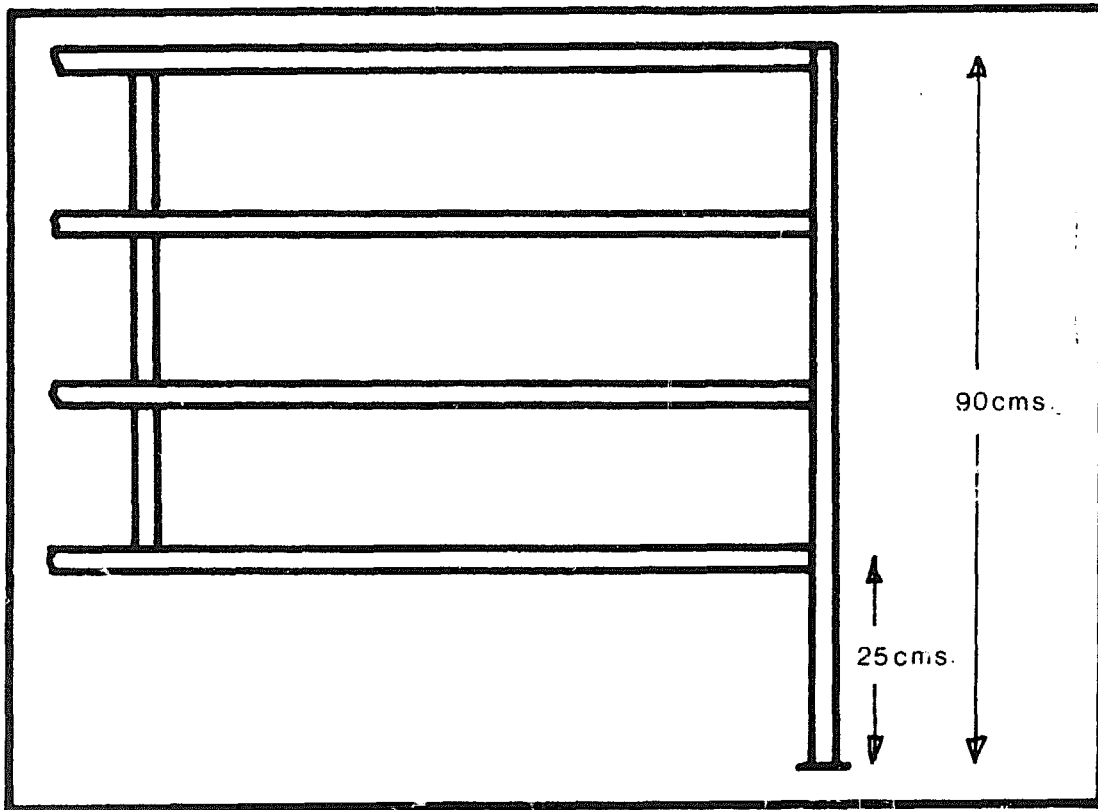

Diagram 7. Construction of a creep partition

The construction of the partition is not important except that it must make the creep area unavailable to the sow but available to the piglets. It therefore needs to be strong enough to withstand the weight of the sow against it and be high enough off the floor to let the piglets get underneath. Diagram 7. shows an example of how a partition can be constructed.

5 Crates

An alternative is to lock the sow into a crate so that she only has enough room to stand up and lie down. The main advantage is that the sow must lower herself down slowly thus reducing the chances of crushing the piglets and that they do offer a readymade creep area by virtue of the fact that the sow is locked in and cannot move about. If a crate is to be used then some changes to the basic pen design will be needed. It is necessary to have the head of the sow at the highest point of the floor and the rail near the drain. If the sow is the other way around the dung and urine will flow through the pen thus making messy, unhygienic and uncomfortable living conditions for both the sow and the litter. To get the tail to drain position it is either necessary to have a 'walk-through' type crate with two gates in the pen walls or to be able to back the sow into the crate. Of the two, the 'walk-through' takes a little more time and effort to construct but is easier to manage. The following diagram illustrates the 'walk-through' system.

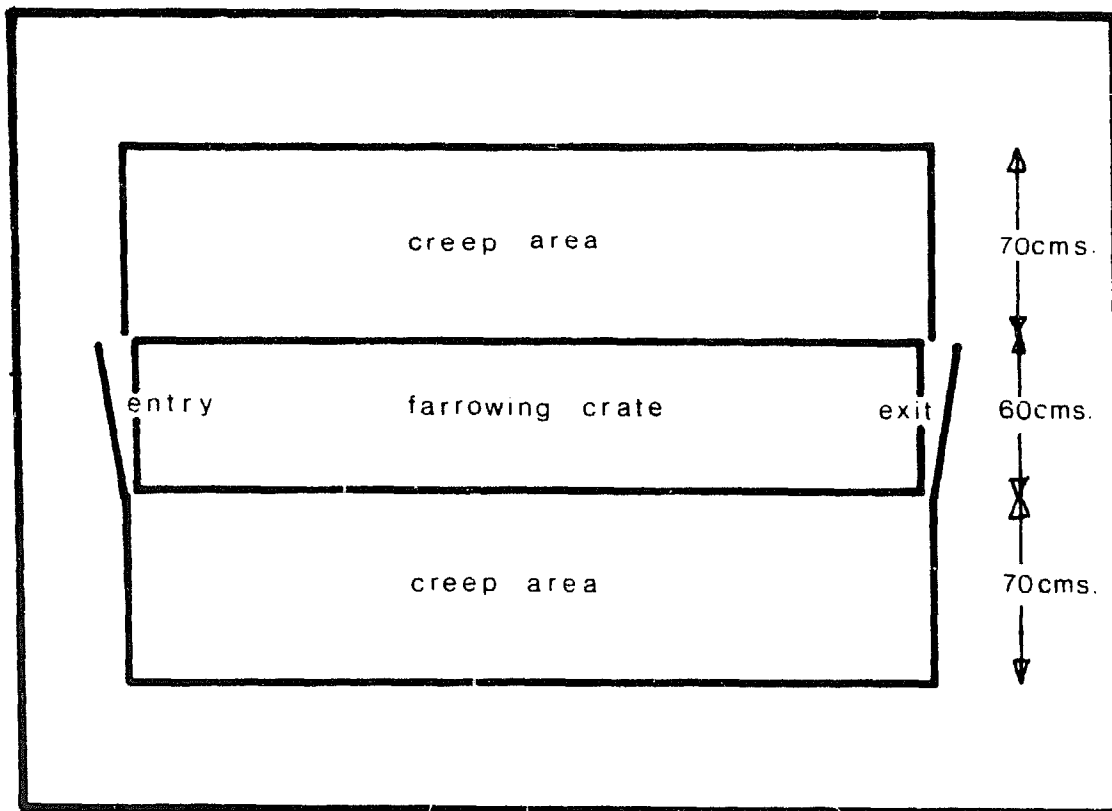

Diagram 8. A 'walk-through' farrowing crate and pen

A suitable design for a farrowing crate is as follows. This same design may also be used as an isolation and treatment crate.

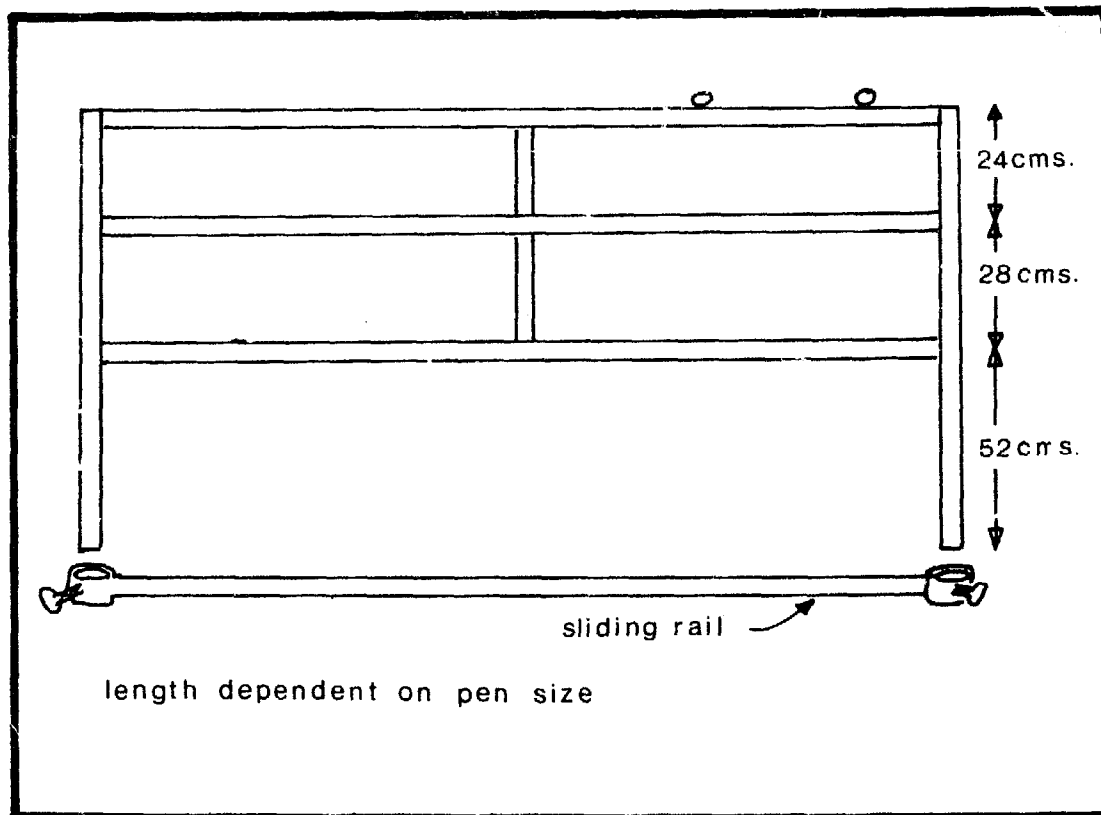

Diagram 9. Crate design

Material used for the construction of the crate can be either timber or steel. Of the two steel is better as it is stronger, is easier to clean and is more lasting.

Layout

There are two main considerations when deciding upon the layout of a piggery. One is hygiene and the other is ease of management. The two are really related in that they tend to depend upon each other. A good manager is aware of the hygiene aspect of his work and so takes this into consideration when planning his management practises.

The main point about hygiene to be borne in mind is that older stock are more resistant to infection than are younger stock. This means, in effect, that young and old stock should be kept apart from each other. While this is basically a management function the farmer cannot do much about it if his farrowing pen has been built next to his boar pen. If the piggery is a small unit with all the pigs in the one building it is best if the farrowing pen is built at one end, the boar pen at the other end with the pens between graded so the pigs move toward the boar pen as they get older.

This reduces the possibility of piglets becoming infected with illnesses which have little or no effect on the older stock but which could be fatal to the piglets.

Another important practice is to build the drains outside the pens and running away from the young stock. By placing the drains outside the pens the possibility of disease spreading from pen to pen is reduced and it also allows more room inside the pen. Similarly the slope of the drain away from the farrowing pen means that the young piglets are given every opportunity to grow as quickly as possible by keeping the chance of infection as low as possible.

These two aspects of layout are easily achieved with little or no inconvenience yet they are important features of pig housing.

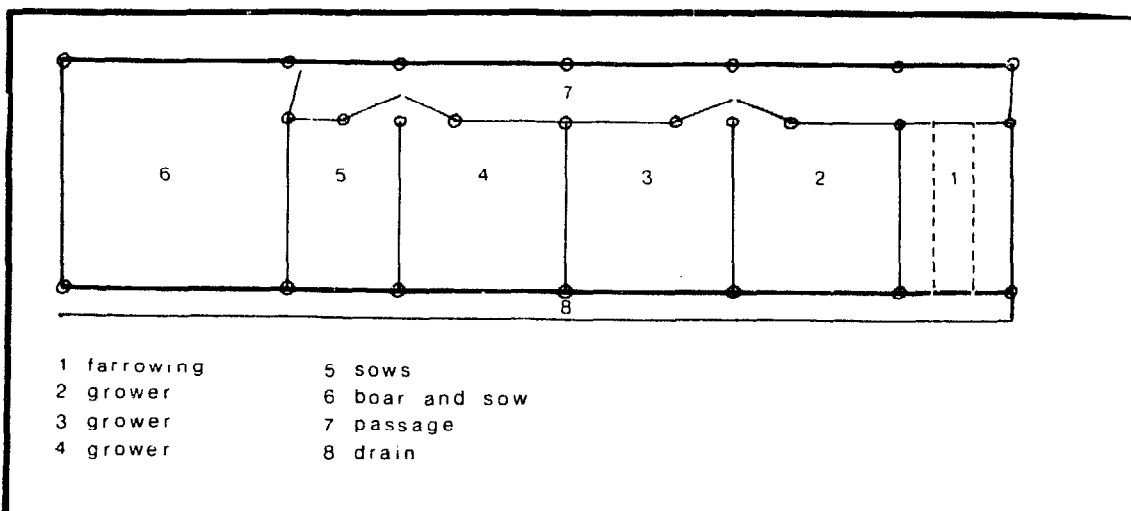

Diagram 10. A floor plan suitable for a 3 sow, 1 boar breeding/fattening unit

4 Breeds

There are many breeds of pigs throughout the world, but only some of them are in any particular country. This does not mean that the pigs which are in a country are the best available: it merely means that they have proven successful.

1 Bush native pig

There is estimated to be 1.5 million native pigs in Papua New Guinea and approximately 65 per cent of these are to be found in the highlands districts. It is a short dumpy animal with a coloured coat. It has short erect ears, long narrow head, broad shoulders and light hind-quarters. The broad shoulders are used to get into bush and jungle and are very strong. It is a very smooth walker with feet which, by western standards, appear to be broken down. It is a slow growing animal with a maximum yearly liveweight gain of about fifty kilograms on an improved village diet (under intensive conditions with good feeding it is capable of seventy five kilogram liveweight gain per year).

The sow is a very good mother who looks after her young very well. The average litter size is about four or five weaned with one litter produced every twelve to eighteen months. The piglets are very small at birth and might weight five kilograms at two months of age. The sow usually loses much condition during lactation and normally needs a period of fattening before mating again.



Plate 13. A bush native boar

The carcass is very fat with little meat but is keenly sought after at traditional celebrations.

The native pig is ideally suited to its environment and traditional management practices. It is a hardy animal which has developed over the years to its present state which would be difficult to improve.

2 Berkshire

The Berkshire is a widely spread breed. It is a large meaty pig with erect ears and white hair on the legs, tail and face, the rest being black. Like all British breeds it moves with a stilted walk when compared with the native pig. This is partly caused by its long body and the fact that it walks on its toes rather than its feet. Its forequarters are not as well developed as in the native pig, but its hindquarters are much bigger and meatier.

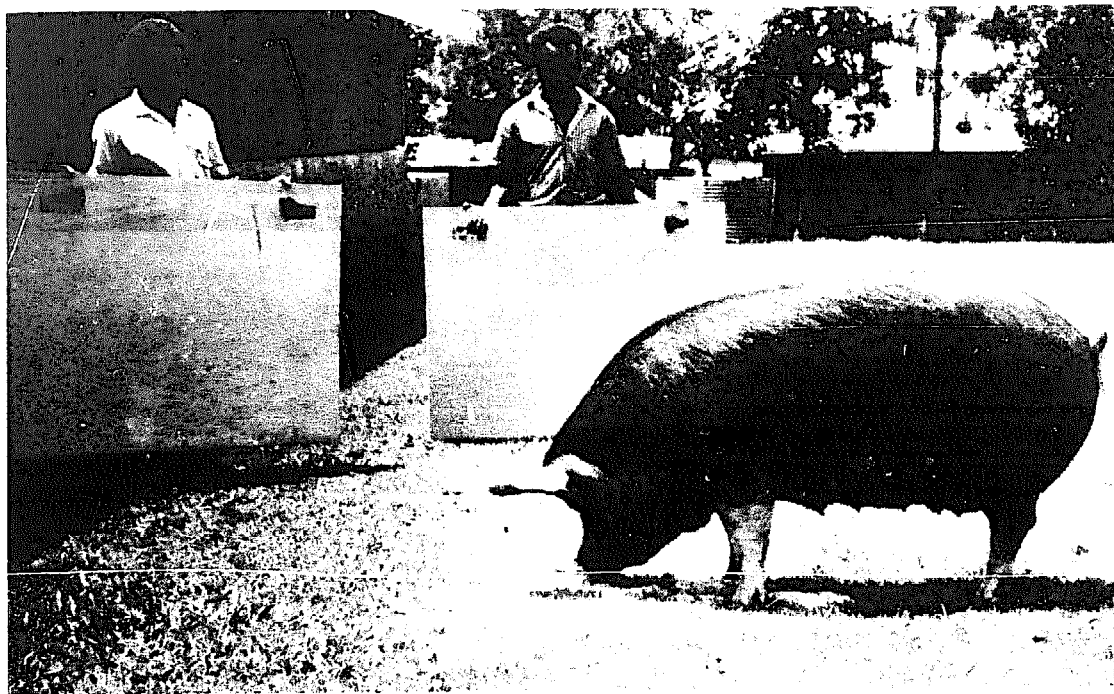

Plate 14. A Berkshire sow. Note the plywood boards used to shepherd pigs about.

The sow is a very good breeder producing regular and large litters of nine or ten or more under good management conditions. She is also usually of quiet nature and is a good mother producing strong, healthy and large piglets of up to fifteen kilograms weight at weaning.

While it is unlikely that Berkshires will survive under normal village conditions they do stand up to poorer than average management better than many breeds.

3 Tamworth

The Tamworth is a well-known breed, mainly because of its red colour and long, narrow snout. It is a large red pig with erect ears and a head not unlike the native pig. Where the Berkshire has a 'dished' face the Tamworth has a long straight face. This has led to the popular belief

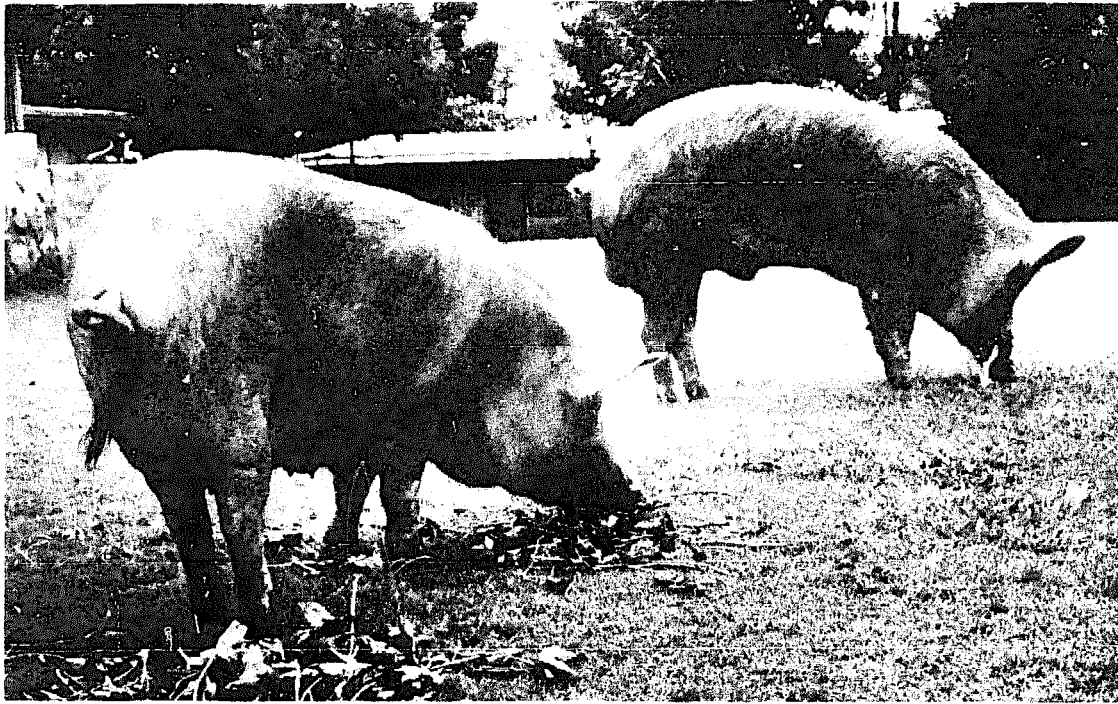

Plate 15. A pair of Tamworth pigs

that it is a better pig for extensive grazing because it can supposedly root and dig up ground for itself. The Tamworth breed is recognised in Australia and other countries as being perhaps the hardiest of the breeds but this is not because of its nose.

The sow is quite a good mother producing reasonably large litters of about eight or nine regularly.

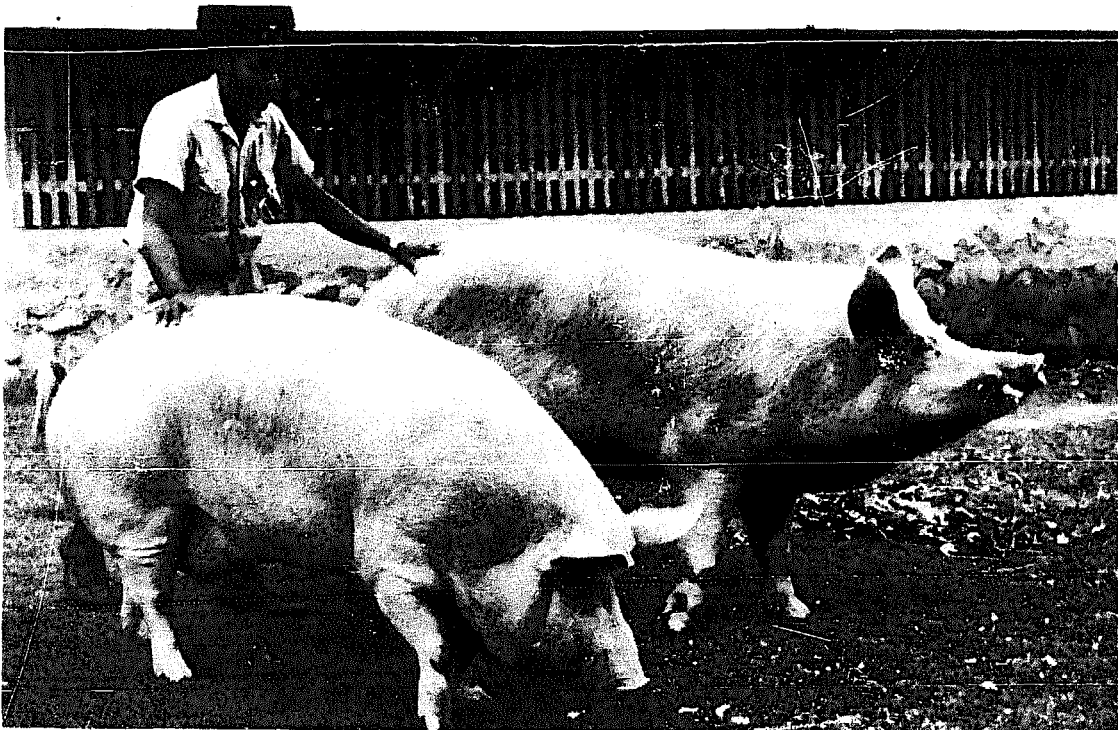

Plate 16. A pair of Large White pigs

4 Large White

This is the most popular breed of pig in the world today but it is definitely not suited to anything but intensive production under good management. It has been bred to take advantage of high levels of management and is difficult to better under that situation. Because it is so highly, and selectively, bred for performance at high levels of management it is not suited to the lower levels. As a pure white pig it is very easily sunburnt which can be quite severe in tropical areas. The Large White is a very good breeder with litter sizes of over ten not uncommon. It is a long pig which, under good management and feeding, produces carcasses with plenty of meat. It has erect ears and a straight snout. It is a fast and efficient grower which makes it an ideal pig for a crossbreeding program.

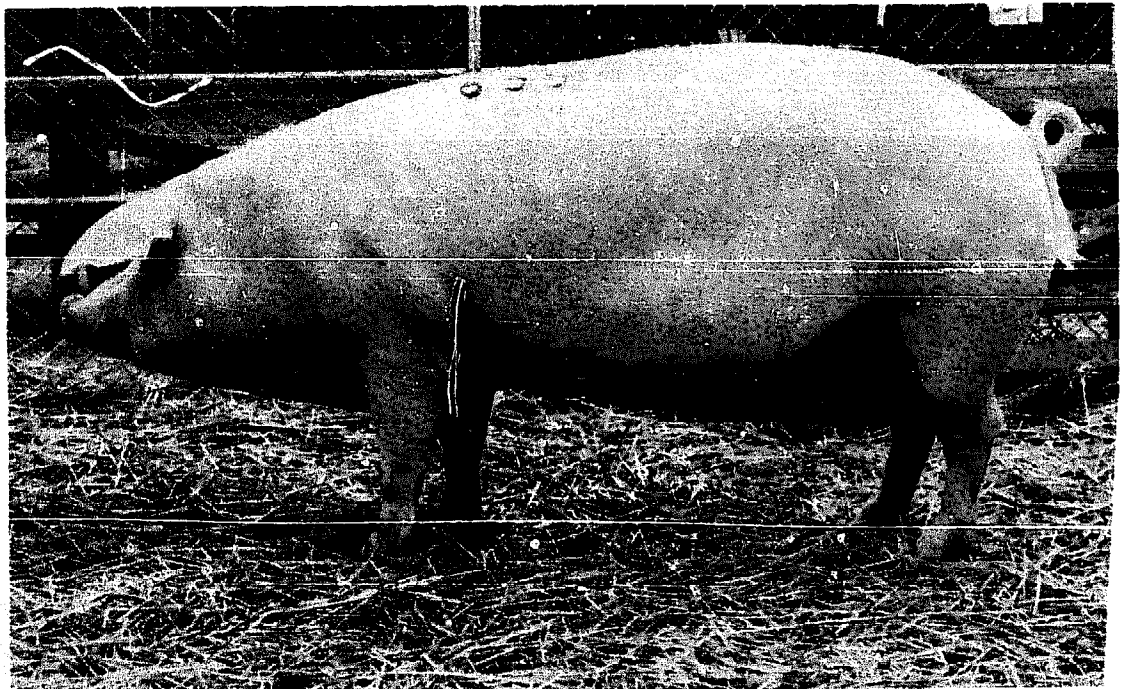

Plate 17. Landrace pig

5 Landrace

While there are not many Landrace in the tropics it is an important breed for the production of quality bacon pigs.

It is smaller than the Large White but has much larger hams. Its main characteristic is its large floppy ears which fall over its eyes. This feature, with its white colour, makes it extremely easy to sunburn. It produces large well grown litters but, like the Large White, it needs a high level of management to be successful. Its main use is in a crossbreeding program for the production of bacon pigs.

6 Wessex Saddleback

The Wessex Saddleback is easily recognised by the distinctive white 'saddle' across its shoulders with the rest of the body being black.

It is a relatively slow maturing animal but is an excellent mother which produces plenty of milk. It tends to run to fat quickly and is mainly used as a crossbred mother. It has large, black floppy ears, is shorter than the white breeds but is usually a much more placid sow.



Plate 18. A Wessex Saddleback pig

7 Large Black

Like the Saddleback and Landrace, the Large Black has large floppy ears which fall over its eyes. There are not many purebred Large Blacks available now mainly because of the belief that a pig with floppy ears could not see to walk around and was therefore likely to injure itself.

It is a large pig which is a slow maturer and runs to fat quickly. It is also a very good mother.

8 Crossbreds

Although not strictly a breed of pig there are many crossbreds about. Not only are purebred British pigs crossed between themselves, native pigs are also used. Probably the most important and most popular crossbreeding on piggeries in Papua New Guinea is between the Berkshire and Tamworth and the Berkshire and native. Both are good breeders which produce good litters with the Berkshire x Tamworth slightly in front with heavier weaning weights. With the wide variety

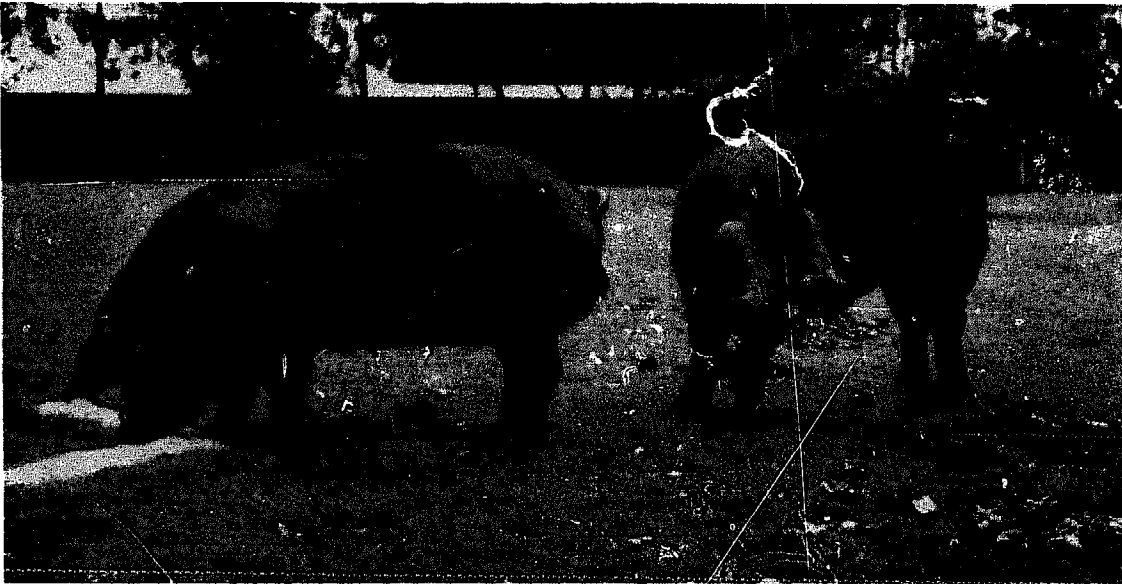

Plate 19. A pair of Large Black pigs

of breeds available there are many different crossbreeds which can be bred. Some are more useful than others depending upon the type of pig wanted.

Cross breeding is generally practised when no single breed of pig is suited to the farmer. For example, a person living in a town wants to be able to buy pork which has plenty of meat and not too much fat. Some people may even want to buy meat from a white pig only and not a coloured one which is another market taste which must be catered for. Other people might prefer their pigs to be coloured and very fat. These are two different situations requiring two different types of pigs but the management and general business skill required from the farmer is the same in each situation.

Both farmers want a fast growing pig which can grow well. They also want a pig which will produce many litters of large numbers of piglets but which can also stand up to harsh management conditions.

To fill these various needs a crossbred pig may provide the answer. The town producer wants a white pig so he must have either a Landrace or Large White pig. He may not like the Landrace because its ears may be easily sunburnt so he may decide to use a Large White. This will give him a large quick growing and white pig. He may decide upon a Berkshire sow as the mother because she is a good mother, has a good porker type body and is a fast early grower. By crossing these two breeds the farmer will meet all his needs which he found difficult to find in one breed. Added to this he will get a faster growing animal than either of the two parents so long as each of the parents is a good quality animal.

The other farmer has to keep his pigs for a longer period because his market wants large fat pigs. He wants a coloured pig so that demand

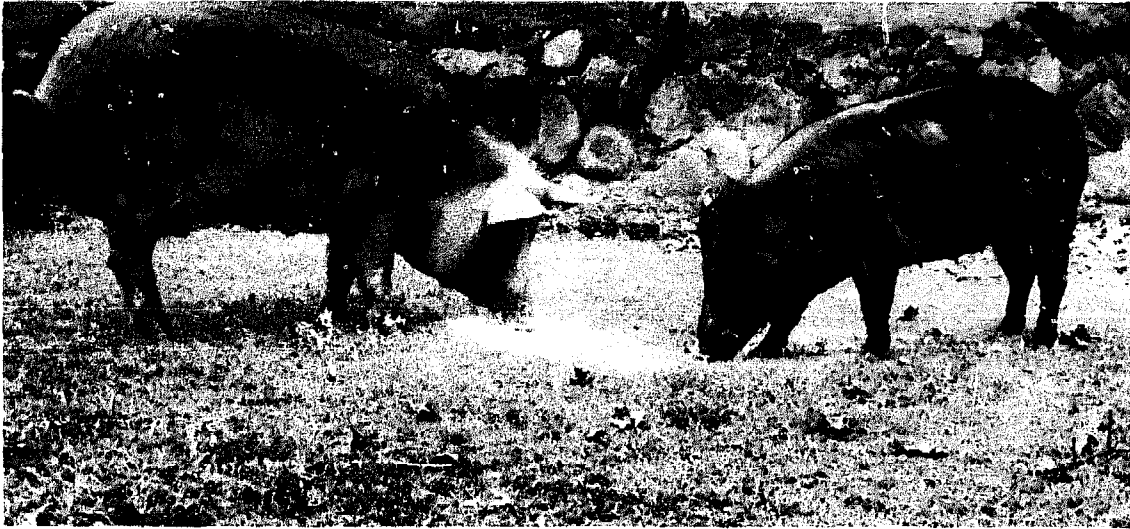

Plate 20. Tamworth sow and a bush native sow of the same age. Note the difference in size even though both pigs have been raised in the same piggery on the same feed.

leaves out all the white breeds. He wants his pigs to be hardy and strong in case the buyer wants to grow more fat on the pig before it is killed. This means that the farmer will probably include the local native pig in his crossbred. He also wants his sows to be good mothers who produce and rear large litters. He may select the Wessex Saddleback to cross with his native pig to produce the sows he wants or he may simply buy one from a nearby farmer. He now has a half saddleback half native brood sow which he mates to a Tamworth boar to get a large pig with some red colour. This crossbred will also grow quicker than any of the parents as a result of crossbreeding them.

There are many different forms of crossbreeding but the important point to remember is that the main reason for crossbreeding is purely economic and that the type of crossing depends upon the economic factors operating at the particular location and time.

5 Sow, Boar and Grower Management

1 Selection of Breeding Stock

The success of a piggery will, to a large extent, depend upon the ability of the breeding animals to produce not only large numbers of growers, but also quality stock. It is very important that the base breeding herd consist of quality stock which will reproduce their best features in their progeny. The selection of the breeding stock is therefore of major importance.

Sows

The sow has one function in life and that is to produce piglets. She has no other function, and when she is either not pregnant or lactating, she is costing the farmer money from which he gets no profit.

It is better if the sow come from a large litter as this increases the chance of her having large litters herself. She must be big and well grown for her age, which shows that she will produce piglets which will grow quickly. Feet and legs need to be strong so she can carry large litters during pregnancy without harmful effects. She should have at least fourteen teats which are evenly spaced with three pairs in front of the navel. This means she is capable of producing plenty of milk in each "quarter", and that there is enough room for a large litter to feed. Of course, she should also be in good health and free from disease.

Boars

Exactly the same conditions of selection apply for the boar, but he must be more carefully selected than the sow. More care must be taken because a boar can produce up to twenty times (or more) the number of piglets than any one sow can, thereby making it very important that he does not have any economic defects which can be passed on to his progeny. An important selection point is fitness. A boar has only one function in life and that is to get sows pregnant. To do this he must be both fit and active. He must also have strong legs and feet as he does all of his work standing up. Naturally he must have two testicles.

There are several general points of selection which should be followed.

- * It is a good idea to select the breeding stock at the age when their progeny will be sold. This will give the buyer some idea of what the progeny will look like at the time they are sold.
- * Where possible, check the records of the parent pigs to see how they have performed as breeders. Too many people buy the first pig they see and are disappointed when they do not produce large litters. This can be overcome by examining the production records of the pigs.
- * Make sure that the sows and boars are not related. Some people practice line breeding which involves the mating of closely related animals. Line breeding is a very demanding system of breeding used by people who usually have had many years of experience in breeding livestock. It is better to use unrelated stock so avoiding the possibility of harmful breeding.
- * Always ask to see the litter mates of the pigs being bought. This will quite often give some idea of the type of breeder the boar was and also the uniformity for both body type and growth.
- * Finally, do not be afraid to have the pigs inspected by a veterinary officer or livestock officer of the Department of Agriculture for general health. These people are trained in livestock health and their help could stop a sick animal from being sold.

2 Sow and Boar Management

Until sexual maturity the management of both sows and boars is identical. They should be kept separate to prevent any unwanted pregnancies. They must be kept growing as the farmer must mate them as early as possible. Good housing, plenty of the right foods and a continuous supply of fresh cool water will result in well grown and healthy stock.

Sow management

Sows generally are sexually mature at about eight months or 90 kilograms liveweight, depending on their breeding and rearing. Crossbred sows can mature up to one month earlier than pure breeds while some pure breeds mature earlier than others. Oestrus in sows occurs every 21 days and it is good practice to mate sows which have not had a litter on their third oestrus as it is at this time that the maximum number of ova are being produced by the ovaries. If the sow is mated earlier than the third oestrus she is more likely to produce a smaller litter than if she had been mated later.

Boar management

Boars generally reach sexual maturity earlier than sows. A boar can be capable of mating at six months of age, but it is a good idea to let him grow to seven or eight months before he begins serious mating duties. Care should be taken with early matings as an unhappy experience at this stage could affect the working life of the boar. He should be mated with older experienced sows who will not attack him if he is over keen. He should also be used sparingly at first and should not be mated more than once every ten days for the first month or so, as he gets older he can be used more often, but periods of rest are desirable to keep him in fresh condition.

It is also a good idea to prevent the boar from getting too heavy as he grows older. This is merely a matter of management but health must not be sacrificed for size.

3 Mating

To obtain the best possible conception rates, sows should be mated twice within a twelve hour period. This way each ova is then given the best possible chance of becoming fertilized, so producing the best possible conception result. The easiest way to achieve this is to hand mate all sows. In the past, sows have usually been turned into a paddock with a boar and it has been left to nature to do the rest. The result was that farmers often did not know when sows were expected to farrow, often did not pick up unproductive breeders until they had been feeding them over a period of months before realising they were not pregnant and did not get maximum conception rates.

Handmating removes many of the uncertainties associated with breeding sows.

The sow is penned with the boar when it is known that she is ready and willing to take the boar. This can be easily found out by the farmer placing pressure on the back of the sow over the last few ribs with his hands. If the sow stands still she is ready to take the boar. She should be penned with the boar and the farmer should stay and watch the mating.

It is not unusual for some help to be given to a young and inexperienced boar that is over eager. The farmer can guide the penis into the vagina by holding the sheath thus making sure of a successful mating. As soon as the mating is completed the sow should be returned to her pen and allowed to rest. Similarly the boar needs rest especially if he is to be used again within twelve hours on the same sow. Approximately twelve hours later the mating is carried out again.

By actually seeing, and in some cases, helping the matings, the farmer knows that his sow has been mated and can work out the approximate farrowing date by adding 114 days or three months, three weeks and three days to the date of mating. He can also check his sow again in 21 days to see whether she has come into oestrus again which would mean that the mating was unsuccessful.

To assist maximum conception, sows should be mated in the early morning and late afternoon in tropical areas. Mating during the heat of the day can adversely affect the performance of the boar and the quality of his semen. It is also a good idea to provide a soft floor such as coffee hulls, woodshavings, sawdust or sand for the pigs to mate on. Concrete floors sometimes become slippery or too rough and sharp and are always tiring to stand on for any length of time.

It can be seen from these points that every effort should be made to provide an ideal environment for mating sows and boars. Attention to these points will give the animals every opportunity to produce as many pigs as they are able.

4 Culling

At some time or other it is necessary to remove a breeder from the herd. Removal of breeders from the herd for any reason except death is called culling. Animals are culled for many reasons among which are disease, age, infertility, temperament and injury.

The most common reason for culling sows is lack of productivity and infertility. It has been noted before that there is only one purpose in life for a sow and that is to produce piglets. If she cannot produce enough to make a profit for her owner, or if she cannot produce any, then she must be culled — and should not be sold to another pig farmer.

There is one exception to this rule — gilts which have not performed well with their first litter should be given a second chance to prove their worth. There are several reasons why a gilt may not produce a good litter at her first try. Because of these reasons a gilt should not be judged too harshly, but should she fail a second time, she must be culled. The main reason for giving gilts a second chance is that their bodies are undergoing a completely new experience with their first pregnancy. They are unaware of what is happening to them, can become excited and frightened at farrowing, may not produce much milk at first and may have a tough time at farrowing. All these things can prevent a sow from weaning a good litter, but it is likely that by the second farrowing she is more prepared for the events which occur and will be able to handle the situation much better. As sows get older they tend to become better mothers in that farrowing and lactation

become normal and regular so the strain is not as great as it is for the first farrowing.

A sow has to produce enough piglets to offset her cost of keep, a proportion of the costs of keeping the boar and to make a profit as well. It is generally considered that a sow will need to wean approximately six piglets per year to pay her way in an intensive commercial piggery. Any number over six makes the piggery that much more profitable.

Some suggested recommendations for culling are:

- * Gilts not pregnant by 12 months of age should be culled as non-breeders.
- * Boars unwilling to mate or boars unable to mate must be culled.
- * Sows which do not average six weaned per litter after the first litter should be culled.
- * Sows not pregnant within three months of weaning should be culled.
- * Sows should be culled after six litters unless they are very good producers.
- * Boars should be culled every two years to prevent in-breeding (mating related pigs).

The last two points are quite important ones. Sows usually reach their maximum productivity by the fifth or sixth litter and this level drops after that stage has been reached. Of course, some sows are not like this but they are not many. It is expensive to feed a sow for her 114 days of gestation and 42 days of lactation if she weans only five piglets on her seventh litter. It virtually means that the farmer has fed the sow for six months only to make a loss on her production.

Unless a sow has produced very good litters in the past and has more than paid her way, it is a good management practice to cull all sows after they have had six litters.

This means that, in effect, the farmer will be culling approximately 33 per cent, or one third, of his herd each year. If this is done thoroughly and conscientiously, he will be upgrading his herd all the time as he will be culling the worst third of his sows each year.

As long as the farmer selects quality replacements (which should be better than those he is culling) he will find the productivity of his herd improving all the time. This improvement is slow, but in the long term it is worth it.

Culling must be done properly and must be done on past performance not on personal likes and dislikes. Many farmers allow themselves to be influenced by their families, and themselves, when it comes to culling unproductive sows. There are many instances where fat and barren sows are eating their heads off merely because they are the

favourite of the farmer or his wife. There is no room in commercial pig production for personal likes and dislikes to influence economic management decisions.

5 Farrowing Management

It is very rare that a sow needs help at farrowing, but she does need warm and comfortable conditions in which to farrow.

Ideally, the sow should be drenched with a worming powder one month before the expected date of farrowing. Approximately one week before farrowing she should be sprayed for lice and given a thorough wash and scrub before being moved to the farrowing pen. By doing this, the farmer makes sure that the sow is clean both inside and out, thereby giving the newborn piglet every protection against parasite attack. By placing the sow in the farrowing pen a week before farrowing, he is giving her time to become used to her new surroundings and gives her time to settle in. The pen must be warm and dry with plenty of fresh clean water and an adequate supply of good quality food.

Approximately 24 hours before farrowing, the udder will start producing colostrum and this can be seen by gently massaging the teats. This is a good sign of when a sow is ready to farrow. Another sign is that the sow will become restless and will nose about the pen. If there is any bedding in the pen she will try to make a nest to farrow in.

When the signs are that she is due to farrow, the farmer should keep a close eye on her just in case he can do something to help. If he has been handling his pigs the way he should have, the sows will not usually resent his presence, but if they do, he should still keep a close eye on the proceedings whilst at the same time not upsetting the sow.

Farrowing can take as little as two hours or as much as 12-18 hours. Naturally, the farmer cannot be there all the time, but he should make regular visits to see the sow and her piglets. As each piglet can cost up to \$8 - \$15 "get on the ground" it is vitally important that every precaution to prevent deaths be undertaken.

Occasionally, piglets are born with mucus in their mouths which hampers breathing and may cause death through suffocation. The farmer can remove this mucus with his finger.

Membranes over the nose and mouth are another cause of death at farrowing which need not occur if the farmer is attentive at farrowing time.

6 Management Practices

There are some aspects of pig production which, while they are not necessarily important economically, are nevertheless good management practices to adopt. Some of these practices are done to help later management (earmarking), for health reasons (treating the umbilical cord and cutting the eyeteeth), to cater for consumer demand (castration) and for economic analysis (records). Each on its own may not be important for the success of the business, but when combined, form an important part in the profitable production of the pig meat.

1 Stock Identification

Traditional ways of identification of pigs by villagers have involved the docking of tails and ears and the memory of the owner. While the second method is most unreliable, the first is usually quite successful until two similar animals with the same marks are found together. The success of the docking system can be mainly due to the relatively small numbers of pigs any one owner possesses.

Not only is it important for owners to be able to positively identify their stock to settle ownership disputes, it is also desirable for the progressive farmer to be able to record the performance of his stock. Unless he can positively identify each and every pig, there is no way he can do this with any success.

There are three methods available for farmers to identify their stock.

Ear Tags

Ear tags come in many different shapes, sizes and colours and all cost money. Some tags have numbers engraved on them while others need the numbers to be painted by hand. All need some form of equipment to place them in the ear of the pig.

The main problem with tags is that they are sometimes lost. Once this happens there is no positive means of identification left. To overcome this problem it is necessary to place two identical tags in the ears so that if one is lost the other remains. If this system of identification is used the remaining tag must be removed and two new tags put in with the new numbers being recorded in the record system. If hand-painted tags are used it merely involves the painting of a tag the same as that which remains and putting this into the ear.

For pigs which have erect ears, it is a good idea to place the tag so that the number can be read from the front of the animal; in other words, the number is facing out from the inside of the ear. With pigs which have floppy ears, the tag must be placed with the number outside the ear, so that it can be read without having to lift the ear. When placing the tags in the ear, care should be taken to ensure that it is in the centre of the ear and not too near the edge otherwise it will tear out quite easily.

Tags are generally a satisfactory means of identification but it should be remembered that they are easily removed if anyone wants to remove all signs of identification.

Tatooin

All stud pig societies in Australia require purebred pigs to be tatooin in the ear as a positive means of identification. For commercial producers tatooin is impractical because equipment is expensive, it is difficult to do properly, and it is not successful for rapid identification as it usually involves the cleaning of the ear before the tatooin can be read.

Until the time arrives when stud pig societies are formed tatooin is unlikely to be used to any great extent.

Ear Notching

Ear notching involves the removal of pieces of the ear with special pliers in certain positions which relate to a defined numbering system. It is a common means of identification in many countries and there appears to be no reason why it cannot be used in the South Pacific. Pigs can be notched at any age, but if done at a young age they are easier to handle. The pliers take a piece of skin and a piece of the ear cartilage out leaving a shape in the ear. Depending on where this shape is, so the number of the pig is permanently set. Figure 11 shows the position for each number.

By using such a system as is illustrated here, anyone can read the number provided the system is commonly used. Figure 12 illustrates several numbers.

The system can number up to 1599 then reverts back to number one again by which time the original early numbered pigs would have long been gone from the herd.

The main advantage of ear notching is that it is simple, easily understood and is not easily removed in the case of theft.

2 Farrowing Operations

There are two management operations which can be usefully used at farrowing. These are treatment of the umbilical cord and cutting of the eyeteeth.

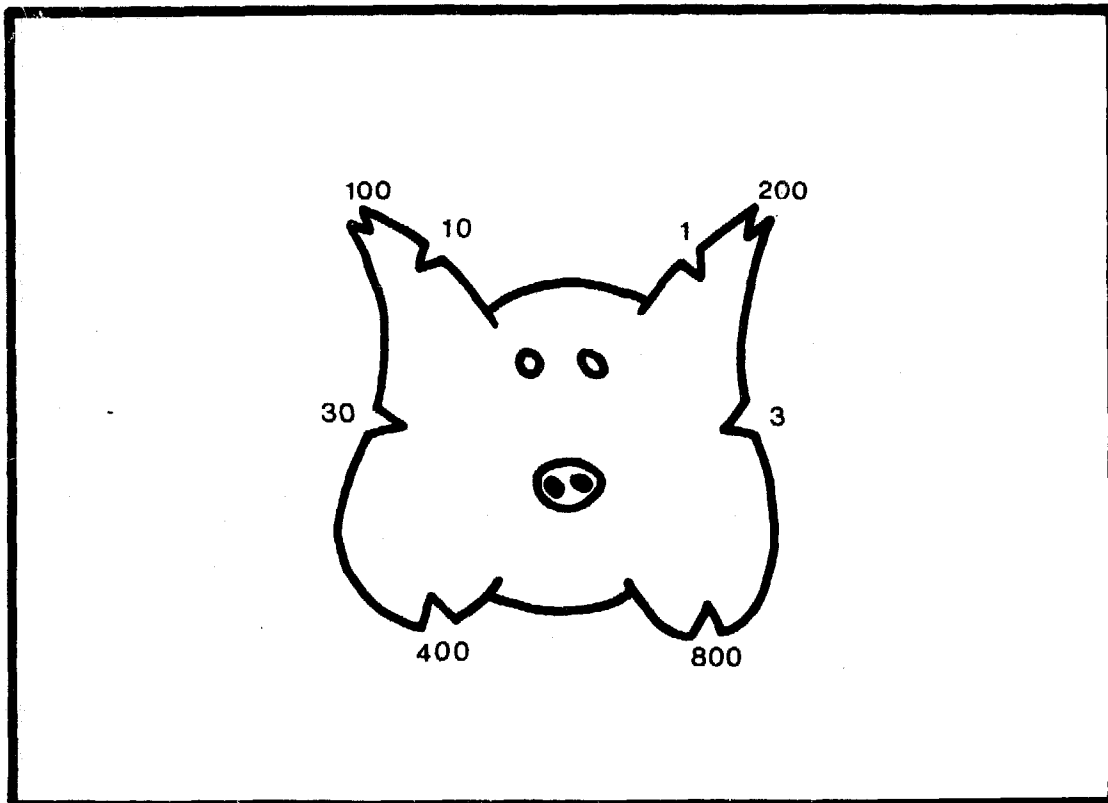

Diagram 11. The position and number of each notch used in the earnotching system

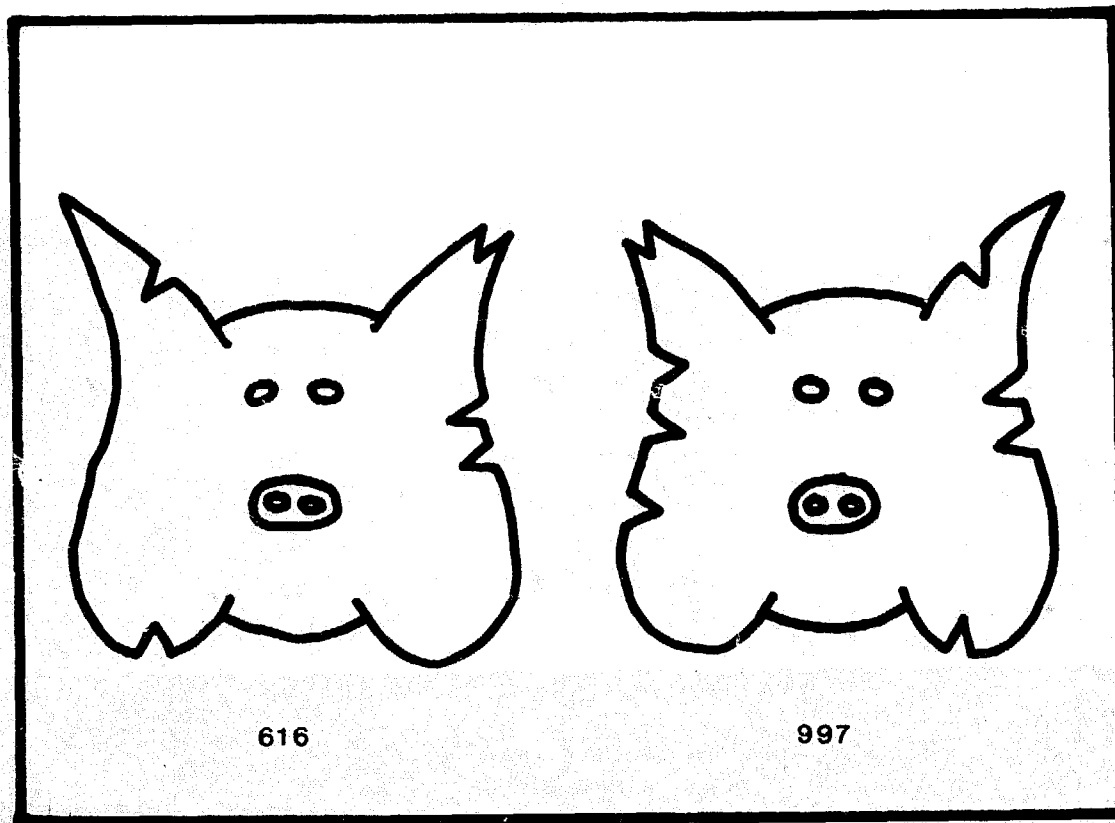

Diagram 12. Two examples of earnotched numbers

When the piglet is born it usually has up to 30 cms. of umbilical cord trailing from its navel. After a period of time the cord dries up and falls off, but until this happens it is dragged through bedding, faeces and urine as well as being trodden on by the owner or other pigs. It is therefore not unusual to see piglets suffering from navel infection as a result of the excess length of umbilical cord. A few minutes spent with each piglet as it is born can overcome any possible infection of the navel. A piece of cotton thread is tightly tied around the cord about 2 cms from the body. The cord is cut with a knife or pair of scissors a further 2 cms from the cotton. The 4 cms of cord left attached to the body is then dipped into an iodine solution to sterilize it. The iodine can be kept in a wide-mouthed jar so the umbilical cord can be dipped into it thus giving better coverage. If this operation is practised, navel infections will be rare.

Piglets are born with eight, very sharp "milk" or "eye" teeth which can cause irritation and serious damage to the sow. Cutting and even complete removal of the sow's teats can result from failure to remove these teeth at birth. Sometimes piglets can get infected mouths through these teeth cutting the insides of the cheeks, which then become infected.

All that is required for this operation is a pair of electrician's side-cutter pliers. The pliers are laid on the gum and the teeth cut off at gum level. Care must be taken not to cut the gums, tongue or other parts of the mouth and the teeth must not be pulled from the gum.

Both these operations should be done in the first day of life if maximum effectiveness is to be achieved.

3 Iron Supplementation

Piglets are born with enough iron in their bodies for approximately five days after which they suffer a deficiency until some form of iron is made available. Iron is necessary for correct functioning of blood and is essential for haemoglobin formation. Without an adequate level of iron the blood cannot transport enough oxygen around the body so the pig becomes tired, pale and suffers from ill-health. As piglets do not usually start eating solid foods until they are 10-14 days of age, it is important that they get some form of iron supplement before their bodies begin suffering a deficiency. As sow's milk is very low in iron it becomes very important to protect the health of the piglets.

There are several ways iron can be given to piglets.

Paste

Pastes are available which are placed on the piglet's tongue several times. The piglet swallows the paste and so gets its iron. This method is

not 100 per cent foolproof as the occasional piglet will spit the paste out and so will eventually suffer a deficiency.

Injectable iron

Injectable iron is widely used throughout the world as a sure method of iron supplementation. A quantity of iron (usually 2 mls.) is injected into either the hind leg or neck of the pig at two days of age through a syringe and short needle. The advantage of this method is that the farmer knows the pigs have got their iron and he therefore has no further worries. The disadvantage is that abscesses sometimes occur at the site where the injection was given even when sterile equipment is used.

Inexperienced operators can injure a piglet by hitting a bone with the needle or causing some other injury.

Hygiene must be of a high standard at all times when using injections.

Oral iron

There is now an oral form of iron which is given to the piglet within the first 18 hours of life by placing a length of plastic in the piglet's mouth and pressing a plunger fitted to the bottle holding the iron solution. The makers claim it is a very safe and effective way of giving iron which requires no special equipment or skill.

Earth

Probably the simplest and most common means of providing iron is to place a shovelful of clean red earth in the pen each day until the piglets start eating solid foods. By nosing through the dirt the piglets pick up enough iron to meet their body needs. The soil should be from an area known to have been free from grazing pigs as there is a chance that internal parasite eggs could be in the soil.

It is not important which method of supplementing the body iron is used as long as a method is used. It would be a very foolish farmer who did not make an effort to provide his piglets with additional iron.

4 Castration

There are two main reasons for castrating male pigs. One is because the boar meat has a peculiar taint or odour once the boar reaches sexual maturity and starts to serve sows. The other is because it lowers the urge to fight in a group of male pigs. These two main reasons are good enough and important enough to use castration, but against these reasons is the fact that entire males grow faster and more economically than either castrates (barrows) or females.

Castration itself is a simple operation requiring no special skills except cleanliness and hygiene, but there are several points which must be remembered:

- * Thoroughly clean the operation area with antiseptic.
- * Firmly hold the pig to avoid accidental injury to either the pig or the operator.
- * Use only sharp knives.
- * Make bold and decisive cuts — the quicker the operation is over the better.
- * Make the cut well down on the scrotum to allow for good drainage of the wound which will in turn lead to faster healing.
- * Do not cut the red cord attached to the teste as it is a blood vessel — scrape it until it severs.
- * Apply a coat of E.Q. smear to the wound after the operation to prevent screw worm strike.
- * Do not stitch the wound.

An operation such as this will affect the growth of the piglet so it is best done while the piglet is still suckling the sow. This will help overcome the stress resulting from the loss of its testicles. It is generally easier to castrate young pigs as they are easier to handle and hold.

5 Records

In all businesses the owner should know where his profit comes from and where he is having a loss. Pig farmers can only know this when they keep adequate records and adequate records means extra work. A simple recording system should show sow number, boar number, date of farrowing, number born alive, number born dead, number weaned and weight at weaning. Other things which can be recorded are who the pig is sold to and for how much.

Records can show which sow or boar is not producing enough piglets, which sow is producing the most profitable piglets, where improved management could result in greater profit and many other things. Records are essential if advisory help is used as they provide a true and accurate history of the business.

A few minutes a day can save a farmer many dollars worth of mistakes and, as he is farming for dollars, these few minutes are minutes well spent.

6 Mixing Pigs

Occasionally the situation arises where different pigs are penned together for some reason or other. Usually it is better not to mix pigs, but sometimes this is not possible. When pigs are mixed they always fight in order to settle their social standing and to establish the “boss of the pen”.

While they are fighting they are using up energy the farmer is feeding them at a certain cost, they are upsetting other pigs and they sometimes cause injury. All of these things cost the farmer money.

When pigs are mixed together they should be penned so there is not any room to move around in for several hours. This means that there is no room to fight and after sometime, they all smell the same and the desire to fight is lost. Penning such as this can be practised with smaller pigs, but adult pigs are a different matter. Careful attention should be paid to penned adults as they can cause serious injury to each other if they fight. If two adults do not settle down after a few minutes, they must be separated before one, or both, of them is hurt. It is a good idea for the farmer to keep a record of the pigs which are used to living together which he can refer to when he is mixing his pigs.

7 Loading Facilities

It does not take much effort to have a loading ramp constructed at the end of the piggery. A ramp needs to be strong and of the right height, but a few hours' work doing the job properly will save hours of hard work and bad temper.

8 Inspection Crate

There is nothing worse than having to treat a sow in a large pen with no means of keeping her still. A crate can be made from timber or steel pipe and can be movable or fixed in a certain spot. The crate needs to be strong and secure and reasonably open so any treatment can be given without too much inconvenience to the farmer.

The same crate can be used for scrubbing down sows ready to farrow or for pigs being taken to market. If it is a portable crate it can also be used for trucking live pigs from one piggery to another.

9 Stress

Any animal which is not content is suffering from stress and stress costs every commercial producer money. Pigs must not be unduly frightened by either humans, dogs or other pigs. A frightened or unhappy pig does not grow as fast or as profitably as a contented one.

When pigs are being moved from pen to pen they should not be hit or prodded with sticks, bars or boots. They should be moved quietly and slowly so as to avoid unnecessary stress.

A good farmer will handle his stock daily and his stock will know and trust him. This farmer will be more successful than his short-tempered counterpart.

Heat stress is quite often a problem in tropical countries. Pigs suffer from high temperatures and are easily sunburnt. Care must be taken

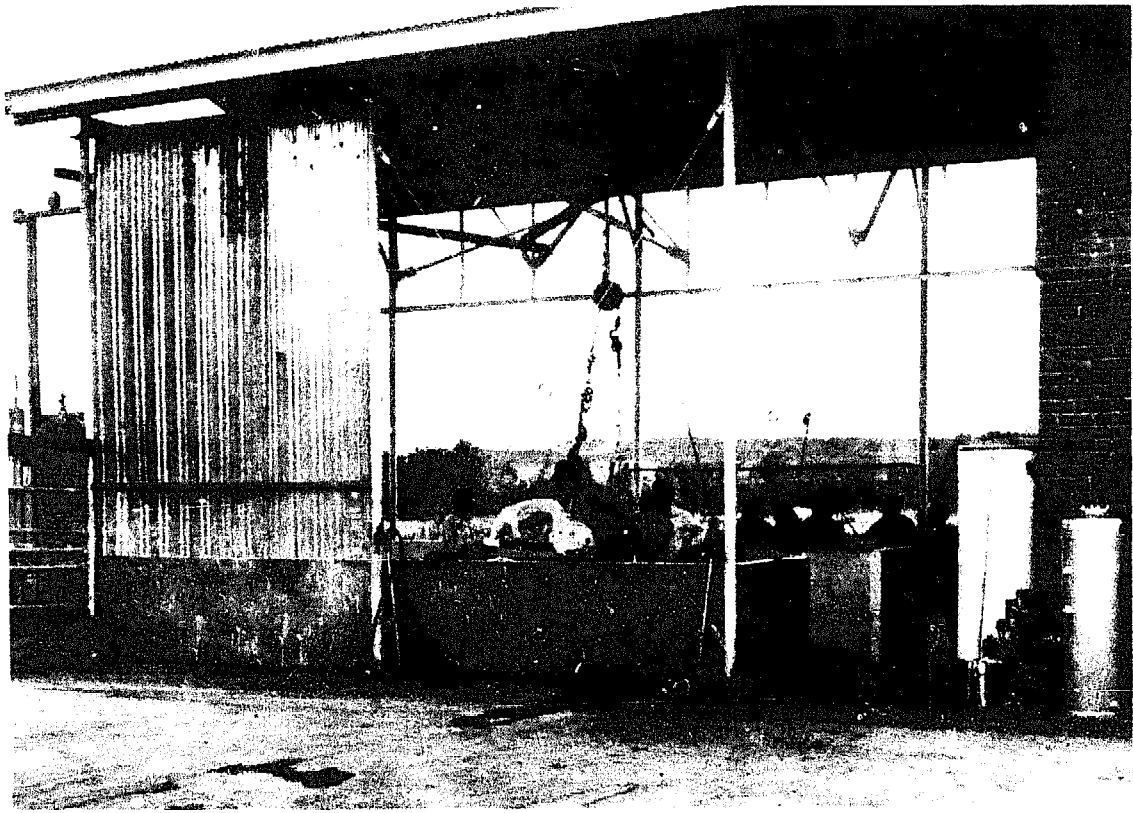

Plate 21. A modern slaughterhouse. If pigs are to be sold as meat in towns they must be killed in hygienic places such as this.

to avoid situations where pigs are left without shade, water or ventilation for any lengthy period. A pig suffering from heat stress must be shaded and cooled with water, which may mean that a temporary shelter is constructed over the pig and a mud wallow is made for it to lie in. Heat stress often occurs when pigs are being moved in an open truck during the hot part of the day so this should be avoided wherever possible.

The washing of pens should be done in the hot part of the day as this supplies some relief for the pigs.

10 Tailbiting

Tailbiting is common on all intensive piggeries. There are several theories why pigs start tailbiting, but no one seems to know for sure.

When tailbiting starts, the farmer must try to find out which pig is doing it. If he can catch the culprit before he has done much damage, the problem may not become severe. The pig doing the tailbiting should be removed from the pen and not returned until all the wounds have healed.

Some farmers hang chains from the roof or throw some empty bags or litter on the floor so the pigs have something to play with rather than bite tails when they become bored.



Plate 22. If meat is sold in butcher shops it must be displayed in an attractive way so the buyer is encouraged to buy it.

If tailbiting becomes a serious problem it may be a good idea to dock the tails of all weaners by cutting the tail off at the second joint from the base. This will leave a stub, but will also remove a very useful 'handle' for moving pigs.

7 PIG DISEASES

Every farmer must keep a close watch on his stock for any disease which may infect his herd. Not only does disease affect the health of the pig, it also affects the profits from the piggery because diseased pigs do not grow quickly and economically. It is nearly always better to spend some money in removing the disease problem rather than let it stay in the herd.

There are many different diseases which affect pigs but only a few will be discussed here. For further information on pig diseases farmers should ask their local livestock expert or agricultural worker.

It is intended that the diseases mentioned in this chapter shall be discussed in terms of symptoms and economic importance. The treatment of any disease is best left to the experts who are trained for this work.

Parasites

There are two kinds of parasites which affect pigs — internal and external or inside and outside. The internal parasites are worms while the external parasites are lice and mange mite.

A parasite is something which feeds on a host but does not benefit its host in any way at all. Parasites take away food which would otherwise be used by the host for growth and generally weaken the animal which leads to lowered resistance to further disease attack.

1 Internal parasites

Large Roundworm (Ascaris suis)

This worm probably causes more trouble to pig farmers than any other.

They may be up to 25 cms. long as adults and are usually found in the small intestine but may also be found in the stomach and liver.

Life cycle

The female worm can lay as many as 200,000 eggs a day which pass out in the faeces. Under ideal conditions these eggs may become infective in four to eight weeks but may take several months under colder conditions.

By eating infected worm eggs from pasture or contaminated quarters, the pig allows the eggs to hatch in the intestines. The larvae leave the intestines and travel to the lungs via the liver. When they reach the lungs they are coughed up and swallowed so they are once again in the intestine. They stay here and grow to maturity and so the cycle starts again.

Symptoms

Infection causes most damage to pigs between three and four months of age which is also the period of fastest growth.

The pigs fail to grow or are very slow growers, are stunted and usually cough a lot. Other symptoms are diarrhoea, straining to pass faeces and they can be pot-bellied. Slow growth is usually the first symptom a farmer notices but this usually takes several weeks before it becomes obvious.

Prevention

The easiest way to prevent roundworm infestations is by proper management.

- * Clean all pens thoroughly between batches of pigs. Farrowing pens should be cleaned very thoroughly.
- * Wash sows before they are put in the farrowing pen. Make sure that there is no mud on the sow as dirt usually contains worm eggs.
- * Before washing the sow, she should be dosed with a pig wormer two weeks before she is due to farrow. This will make sure that there is less chance of the piglets becoming infected from the sow droppings.
- * If pigs are being grazed then a regular and fairly long rotation is essential if the level of infection is to be kept as low as possible. In tropical areas, which have ideal conditions for internal parasites, the land must be spelled between pigs for at least four to six months.

By using good management the level of infestation will usually be fairly low. Poor hygiene and management will result in severe worm problems.

2 External parasites

Sarcoptic Mange

Sarcoptic Mange is fairly common in pigs of all ages.

The mite can just be seen by the naked eye when it is crawling against a black background.

Life cycle

The mites are very small, about 5 mm in length and are a yellowish colour. They burrow into the skin and dig burrows into which the eggs are laid. A female mite lays between 10 and 15 eggs over about 12 to 15 days and then she dies in her burrow. The eggs take about three to

ten days to hatch and after several moults they reach maturity and begin to lay eggs about 10 to 12 days later. This means that the life cycle of the mite takes about fifteen days so it can be seen that a small infestation can soon become large scale.

Symptoms

The burrowing causes intense itching to the pig which tries to ease the irritation by scratching or rubbing.

Mange usually starts near the head, around the eyes and nose. The pig rubs against a post or scratches itself with its hind feet, so the second area of infection is usually the neck and shoulders, then the back and sides and finally the whole body. A good pig farmer will treat the pig long before it reaches this stage.

By constantly rubbing and scratching the itchy areas the skin becomes hairless, dry and scurfy. Large, grey coloured scabs usually form over areas rubbed raw.

Mange causes loss of growth through constant irritation and provides areas for other infection through rubbing raw patches on the skin. By far the most important loss is economic.

Prevention

Mange is spread by contact so management is an important factor in control. It is usually introduced to a piggery by a pig brought into the herd. All new pigs brought into a piggery should be treated for mange in an isolated pen away from the rest of the pigs for at least two life cycles (i.e. thirty days) while undergoing two spray treatments. By doing this the chances of getting mange are reduced.

Mange cannot reproduce itself except on the bodies of animals but it can live for a short time — up to several weeks — on its own. In dry and bright places the mites and eggs can live for only several days, so it is worth while keeping the pens dry at all times. Healthy and well-fed pigs are not likely to get mange as easily as stunted and unhealthy pigs.

Roundworms and mange are probably the two main parasites affecting pigs. Others exist and are economically important.

Respiratory Diseases

Probably the most important respiratory disease is pneumonia.

In tropical areas pneumonia usually results from migrating internal parasites (round worms) or a lungworm infection.

The symptoms of pneumonia are coughing usually associated with short and sharp breathing. Because this causes a reduction in the amount of oxygen inhaled into the lungs, and therefore available for

the body to use, pneumonia causes stunted and reduced growth and a general lowering of disease resistance by the pig. Severe cases lead to death.

The provision of dry, warm and draught free housing, well drained yards and good feeding are important management practices necessary to prevent this disease.

Where pneumonia is assisted by internal parasite infection, a worming programme must be introduced.

Digestive Disorders

Scours is probably the most important digestive disorder in young pigs. Scouring is generally restricted to pigs under 16 weeks of age, but should it occur in older pigs it is usually a sign of a much more serious disease.

Piglets scour very easily and as scours affect health and growth it is important that they be treated as soon as possible.

In very young piglets scours can be the result of very strong sow's milk which is caused by the sow being fed incorrectly or not being supplied with enough water. Attention to diet and water can usually overcome this problem.

If scours persist then anaemia (iron deficiency) could be the reason. A dose of iron supplement will sometimes clear it up or a spadeful of clean red earth also helps.

Scours sometimes result from too rapid changeover of feed at weaning. This can be overcome by introducing the new feed over a five to ten day period.

Because scours can lead to sudden death through dehydration, prompt treatment must be given. Not all scours are caused by those things mentioned above.

Bacterial scours are highly infectious and can cause sudden death of many piglets. It is therefore a good idea to see a livestock expert as soon as any scours appear. It is better to be safe than sorry.

Infectious Diseases

Anthrax

An important infectious disease in many countries is anthrax. In Papua New Guinea it is fairly common disease in the village pig population with outbreaks occurring periodically.

Anthrax is caused by a bacteria called *Bacillus anthracis*. Pigs in poor condition, poor health and living in cold damp conditions seem to be more likely to become infected than well fed pigs living in good conditions.

Symptoms

The most common symptom is swelling of the throat, hot skin and general tiredness. It is quite often first suspected after one or two pigs die suddenly for no real apparent reason. Sometimes blood stained froth can be seen around the mouth.

Because of the swelling of the neck breathing becomes difficult and short.

Treatment

Any suspected anthrax cases must be reported to the nearest agricultural office as soon as is possible. It is a very dangerous disease to both man and animals and it is important to stop its spread before it becomes serious.

Pigs can be vaccinated against anthrax and in Papua New Guinea the Department of Agriculture, Stock and Fisheries vaccinates all pigs free of charge.

Infected pigs can sometimes be treated with large doses of penicillin, but this must be done by an experienced livestock expert.

Summary

The treatment of diseased animals should be done under the supervision and advice of a livestock expert. The animal is too important for inexperienced farmers to try to treat — always seek advice and never be afraid or embarrassed to ask for help because that is why veterinary and livestock officers are employed.

8 Poultry Production

There are various forms of poultry management in the South Pacific each very different from the other, and each dependent on the reason why the farmer is keeping poultry. The three forms can be defined as: village poultry keeping, the semi-commercial poultry farmer and the poultry farmer-businessman or commercial farmer.

1 Village Poultry Keeping

In this system the birds are allowed to run all over the village. They are sometimes fed bought feed, but usually scavenge for themselves and they hatch their own eggs. In other words, the birds are just "there" and the owner takes the eggs and meat for his table whenever he wants and whenever they are available. In this system production is usually very low, mortality rates are very high and it is a very inefficient method of keeping poultry. However, the advantages are that the owner does not have to spend any time or money on the birds and can devote his time to other things that may be more important to him. Therefore, any methods that are introduced to improve the efficiency of this type of poultry keeping must be carefully studied against the owner's desires and the availability of time and money.

2 Semi-Commercial Poultry Farmer

This system is the next stage up from No. 1, where the farmer either grows some special feed for his birds or buys feed, and he will probably have bought some of his birds which will be better than village poultry in that they have the capacity to produce more eggs or meat. With this system the farmer is trying to provide for himself more eggs and meat and to be able to sell any surplus which would help to pay for bought feed and the cost of the bought chickens. This system of poultry keeping is being used more and more in the South Pacific today to provide protein for the farmer's family.

3 Commercial Poultry Keeping

This is the keeping of poultry for business purposes. Little or none of the produce (eggs or meat) is kept by the farmer as he sells all of his produce. This system of poultry keeping has nearly always failed in the South Pacific as the farmer does not have the knowledge or management ability to make a profit, so, in the past, most of the commercial poultry projects have failed.

9 Semi-Commercial Poultry Keeping

A semi-commercial system can achieve an increase in production over that obtained from traditional farming provided that some form of housing and some form of supplementary feeding is available. Basically this form of poultry keeping requires the birds to be kept in a house where they are given their supplementary feed and where they will lay their eggs. At mid-day they are let out to scavenge as they would in the village system.

1 Housing

The size of the house need only be small, about .25 sq. metres per bird, and should be made out of bush materials. For 10 hens and one rooster the house would be 1.5 metres x 1.5 metres, have three nests, some roosting space and a feed and water trough made out of large bamboo. The following is a plan of a suitable house for this system of production:

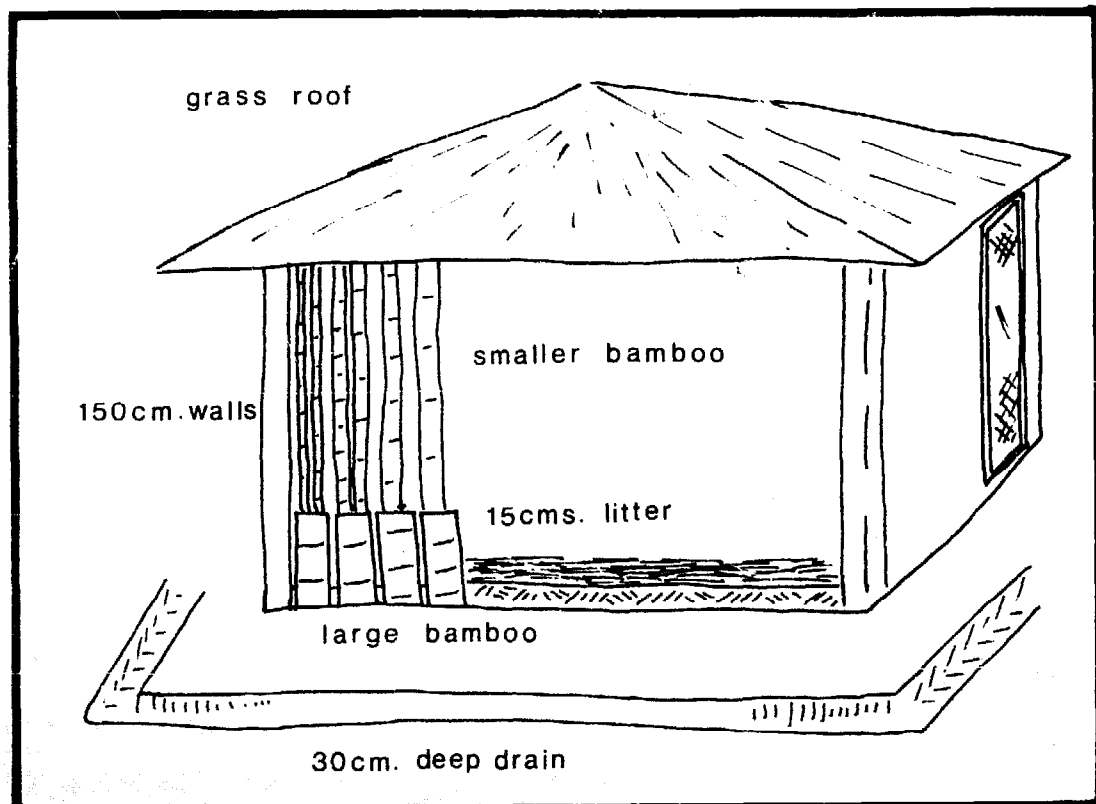

Diagram 13. Plan of a house suitable for semi-commercial poultry keeping.

It is important to have plenty of overhang on the roof and a deep drain around the building to stop water getting in. The floor should be covered in a suitable deep litter material such as coffee skins, rice husks, chopped up dry grass, sawdust, or shavings to a depth of 15 cm.

2 Feeding

For this type of management it is essential that a high protein feed be fed to the birds. When the birds are out scavenging in the afternoon they will find themselves plenty of feed, but most of it will be of a carbohydrate nature which is low in protein and unless they are fed a high protein supplement their production will be low. The farmer must therefore either buy a high protein feed, such as protein concentrate or meat-meal, or grow a high protein feed such as soybeans for his birds. Buying the feed is easier, but protein concentrate cost is high. The farmer himself must decide whether he has the time to grow the soybeans, or has the money to buy the feed. The soybeans or bought feed should be mixed with cooked kau kau, taro or yams, or better still, with grain, (sorghum or corn) in equal proportions so that each bird receives 56 gms of feed per day (i.e. 28 gms of high protein feed and 28 gms of other feed).

In this way, a bag of bought feed (50 kgms) would last eleven birds 5½ months. The sale of one egg per day from the project would more than cover the cost of the bought feed.

From this type of feeding the farmer could expect about three eggs per day from his ten hens.

If he wanted to increase his egg production and was prepared to grow some feed he must first work out how much feed he would have to grow. An adult bird will eat 110 gms of feed per day, and even though the birds will be outside scavenging for 4-5 hours per day it is wise to provide this amount of feed. At 110 gms of feed per day the eleven birds will eat 1.25 kgms feed per day; or 8.75 kgms per week; or 455 kgms per year.

Below are some suitable mixed rations for this system, provided the birds run outside for 4-5 hours every day.

Crushed grain	64	Crushed grain	79
Dried greenfeed	5	Dried greenfeed	10
Peanuts	21	Concentrate	11
Concentrate	10		
	100 kgms		100 kms
Crushed grain	60	Crushed grain	70
Crushed peanuts	40	Crushed soybean	30
	100 kgms		100 kgms

Table 6. Rations suitable for semi-commercial poultry keeping.

Soybeans and peanuts must be cooked for twenty minutes and then dried before being mixed into the ration.

3 Management

Daily:

- 1 Feed and water the birds.
- 2 In the afternoon, clean both the feed and water troughs.
- 3 Collect the eggs.
- 4 Let the birds out at 12 o'clock.
- 5 Lock the birds up at night.

Twice a week:

- 1 Rake over the deep litter and replace any wet litter.
- 2 Clean out nests and put in fresh nesting material.

Yearly:

- 1 Thoroughly clean out the house.
- 2 Take out the deep litter and use on vegetable garden.
- 3 Put in fresh litter.
- 4 Sell off the old birds and replace with young birds that have been either bought or reared in the village. It is best to cull (sell or dispose of) the laying stock at 18 months of age, i.e. after they have been laying eggs for 12 months. If birds are kept longer than 18 months, it will cost more to feed them than the money the owner receives from the sale of eggs. As the owner is in business and relying on a cash income, he must time the replacement of his laying stock so that they will start laying eggs at the time that his layers have reached 18 months.
To be ready at the right time, the replacement stock must be bought as day old chickens when the laying stock are 12 months of age.
- 5 Make any necessary repairs to the house.

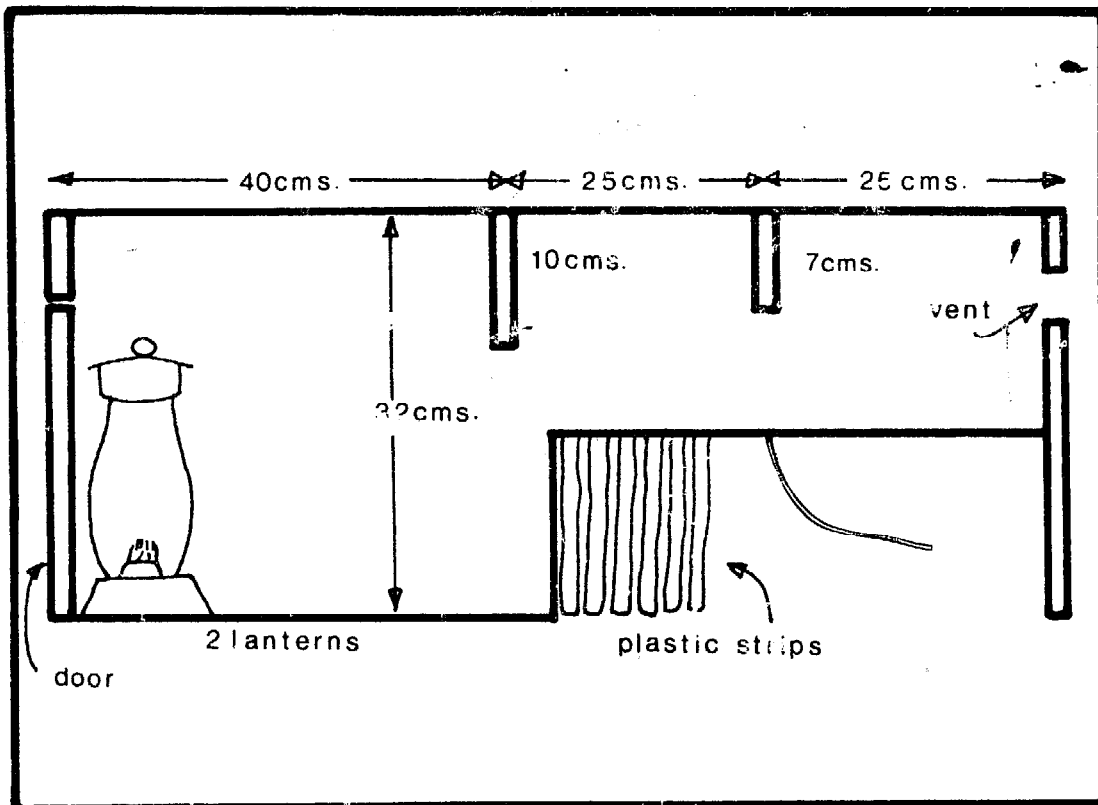

Diagram 16. A kerosene brooder for highland areas.

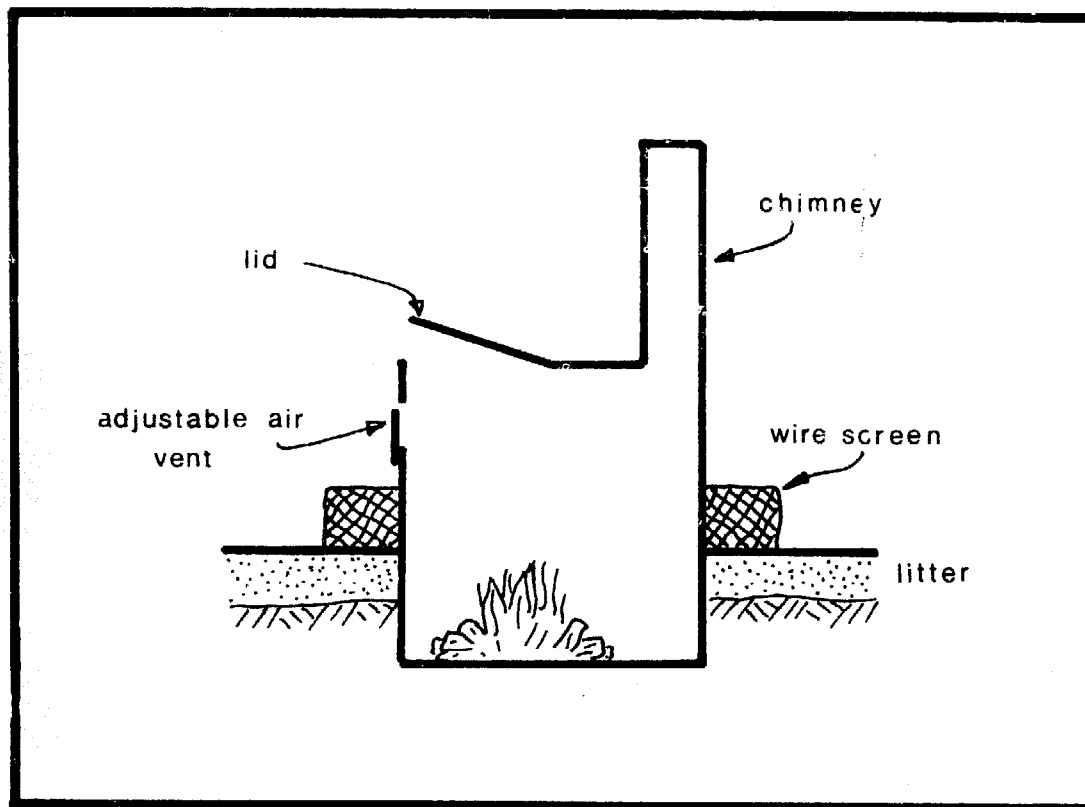

Diagram 17. A warm earth brooder.

placed in a 'surround' where there are no corners for them to huddle and smother.

A 2-metre surround is suitable for 250-300 chickens. The idea is to

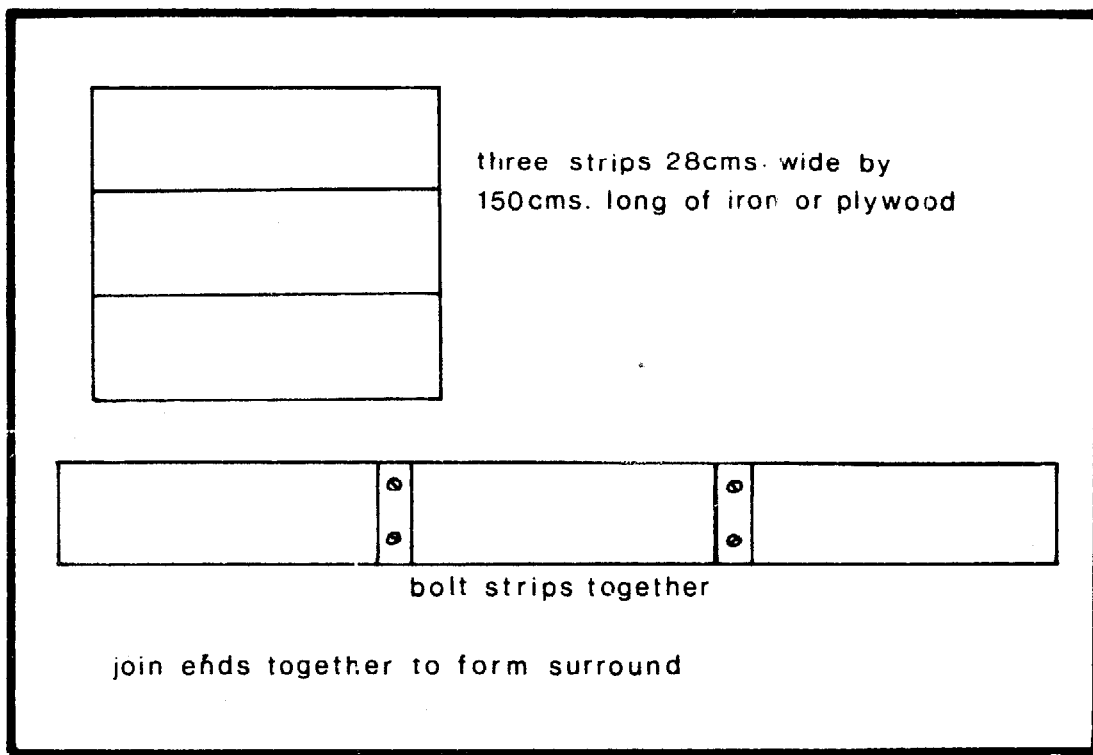

Diagram 18. A chicken surround.

keep the chickens confined for the first two weeks close to their source of heat, feed and water. After this period the area can be gradually increased until at four weeks of age they are using the whole floor area of 100 sq. cms per chicken. The surround can be taken away after two weeks, but the corners of the house should be blocked off to prevent crowding.



Plate 27. A typical commercial broiler house at Lae, Papua New Guinea.

12 Feeding Young Chickens

Day old chickens require a 20-21% protein feed. Regardless of whether the chickens are for meat or egg production, they require this feed. The feed must be medicated, that is, it must have a Coccidiostat to prevent the disease known as 'Coccidiosis'.

When buying feed, the farmer must look at the label on the bag to see whether or not the feed is medicated. If the label says that it is medicated, this means that a Coccidiostat has been included in the chicken feed.

The chickens are fed the 21% protein medicated feed for the first six weeks of their life. If the farmer is raising meat birds then he must keep feeding this feed until the birds are 9-10 weeks of age when they will be sold at the local market. If the farmer is raising pullets for egg production, at the end of six weeks he changes his feed to what is called a grower feed. This feed is much lower in protein and it should be around 15% protein. The main reason that pullets are fed a lower protein feed is:

- * to save on the cost of raising the pullet
- * to delay the maturity of the bird when it starts to work, that is, when it starts to lay eggs.

By delaying maturity, the bird will produce larger eggs when it starts to lay. If a bird is made to lay eggs at too young an age, most of the eggs it will produce during its life will be small eggs. The price received from small eggs is not as much as that received for large eggs. Therefore, the more large eggs a farmer produces, the greater his profit will be.

Lowering the protein content of the feed from 21% to 15% for the actual growing period of the bird is probably the easiest way of delaying maturity. So for the first six weeks a layer chicken is fed a 20-21% protein medicated feed, but at the end of six weeks it is changed over to a grower feed which is also medicated, until the bird is about 24 weeks of age when it begins to lay.

The two most important things in the life of a chicken are water and feed. It must be fed good quality feed and it must receive clean water daily. A chicken does not like stale water or poor feed.

A chicken will not grow properly and in later life be a good egg-laying bird if it is not fed properly. Feeding is the most important part of poultry management.

If a farmer wishes to be a commercial poultry keeper, it is usually necessary for him to buy his feed because he will not have enough time to go out into the field and grow his own corn and soybean and all the other things that are necessary for a good balanced ration.

13 Management and Feeding of Laying Hens

The laying hen requires a protein food of 16% — and to achieve high production it must be a well-balanced ration. Again, the farmer can either buy his feed or he can grow his own. If he buys his feed, he must buy a layer ration. If he wishes to grow his own feed, the following are some of the different mixes he can use:

1 Grain (rice, corn or sorghum) mixed with poultry concentrate

	<i>Starter and Broiler Ration (20%)</i>	<i>Grower (15%)</i>	<i>Layer (16%)</i>
Grain	70 kgms	80 kgms	71 kgms
Poultry Concentrate	30 kgms	20 kgms	29 kgms
Total feed	100 kgms	100 kgms	100 kgms

Table 7. Rations compiled from imported concentrate and locally produced grains.

All the minerals, vitamins, proteins and carbohydrates are balanced when poultry concentrate is used, but it costs more than if most of the feeds are home grown.

2 Using soybeans and grain both of which could be home-grown

	<i>Starter and Broiler Ration</i>	<i>Grower</i>	<i>Layer</i>
Soybeans	30 kgms	10 kgms	20 kgms
Meatmeal	10 kgms	10 kgms	9 kgms
Grain	60 kgms	80 kgms	71 kgms
Vitamin Supplement	40 gms	40 gms	40 gms
Salt	225 gms	225 gms	225 gms

Table 8. Rations compiled from locally produced feedstuffs.

The cost of the vitamin supplement is very small, almost negligible.

3 Another way of feeding poultry is for the farmer to grow his own sweet potato and mix this with poultry concentrate

The farmer must use poultry concentrate because sweet potato is very low in protein and the birds will not grow or lay eggs if fed sweet potato alone.

The requirements for one bird for the various ages are shown in the following table:

<i>Age of Bird</i>	<i>Concentrate (kgms)</i>	<i>Sweet Potato (kgms)</i>	<i>Total (kgms)</i>
0-6 weeks (+ broiler ration)	0.30	1.50	1.80
6-26 weeks	1.90	17.10	19.00
6-18 months	8.60	77.50	86.10

Table 9. Concentrate: Sweet potato rations for various ages of poultry.

The figure in the concentrate and sweet potato column is the amount of feed each bird will eat for that period of its life.

Table 10 shows how much the farmer would have to give ten birds each day. The sweet potato is cooked and then mixed with the protein concentrate.

<i>Age of Bird</i>	<i>Concentrate</i>	<i>Sweet Potato</i>	<i>Total</i>
0-6 weeks (+ broiler ration)	70 gms	340 gms	410 gms
6-26 weeks	160 gms	1.43 kgms	1.59 kgms
26-78 weeks	2.30 gms	2.13 kgms	2.36 kgms

Table 10. Feed requirements for a 10 hen layer enterprise feeding concentrate and sweet potato

Feed Consumption Rates for Grain Rations

<i>Week after Hatching</i>	<i>100 Chickens will Eat</i>
1st week	4.50 kgms feed
2nd week	9.0 kgms feed
3rd week	13.5 kgms feed
4th week	18.0 kgms feed
<i>Total Feed Consumption</i>	
To 4th week	45.4 kgms feed
To 6th week	95.3 kgms feed
To 8th week	163.4 kgms feed
To 12th week	345.0 kgms feed
To 24th week	908.0 kgms feed

Table 11. Feed consumption rates for grain rations.

<i>Housing</i>	<i>Age in Weeks</i>			
	<i>0-4</i>	<i>4-10</i>	<i>10-20</i>	<i>Adult</i>
Floor space (sq. metre/bird)	0.05	0.1	.25	.4
Feeding space (metres/100 birds)	1.8	3.0	4.26	6.0
Water space (metres/100 birds)	0.6	0.9	1.8	2.4
Roosts (metres/100 birds)	—	9.0	15.3	18.0

Table 12. Housing requirement for various ages of poultry

Layers can either be housed on deep litter or can be allowed to run outside. Provided they are being fed properly it is quite alright to keep them housed all the time on deep litter. If they are allowed to go outside they are quite often killed by dogs, or they can become infested with internal parasites such as worms, which will lower their production and affect their health.

On a commercial poultry farm, it is better to keep birds housed on a deep litter floor. Management of the layer is very easy if they are on deep litter as all that is required is that they be fed and watered daily. The feed and water troughs must be kept clean, the deep litter material should be raked over at least two or three times a week, and the eggs should be collected twice daily — at 11 o'clock in the morning and 3 o'clock in the afternoon. Also, any sick birds should be removed immediately from the house.

Nesting material is very important because the hen prefers a comfortable and relatively dark place with sawdust, coffee skins or soft grass in the nest to lay her eggs on. One nest for every 4-5 birds is necessary and the nest should be placed about 45 cms off the ground. A four-gallon kerosene tin with half of the top cut out makes a very good nest.

The laying bird is the bird that produces eggs which are sold for profit; so everything must be done which will keep the birds laying as well and as long as possible.

Roosters are only necessary if the farmer wants to breed chickens. If the birds are kept to sell their eggs, then the birds will lay more eggs if there is no rooster kept with them. Roosters are not necessary for birds to lay eggs. Fertilised eggs will only stay fresh for three days, but unfertilised eggs will stay fresh for at least a week as the eggs are not 'alive'.

Laying hens require 0.25 sq. metres of floor space if kept in a deep litter pen. They should be provided with roosts, egg nests and clean, fresh water. Green feed should be fed once a day. It is a good idea to have a separate box with coral or shell grit in it for the birds to peck; this provides plenty of calcium to make the egg shells strong. Hard grit or very small stones should also be provided in a separate box for the birds. Poultry do not have teeth and the hard grit is picked up by the bird and held in the gizzard which helps grind the feed. The birds are fed a 16% layer ration which is best fed in a self feeder once a week thereby making management easier.

As with chickens and growers, the deep litter material should be turned at least once a week.

Eggs should be collected twice a day at 11 a.m. and 3 p.m. By collecting eggs twice a day, there will be less broken eggs and there being less eggs in the nests, the birds are less likely to start eating their own eggs.

The nests must have clean grass or coffee hulls, etc., in them for the hens to lay their eggs on. This should be changed every 2-3 weeks.

Clucky or broody hens (that is, birds that sit on the eggs to hatch them) are best discouraged by placing them in a wire cage for three days.

Some Points for Good Layer Management

- * Give correct feed.
- * Fresh water available at all times.
- * Make green feed available once a day.
- * Make shell grit and hard grit available in separate boxes.
- * House must be water-proof and free of draughts.
- * Plenty of roosting space and nests are necessary.
- * Turn deep litter once a week (at least).
- * Nesting material must always be clean (to keep eggs clean).
- * Collect eggs twice a day.
- * Cull layers at 18 months of age.
- * Keep layer house a good distance from young stock shed.
- * Clean houses out thoroughly before putting in new stock and rest for three weeks.

Some Useful Facts

- * Roosters are **not** necessary for hens to lay eggs.
- * Hens will lay 160-240 eggs in twelve months.
- * Losses from day-old to 18 months should not be higher than 15-20% for the business to be economic.
- * Pullets will start laying at 24-26 weeks of age.
- * As a rough guide for budgeting for layers, the sale price of ten eggs should be ten times the price of 0.5 kgms of layer feed; e.g. 0.5 kgms of feed costs six cents, therefore the sale price of ten eggs should be 60 cents.

10 Commercial Poultry Raising — Meat Production

For commercial poultry farming, commercial poultry breeds must be used. Because of the high cost of food it is essential to get as many eggs as possible from the birds, therefore good quality stock must be used. In Papua New Guinea there is only one commercial hatchery — Ilimo Farm Products at Port Moresby — which sells “Hyline” chickens. These birds are a hybrid (which means that they are produced by cross-breeding of different breeds) and consequently they can only be used commercially, that is, to produce meat or eggs. The eggs or birds must not be used for hatching or breeding. This means that the farmer must keep replacing his stock as his existing stock become old. Throughout the world, hybrid stock are now used almost exclusively for commercial poultry farming as their production is so much higher than the ordinary pure breed such as the White Leghorn or Australorp. If a farmer wants to be a commercial poultry farmer, it is recommended that he purchase his chickens from Ilimo Farm or from a good hatchery in Australia.



Plate 23. Nine weeks old meat birds ready for market.



Plate 23a. A good laying hen.

Poultry Meat Production (Broiler Production)

There are two poultry processing works in Papua New Guinea. One is at Port Moresby and one is at Lae. Most poultry meat production will be for the 'live' market and will be sold through the village market. Meat birds reach a marketable weight at 9-10 weeks and to increase profitability, all the birds should be sold at the one time.

It is therefore a good idea to only raise the number of chickens which can be sold at the one time, which would probably be about 25-30 chickens. If the birds are held longer than 10 weeks, it could cost more to feed them than the extra money received from their sale.

Housing

A chicken requires a floor area of .1 sq. metre. The house should be built of bush materials with plenty of roof over-hang and surrounded by a deep drain to keep out any water.

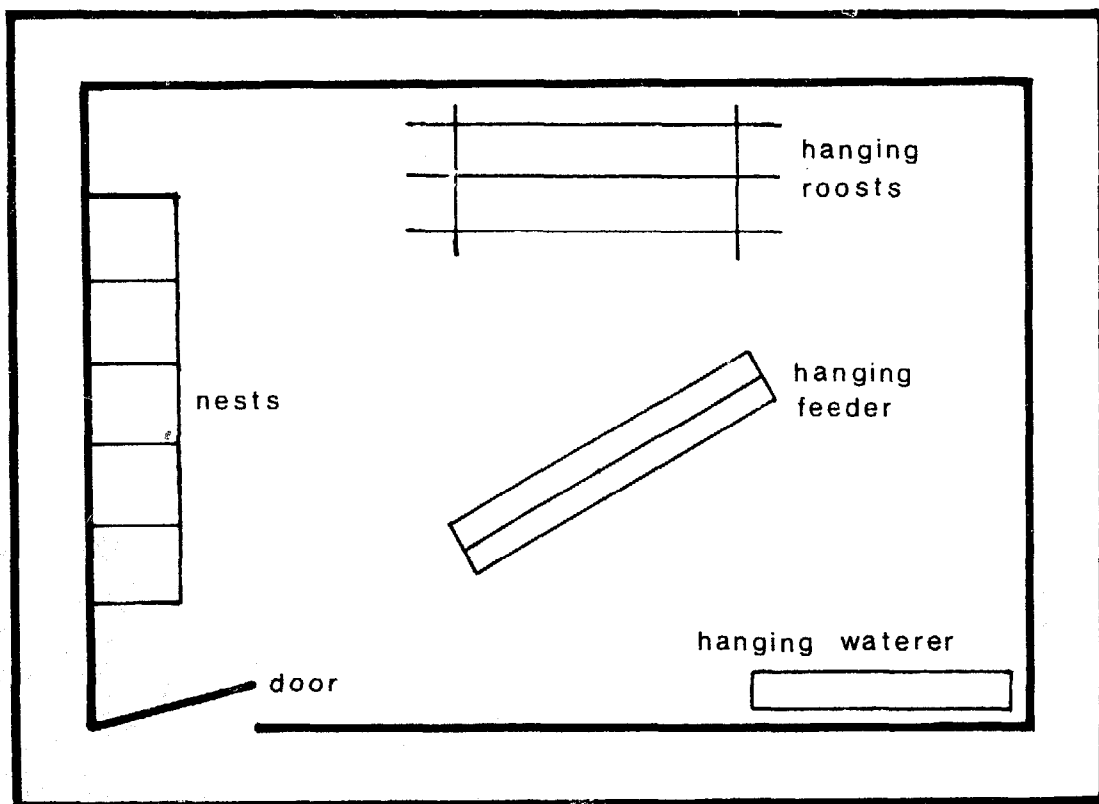

Diagram 14. Plan of a house suitable for egg production, note, only waterers and feeders are necessary for broilers.

The earth from the drain is thrown inside the house and compacted until it is very hard. This then raises the level of the floor to ensure that no water comes inside. The floor is then covered with 15 cms of a suitable deep litter material.

Feed and water troughs are placed in the house allowing 56 cms of feeding space per ten birds and 28 cms of watering trough per ten birds.



Plate 24. A feed trough suitable for young birds.



Plate 25. A feed trough suitable for Layers.

Bird Management

Only meat strain birds should be used for meat production as they have the capability of producing more meat for feed eaten. In Papua New Guinea these are available from Ilimo Farm. They are called 'Hyline' Meat Strain Birds and are bought unsexed. Both pullets and cockerels are raised for meat production.

The birds are bought as day old chickens and are raised for the first six weeks as described in Chapter 11.

The feeding of broilers differs from pullets in that they must be fed a high protein diet for the whole nine weeks it takes to raise them. They should be fed a 20-21% protein medicated feed which has to be bought and it is essential that feed and water be available to the chickens all the time. Their feed and water supply must never run out. The idea of raising meat birds is to have them grow as much meat as possible in as short a time as possible. Feed and water, if not constantly available, will slow down their growth rate which will mean less profit for the farmer. The chickens must be kept on this feed for the whole period and as soon as they reach 1600 grams liveweight they should be sold at the market. Some chickens will grow faster than others and may be able to be sold in the eighth week, but all chickens must be sold off the farm by the tenth week. The birds should be kept inside the house at all times. Grass can be fed to the birds daily. This often relieves boredom and the tendency to feather pick. If meat birds are allowed outside and to roam at will, feed intake will be used in excess exertion instead of meat production.

Daily Management

- 1 Fill feed and water troughs three times a day (or as necessary)
- 2 Clean water troughs daily.
- 3 Rake over deep litter daily.

After Each Batch of Chickens

- 1 Remove all deep litter and put on to a vegetable garden.
- 2 Thoroughly clean all feed and water troughs.
- 3 Spell (rest) the house for three weeks between batches of chickens.
- 4 Clean all dust, spiders webs etc., from the ceiling of the house.

11 Looking after Small Chickens

Chickens require a uniform temperature for the first six weeks of their life. In nature the warmth of the hen's body provides the chicken with sufficient heat, but when chickens are raised artificially a source of heat must be provided for them. In Papua New Guinea this is most economically provided by warm earth brooder or kerosene lamp.

Coastal Areas

The easiest method is by using a kerosene lamp and a sheet of 3-ply timber.

A hole is cut in the middle of a 112 cm x 112 cm piece of plywood for the lamp. The brooder should be 15-20 cms high from the floor. The lamp should be lit about 5 o'clock in the afternoon. Pieces of bag 5 cms wide are tacked onto the 3-ply (see photograph) to keep the heat in and allow the chickens to go in and out. This is a very easy brooder to make.

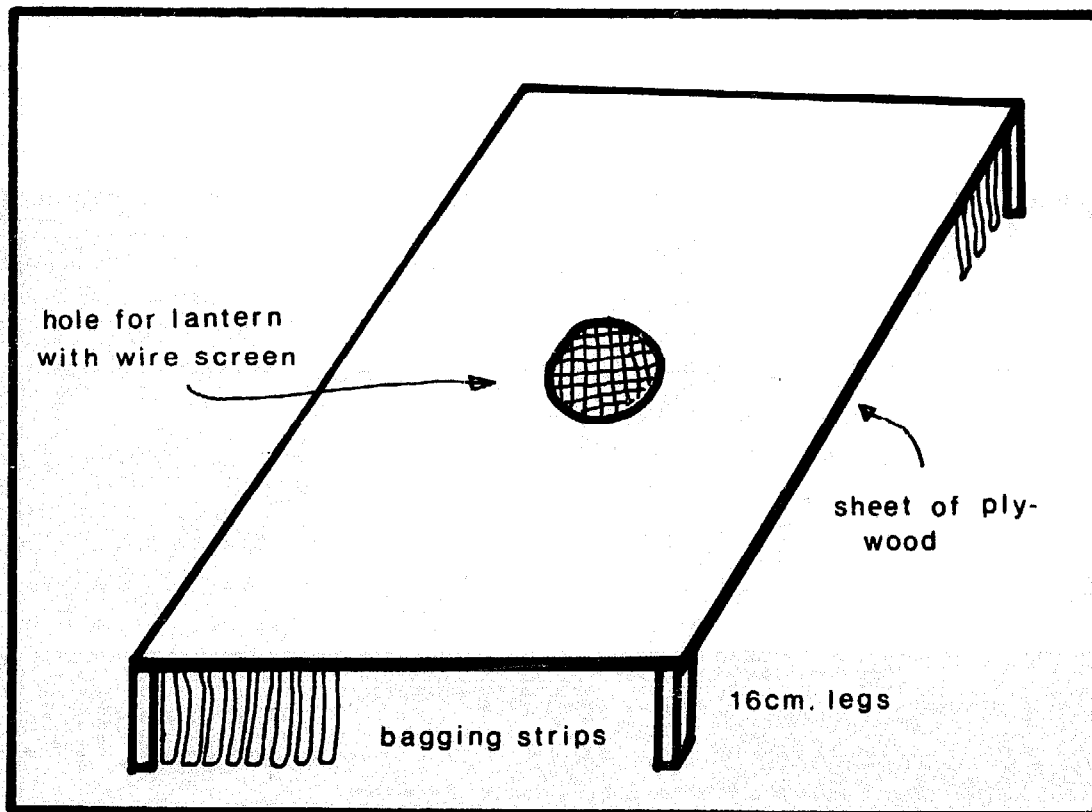

Diagram 15. A brooder suitable for coastal areas.

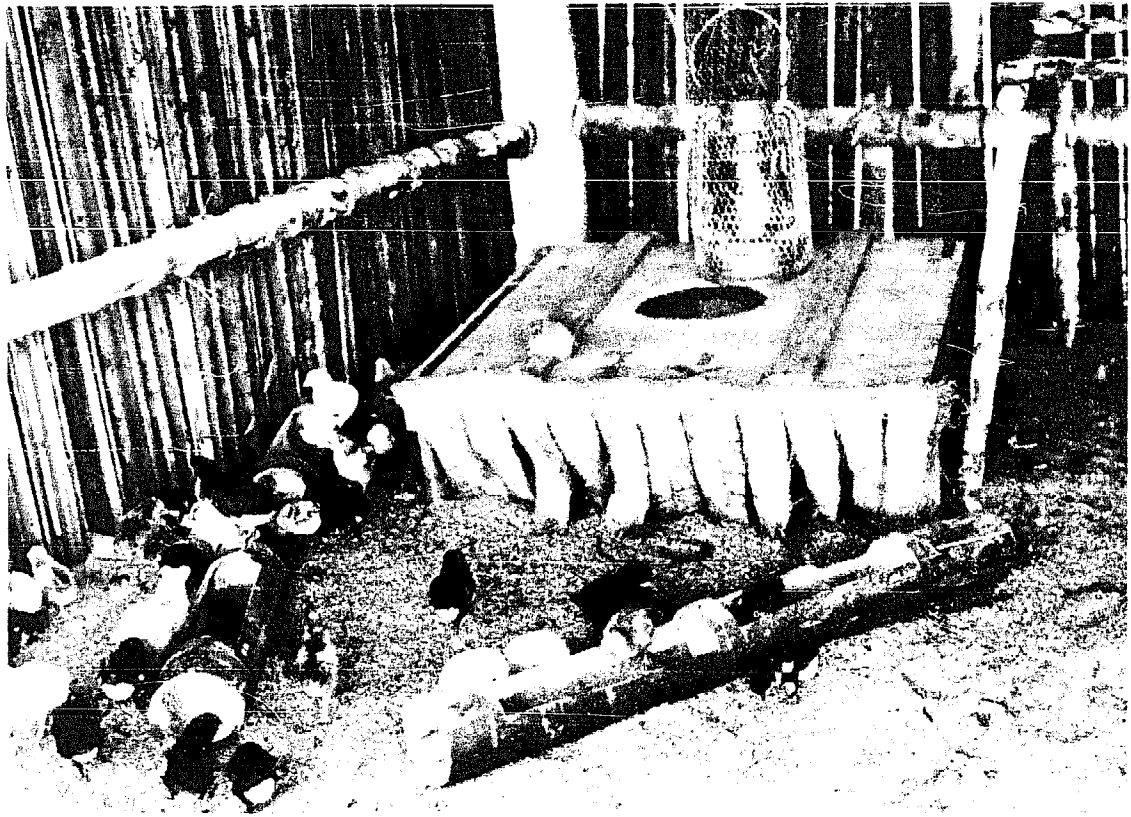

Plate 26 A brooder suitable for highland areas - note bamboo chicken feed troughs.

Highland Areas

It is very cold at night in Highland areas so plenty of heat must be provided to keep the chickens warm. The ideal temperature for a brooder is 35°C which is measured just inside the brooder and 2.5 cms above the floor. As most people will not have a thermometer, a simple way to judge the temperature is to put a hand inside the brooder, and if the temperature feels pleasantly warm, the temperature is just right for the chickens. If it feels hot, the wick of the lamp needs to be turned down.

Warm Earth Brooder

This brooder is suitable when large numbers of chickens are being raised. A special house must be provided for this brooder, with a low ceiling (about 120-135 cms).

A 44 gallon drum is buried half-way into the earth. It has a chimney, a vent for air and a hinged lid so wood can be put on the fire. Some wire or other protection around the drum is necessary so the chickens cannot burn themselves on the hot drum. The fire is lit in the afternoon and with experience, the operator will learn how to adjust the air vent so the fire will burn all night. This brooder is good for the coldest parts of the Highlands.

General Management

The floor of the house is covered with deep litter and the chickens are

14 Timing of Replacement Stock

It is best to cull (sell or dispose of) the laying stock at 18 months of age, i.e., after they have been laying eggs for 12 months. If birds are kept longer than 18 months, it will cost more to feed them than the money the owner receives from the sale of eggs. As the owner is in business and relying on a cash income, he must time the replacement of his laying stock, so that they will start laying eggs, just at the time that his layers have reached 18 months of age. As it takes a bird 6 months (i.e. from day old to 26 weeks) to be raised before it starts to lay eggs, the replacement stock must be bought as day old chickens, when the laying stock that the owner has on his farm are 12 months of age.

If he buys his replacement chickens at this time then they will start to lay eggs just as his present layers turn 18 months of age and so his cash income will not be interrupted:

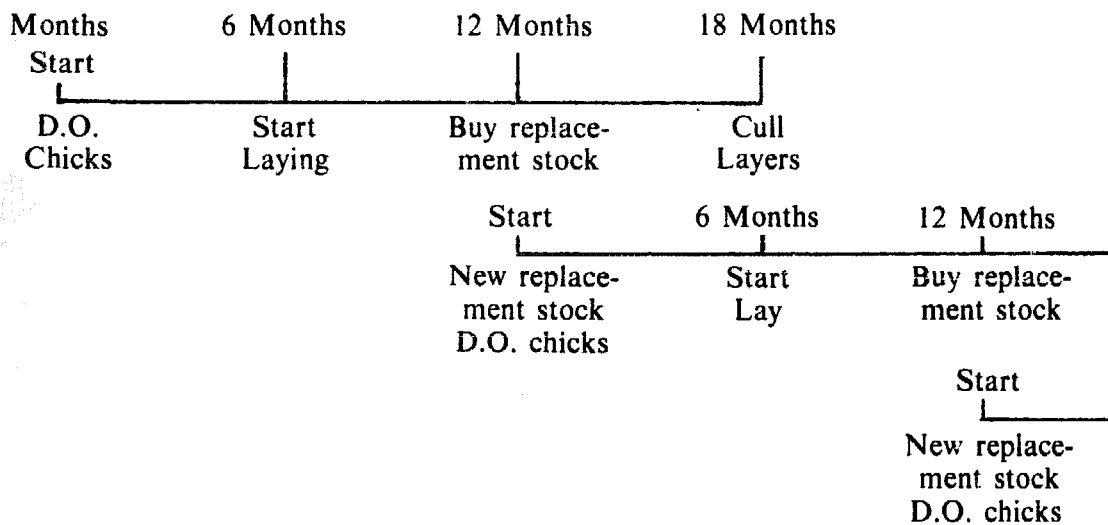

You can see from the above how it is timed for the replacement stock to replace the old layers, without interrupting egg supply.

15 Management of Deep Litter

What is Deep Litter?

Deep litter is any dry material such as coffee mill hulls, rice hulls, peanut hulls, sawdust, dry leaves, wood shavings, finely chopped dry grass, etc., which when placed on the poultry house floor, combines with the birds' droppings and undergoes a bacterial process which gives sanitary non-smelling conditions when handled correctly.

This may sound like a lot of work for the project owner, however:

This is one of the advantages of deep litter — very little work is required to look after it properly. There are only three things that have to be remembered:

- * The shed must be kept dry — roof must be rain-proof; the overhang of the roof must be sufficient to keep the rain from blowing in, and drinking water must not spill onto the litter.
- * The shed must not be overcrowded — see floor space requirements for various ages of Stock in Table 7. If overcrowded, litter becomes hard and disease could be introduced to the house.
- * The litter must be turned. Once a week litter should be raked over to stop it going hard and to mix the birds' droppings evenly throughout the litter.

Some of the advantages of Deep Litter

- * Birds burrow into the litter and cool themselves as the litter maintains a uniform below air temperature in hot weather.
- * Birds burrow into the litter and warm themselves as the uniform litter temperature is above air temperature in cold weather and the litter acts as an insulation against the cold.
- * Birds scratch in the litter which gives them something to do and so stops feather picking, egg eating, and gives them a 'dust bath' which controls lice. Deep litter also provides some vitamins, namely B12.
- * The droppings combine with the litter and, due to bacterial action, no smell will develop and no flies will breed as deep litter is dry.

* Deep litter is a valuable fertiliser. One 10' x 10' house with 25 hens will produce in one year 3/4 tonne of deep litter fertiliser. This will contain the equivalent of —

112 kgms ammonium sulphate (45 lbs nitrogen content)

100 kgms superphosphate (33 lbs phosphorous content)

35 kgms potassium (33 lbs potash content)

5 kgms magnesium

5 kgms sodium

20 kgms calcium

plus trace elements and the valuable organic matter.

It can be seen that it is a valuable by-product of the poultry project.

16 Ducks

Ducks are somewhat easier to look after than poultry as they are hardier, however they still require good feed and good management to get good results.

There are three types of ducks generally available in the South Pacific — Muscovy, Pekin and Aylesbury.

The Muscovy is actually not a true duck as its eggs take 35 days to hatch against the others 28 days.

All the management principles for poultry can be applied very successfully to ducks.

Protein requirements however are slightly lower than poultry and are:

0-4 weeks of age 17%

4 weeks onwards — 15-16%

Ducks do not get coccidiosis therefore the feed does not have to be medicated.

Ducks however are very susceptible to food poisoning known as botulism and therefore the farmer must keep all the feeding utensils and the area where the ducks are fed, very clean.

It is not necessary for ducks to have a pond for them to swim in, however water troughs must be deep enough for the duck to be able to completely immerse its head in water as ducks require regular washing of their eyes.

Pekins and Aylesburies do not breed very well so it is best to hatch their eggs under muscovy ducks.

For breeding purposes one (1) drake to five (5) ducks is sufficient. On good management first year breeding muscovies can be expected to lay 60-90 eggs, 2nd year 30-60 eggs, and selected third year breeders 15-30 eggs, provided the management is good.

To get a duck to hatch more eggs every year, ducklings should be taken away from the ducks at day old and raised artificially the same as chickens.

A house suitable for poultry will be quite adequate for ducks provided precautions are taken with the drinking water to make sure it does not wet the litter. This is best done by pouring a small piece of concrete in the corner of the shed making sure that the slope of the cement is towards the outside of the building. The water trough is placed on the cement.

17 Some Diseases of the South Pacific

1 Coccidiosis

This disease is caused by a single cell protozoan organism which lodges itself in the walls of the intestine of the bird and will cause heavy losses in chickens 4-16 weeks of age.

Symptoms

There will be blood mixed with the droppings. The chickens will not eat and will stand with their wings drooped on the floor and their heads pulled back into the body with the eyes usually kept closed. Their combs are very pale.

Prevention

For young chickens and growing pullets buy a medicated feed or if the feed is being mixed on the farm, add a coccidiostat, such as TOLTRO or PANCOXIN to the feed.

Cure

Add to the **drinking water** a coccidiostat such as TOLTRO. The directions on the tin must be followed very carefully.

Coccidiosis is probably the biggest disease killer of young chickens and poultry farmers should watch their flock carefully for this disease.

2 Leucosis

This is a disease of the nervous system and occurs more in older stock and growing pullets than in young birds.

There is no cure for Leucosis. A vaccine has now been developed which will lower the incidence of the disease considerably. The birds are vaccinated by hatcheries at day old.

Symptoms

The birds appear quite healthy but will have lost control and use of their legs. It is quite alright to eat the birds as the meat is not affected. Birds that get Leucosis will not recover and should be destroyed.

3 Coryza

This disease is like a cold or influenza in humans, and usually affects young chickens.

Symptoms

The birds have difficulty in breathing and the eyes will be covered in a cheesy pus.

Prevention and Cure

Birds fed on a medicated balanced ration rarely get the disease. The best cure is to add AUREOMYCIN to the feed or drinking water.

4 Vitamin Deficiencies

Birds that are free ranged or fed a balanced ration rarely have vitamin deficiencies. However if the feed that is being fed to the birds is very old then some of the vitamins such as Vit. A may be deficient as they lose their strength with age and humid conditions.

Cure

- * Feed only fresh bought feed.
- * Add 40 gms/100 kgs of feed of a Vitamin supplement to the ration.
- * Allow the birds to free range for 1-2 hours per day or add fresh green-feed to the birds ration.

5 Mineral Deficiencies

This will rarely occur in birds that are free ranging and birds that are fed a balanced ration. Calcium deficiency in laying hens could occur and crushed sea shells or coral or if this is not available some limestone, should be placed in a box in the corner of the shed.

6 Fowl Pox

When ordering chickens from a hatchery it is wise to have the chickens vaccinated against fowl pox. It will only cost one cent per chicken. Fowl pox is spread by mosquitoes.

Symptoms

It occurs mostly in chickens from 1 week to 10 weeks of age. The eyes, beak and head will be covered with scabs. Most of the birds will recover from the disease, but their growth rate slows down a lot.

Cure

Vaccination is the only cure. There is no drug treatment.

7 Protein Deficiencies

In the South Pacific area protein deficiency is very widespread as there are virtually no natural high protein grain or plants available to poultry.

Symptoms

- * Very slow growth rate of young chickens and sometimes death.
- * In older birds, the breastbone is very pronounced and the birds are very thin. At a later stage, the bird becomes very lazy and weak, walks with great difficulty and will eventually die.

Cure

- * feed a high protein feed, such as meat meal, or poultry concentrate with the kau kau or other energy type feed being fed
- * boil up some fish and mix with the other feeds
- * if such crops as soybeans, peanuts, mung beans, snake beans are available, mix this with the other feed.

8 Botulism

This is food poisoning and usually occurs more with ducks than poultry. It is caused by bacteria growing in stale wet feed, that that has gone putrid.

Symptoms

The birds will sit down and extend their necks out as far as possible and will be very drowsy. Death occurs in 1-4 days.

Prevention

- * thoroughly clean out feed troughs after every feeding, (if the birds are fed outside)
- * change the site of feeding regularly, so that the ground under the feed trough doesn't become saturated with feed.

Cure

There is no cure.

9 Fatty Liver of Laying Hens

This usually occurs only to birds confined to laying cages. The birds are confined to a small area and consequently get very little exercise. High producing hybrid birds are more prone to fatty liver than pure bred stock such as Australorps or Rhode Island Red.

There is very little that can be done for fatty liver as the first thing that the farmer knows about it is the bird has died.

Glossary of Terms

Pigs

Baconer — a pig suitable for the curing trade

Balanced ration — a ration which meets all the nutritional requirements of the pig

Barrow — a castrated male pig

Boar — a male pig

Creep Area — an area of the farrowing pens specifically for the piglets

Creep Feed — a high protein feed fed to piglets in the creep area

Colostrum — the milk produced in the first 48 hours after farrowing which is very rich

Farrow — to give birth to piglets

Gilt — a maiden sow

Lehmann System — a system of feeding pigs based on potatoes

Maintenance ration — the amount and type of food necessary to keep the sow in good health and at a constant weight.

Oestrus or heat — the period of time a sow or gilt is able to be mated (occurs at 21 day intervals when sow is not pregnant)

Piglet — a pig suckling a sow

Porker — a pig suitable for the fresh pork trade

Protein concentrate — a specially prepared mixture of various high protein goods supplemented with vitamins

Sow — a female pig

Wean — to separate piglets from the sow

Weaner — a weaned pig

Poultry

Layer — an adult female hen

Rooster — an adult male bird

Pullet — an immature hen (6-24 weeks of age)

Chicken — a bird 0-6 weeks of age

Nest — a box usually 12" x 18", where a hen lays her eggs

Roost or Perch — a piece of timber on which a bird sleeps

Self Feeder — a container which allows birds to feed themselves and only needs refilling once or twice per week

Brooder — a source of heat for young chickens

Deep Litter — any dry friable material which will absorb birds droppings and enhance bacterial action

Surround — a device to contain chickens in a given area to stop them from smothering

Broiler — a bird specially bred for meat production

Appendix

Establishing a school pig project

Many schools try out various agricultural projects with different results. Some projects are successful because they are well planned while others fail because not enough care is taken.

This section shows how a project should be planned and how a school can develop a project using this book as a reference.

Before starting any plans the local agricultural or livestock expert should be asked for his advice and help. This man or woman can provide much help over the whole development period and even after when urgent advice may be needed. Having talked about the project with the agricultural expert the type of piggery must be decided upon (chapter 1). If a semi-intensive piggery is decided upon the project must be developed in a different way to what is needed for a fully intensive piggery.

A lot of thought must be given to the type of feeding to be used. In most schools left-overs and scraps from the kitchen will form the basis of the diet but in some cases it will be easier to buy prepared rations from the local store or miller. If sweet potatoes are to be grown for the pigs a supply of concentrate has to be found. Similarly, if prepared rations are to be used then a suitable supply must also be found. On the other hand if a grazing project is going to be built (and this is probably the best type for a school which has land but not much money) a suitable area must be planted before any pigs can be bought (chapter 1).

At this stage the economics of feeding the pigs should be looked into to make sure that it is profitable to build a piggery. The best person to help when this is being done is the local agricultural officer. He is trained in these things and would be a very valuable person to talk to.

The next step is to select a site (chapter 3). The availability of food, water, access, drainage, relationship to the school (ask the health inspector for his ideas) and many other things must be thought of.

If an intensive piggery is planned now is the time to design the building (chapter 3). Every builder needs a plan to build from and if students are going to build the pig house then they most certainly will need a plan.

A plan is something which must be very carefully thought about and not rushed into. Once the building is built it is quite often too late to correct any mistakes and even if the mistakes can be corrected it will cost more money to do so.

By drawing up a very carefully prepared plan the materials needed to build the piggery can be worked out and so the estimated total cost can be found out.

Having done all of this, and having decided to continue with the project it is time to start work.

The site must be levelled, all of the post holes dug, the posts cemented in and the floor form-work placed in position if a concrete floor is to be used. It is a good idea to put the roof on first so that the workers can work in the shade and work under shelter if it rains.

Once the floor and roof are completed the walls and gates can be made. By now the project will start looking like a piggery and some thought can be given to selection of breeds and where the pigs are to be bought from (chapter 4).

When the building is finished it is a good idea to let it stand empty for four to six weeks, this will allow the cement to dry properly so that it will last longer. During this time the drainage can be checked to make sure that there is enough slope on the floor and drains.

A feed store and office can be built alongside the piggery also as feed must be stored close to the pigs and the records must be handy also. Before buying the pigs (chapter 5) a supply of feed must be bought and put in the feed shed as the pigs will need to be fed the day they arrive. At this time it is a good idea to make sure that there are feed and water troughs in each pen.

When the pigs arrive the work really starts. They must be fed each and every day of the year — holidays included. They must also be watered — most important in the tropics. A close watch must be kept on their health (chapter 7) and records must be kept (chapter 6). To make sure the project is working properly ask the agriculture officer to visit regularly — say once a month.

When holidays are nearing plans must be made to make sure that someone will look after the project and will look after it properly.

A constant watch must be kept on the feed supply. It is most important that feed does not run out.

The following chart lists the steps in developing two types of projects:

Step	1 Consult agricultural officer.	
	2 Decide upon management system to be used.	
	Semi-intensive	Intensive
3	Select site for gardens	Decide on feeding practice
4	Fence garden	Select site for building
5	Start planting garden	Plan building
6		Build pig house
7	Decide on breed type	Decide of breed type
8	Select and buy stock	Select and buy stock
9	Work out roster	Work out roster
10	Work out record system	Work out work system

If these steps are followed then the project has a very good chance of success. How successful it will finally be depends upon the level of management put into the project. Happy and keen workers are much better than dull and uninterested people. Keep all the workers on the project. In this way everybody will gain from the experience and the school will benefit as well.