

EM 32

The basics of chicken farming (in the tropics)

Bart Gietema

© Agromisa Foundation, Wageningen, 2005.

All rights reserved. No part of this book may be reproduced in any form, by print, photocopy, microfilm or any other means, without written permission from the publisher.

First edition: 2005

Author: Bart Gietema

ISBN: 90 5285 006 2

NUGI: 835

Foreword

This guide offers ‘the basics’ of chicken farming. It is a title in the AGROMISA series of educational materials on agriculture & animal production in warm climate zones.

The guide does not treat the financial-economic aspects of chicken farming. However, in the above AGROMISA collection there is a special training text on the economics of farming including chicken farming.

Certain sections are partly based on texts provided by Mr A.H. van Apeldoorn, written within the context of an international cooperation project financed by the Netherlands Government.

Other sections are based on texts provided by IPC Livestock, Barneveld College, here in the Netherlands. The names of the authors of the original texts have been mentioned where they were known.

Another source has been material published by the Ministry of Agriculture, Nature Conservation and Fisheries in the Netherlands; e.g. Chapter 1 has this origin.

Lately Dr.E.H.Ketelaars, emeritus professor of Wageningen Agricultural University, has been so kind to critically read and re-arrange the text.

Dr Ketelaars is also the author of our guide ‘Lecture Notes on Chicken Farming in Warm Climate Zones’ which describes and discusses mainly the physiological background of the managerial measures outlined in the underlying guide (the ‘basics’ text).

The photo on the cover shows a parentstock operation (Muyuaka Farm, Cameroon).

AGROMISA is most grateful to all persons and institutions that made a textual contribution to this chicken farming guide.

The drugs and chemicals mentioned in the text, as well as their application and use, only serve as an aid in instruction.

No warranties are expressed or implied as to the accuracy and adequacy of the information, nor are those companies whose brand names or products are listed, endorsed.

Compilation, editing and layout by

B.Gietema

IJhorst, NL

November 2004

E-mail: <gietema64@hetnet.nl>

Contents

1	Some aspects of chicken biology	6
1.1	External features	6
1.2	Chicken breeds	7
1.3	The organs of the digestive tract and the digestive process	10
1.4	The reproductive tract of the hen	12
1.5	The respiratory tract	14
1.6	Skeleton	15
1.7	Heat regulation	16
2	Housing	18
2.1	Housing systems	18
2.2	Discussion of housing systems	20
2.3	Construction of a non-climatized chicken house	24
2.4	Conditions in the chicken house (the 'climate')	25
2.5	Lighting chicken houses	26
2.6	Feeding equipment	28
2.7	Water equipment	33
2.8	Laying nests	42
3	The feeding of chickens	45
3.1	The composition of chicken feed	45
3.2	Mixing feed	47
3.3	Grinding and pelleting	48
3.4	Feed intake and feed conversion rate	49
3.5	Water supply	52
4	Management of pullets	54
4.1	The management of chicks from 1 day to 8 weeks old	54
4.2	Management of growers	57
4.3	Cannibalism	61
4.4	Debeaking	63
4.5	Checklist for the growing period	65
5	Management of laying stock	68
5.1	Preparing the house for layers	68
5.2	Feeding the layers	68
5.3	Managing the flock	69
5.4	Culling and selection	70
5.5	Daily routine jobs in the chicken house	71
5.6	Records to be kept	73
5.7	The egg	74
6	Management of breeder flocks (= parent stock)	77
6.1	What should have been done before breeding starts?	78
6.2	The importance of correct body weight	78
6.3	Measures to improve fertility	79
6.4	Hatching egg production	80
6.5	Guidelines for the selection of breeding stock	81
6.6	Recycling of the breeder flock	83

7	Broiler and roaster production	84
7.1	Broiler production	84
7.2	Roaster management	87
8	Infectious diseases and their prevention	88
8.1	Production hygiene	88
8.2	Flock observation and health control	90
8.3	Cleaning & disinfection of chicken houses	96
8.4	Infectious diseases in chickens	99
8.5	Diagnosing poultry diseases	107
8.6	Immunity and vaccination	108
8.7	Treating chicken diseases	115
9	Diseases caused by parasites	122
9.1	Coccidiosis	122
9.2	Blackhead (other names: histomoniasis; enterohepatitis)	130
9.3	Worms	130
9.4	Ectoparasites	130
10	Waste management	140
10.1	Chicken droppings	140
10.2	Control of flies	144
11	Incubation and hatching	145
11.1	Incubation	145
11.2	Hatching and delivery of day-old chicks	152
12	Non-industrial killing, dressing & packing	156
	Appendix 1	159
	Appendix 2	162
	Appendix 3	169

1 Some aspects of chicken biology

1.1 External features

The head:

- the comb
- eye and eye-ring
- nostrils (nose openings)
- wattles
- earlobes
- neck

the body:

- the breast
- back
- tail
- belly

the limbs:

- the wings
 - upper arm
 - lower arm
 - 'hand'
- the legs
 - upper leg
 - lower leg or shank
 - toes (4) + webs
 - hock or spur
 - claw (nails)

The chicken is covered with feathers, skin and scales (on shank and feet).

The feathers protect the body against injuries and have an insulating function. There are flight feathers, body feathers, hair feathers and down feathers (fluff).

Each part of the chicken body has its own type of feathers.

Feathers vary in size and shape but they always have the following parts:

- quill (hollow stem)
- shaft (rib)
- accessory plume
- web or vane
- barbs (branching from shaft for interlocking)

Feathers are shed and replaced at certain intervals (i.e. *moult*):

- at 4-5 weeks of age
- 8 weeks
- 13 weeks
- 20 weeks

and approximately once a year during the laying period, but also in periods of disturbances of all kinds: feed deficiencies, climate changes, etc.

Table 1: Differences between males and females

Cocks	Hens
mostly bigger than hens	
comb, wattles and earlobes usually bigger	
larger tail	
longer and pointed feathers	shorter and rounded feathers
bigger spur	

1.2 Chicken breeds

There are more than 300 breeds of chickens the world over, most of them being so-called land races or local breeds. The *commercial* breeds can be divided into three groups:

a egg producers (lightweight laying breeds)

The most important representative of this group is the Leghorn (WL). Well known characteristics are:

- 1 high egg production
- 2 little broodiness
- 3 low feed consumption

But its value as meat producer is limited and the eggs are white; usually white eggs fetch a somewhat lower price than brown eggs.

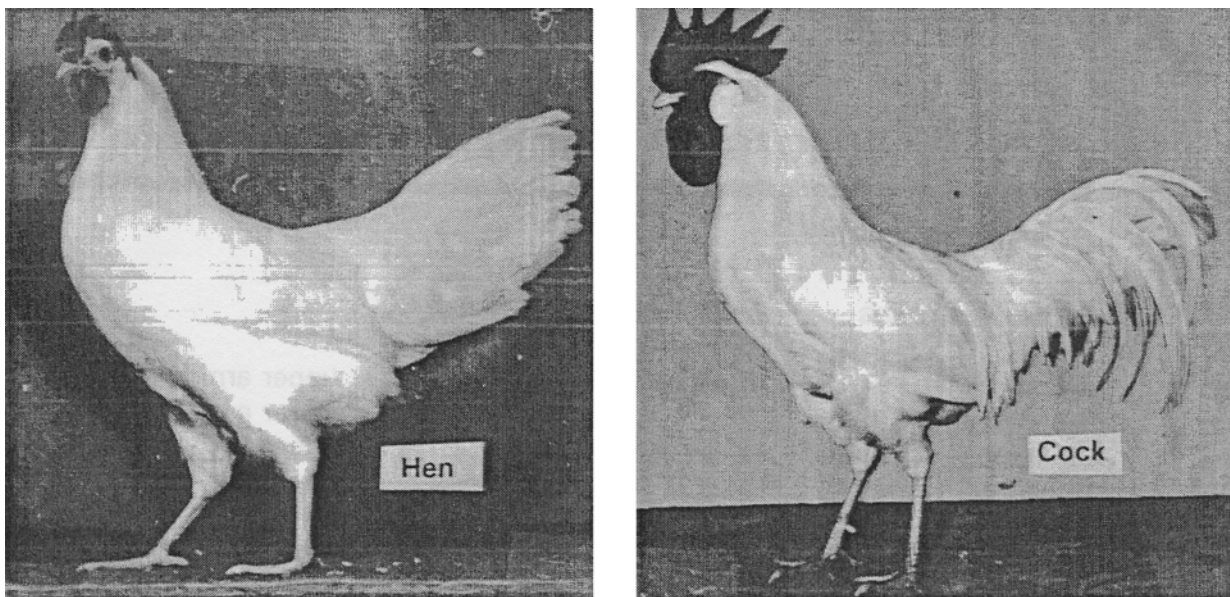

Figure 1: White Leghorn

b meat and egg producers (dual purpose breeds)

Important representatives of this group are Rhode Island Red (RIR) and New Hampshire (NH).

Characteristics:

- 1 brown eggs
- 2 broodiness
- 3 higher feed consumption than WL
- 4 better meat producers than WL and less nervous

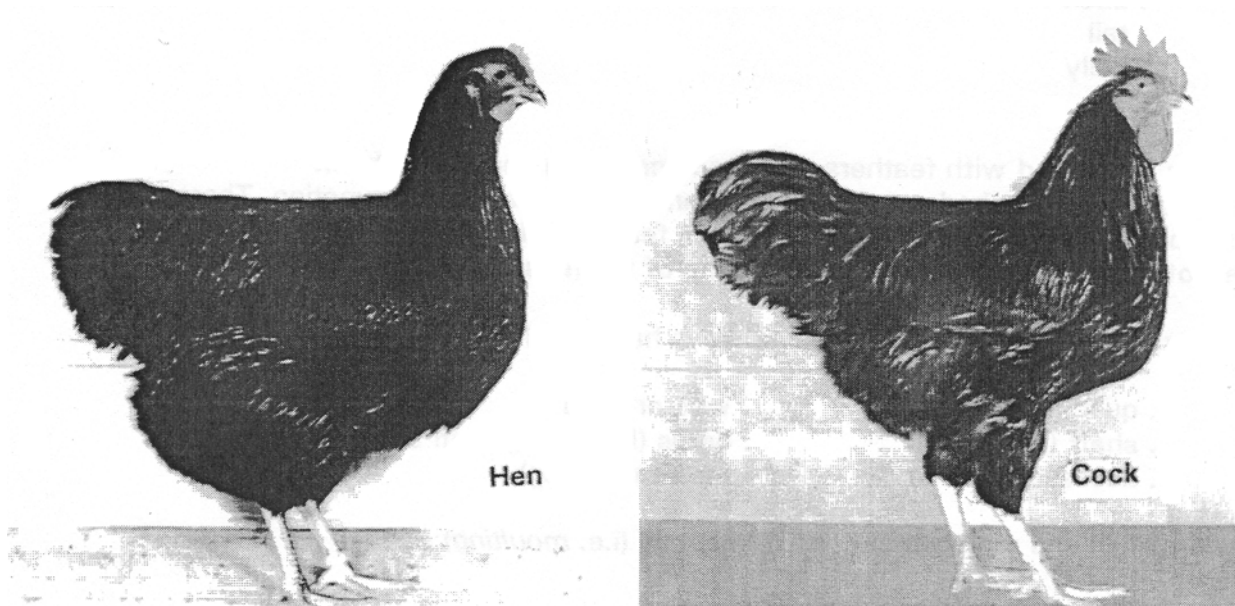

Figure 2: Rhode Island Red

c meat producers (heavyweight breeds)

White Cornish (WC) and White Plymouth Rock (WPR) are important meat producer breeds. Characteristics:

- 1 low egg production
- 2 much broodiness
- 3 fast-growing chicks
- 4 high weight at maturity

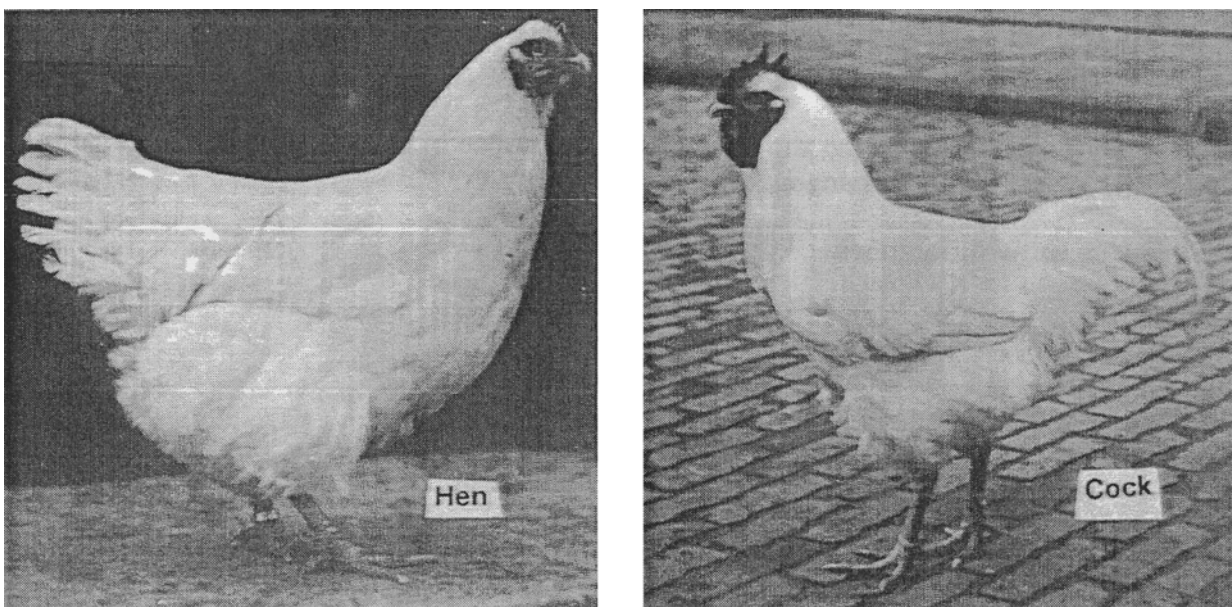

Figure 3: White Plymouth Rock

Breeding and multiplication

Nowadays actual breeding is the work of large companies which operate internationally.

What they do:

- the development of (new) lines or strains in chicken breeds
- the testing of crosses between these lines, in order to find the best combination

➤ delivery of parent stock (as chicks) to multiplication farms

The first generation of cross breeds obtained is generally superior to the parents. This is known as ‘hybrid vigour’, which manifests itself in particular in ‘fitness’: fertility (number of eggs and their fertility), hatching results and viability of newly-hatched chicks (e.g. resistance to diseases).

A form of ‘hybrid breeding’ is the following 3-way crossing:

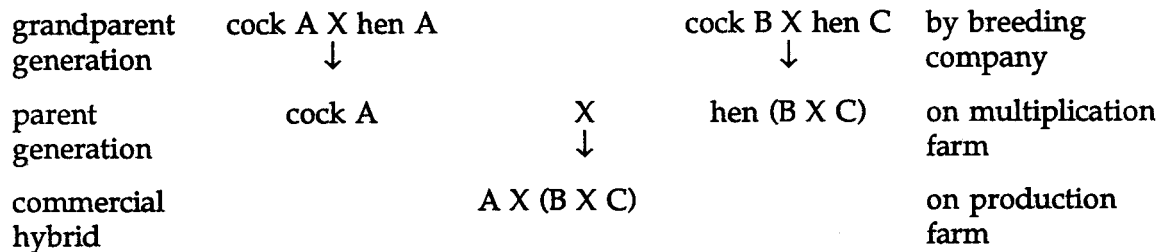

Figure 4: A, B and C may be strains or lines of the same breed or from different breeds. Crosses from four or even more lines also exist, especially in the broiler sector.

What is the job of *multiplication farms*:

- 1 the rearing of parent stock to sexual maturity
- 2 the mating of parent stock and delivery of hatching eggs to hatcheries.

The job of *hatcheries*:

- 1 the hatching the eggs obtained from multiplication farms
- 2 the delivery of day-old chicks directly to production farms (layers or broilers) or to rearing farms.

On *rearing farms* day-old chicks are reared to sexual maturity and then delivered to *production farms* (in the laying sector).

1.3 The organs of the digestive tract and the digestive process

The following is a brief description of the characteristic features of digestion in chickens (it applies to poultry in general).

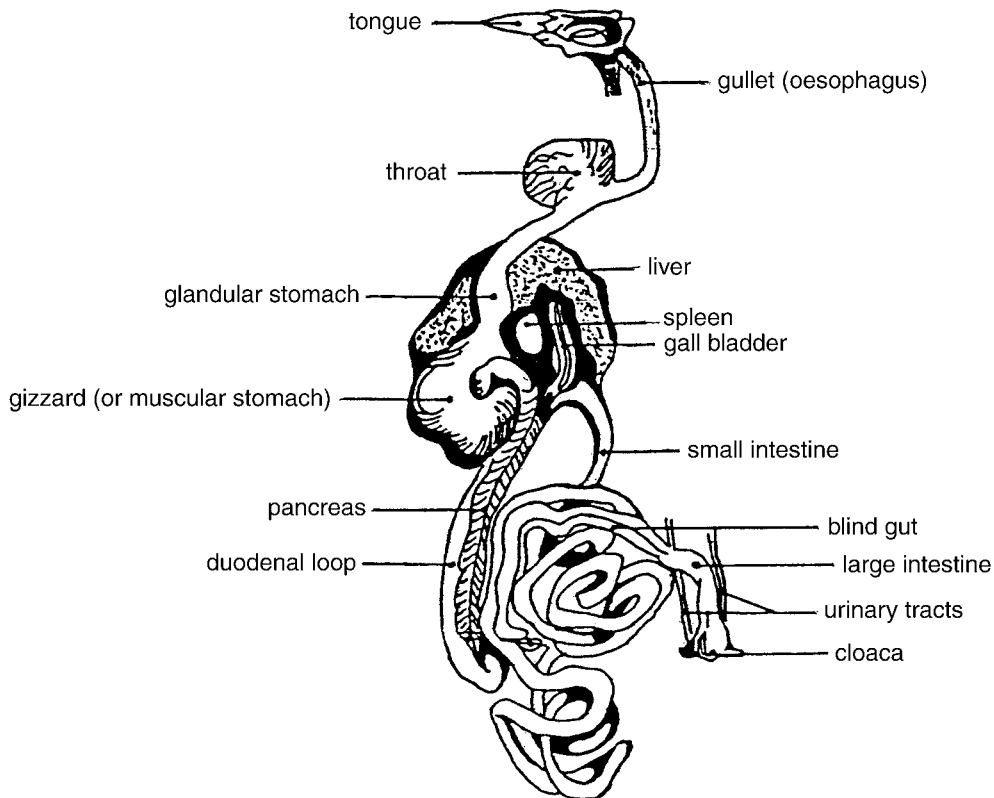

Figure 5: The digestive tract

Beak (the 'mouth' of birds)

Chickens have no lips, cheeks or teeth.

The beak is composed of two horny parts: the upper beak is attached to the skull, the lower beak is hinged.

The feed is picked up after which it passes via the gullet (oesophagus) to a pouch known as the crop. The passage is by gravity and air pressure differences.

The feed is not chewed. The spittle (saliva) that is produced in the beak contains no digestive juices and merely serves to make the feed smooth and moist.

With chickens, swallowing is easy due to the elasticity of their gullet.

To drink, chickens are obliged to raise their head, to tip the water into pharynx and gullet.

Crop

The crop softens the feed and serves to store the feed. From here the stomach of the chicken is regularly replenished with feed.

Glandular stomach (also called first stomach)

This is the enlarged part of the gullet just before its connection with the gizzard. In its wall are many glands that secrete hydrochloric acid (HCl) and enzymes.

Gizzard (or muscular stomach)

The gizzard is the actual stomach of the chicken. Its wall is very muscular. The muscles contract 2-4 times every minute. These contractions together with the grit present in the gizzard grind down the feed and this makes the gastric juices more effective.

The grit in the stomach is taken up with the feed; an adult chicken needs about 10 to 15 g of grit per fortnight.

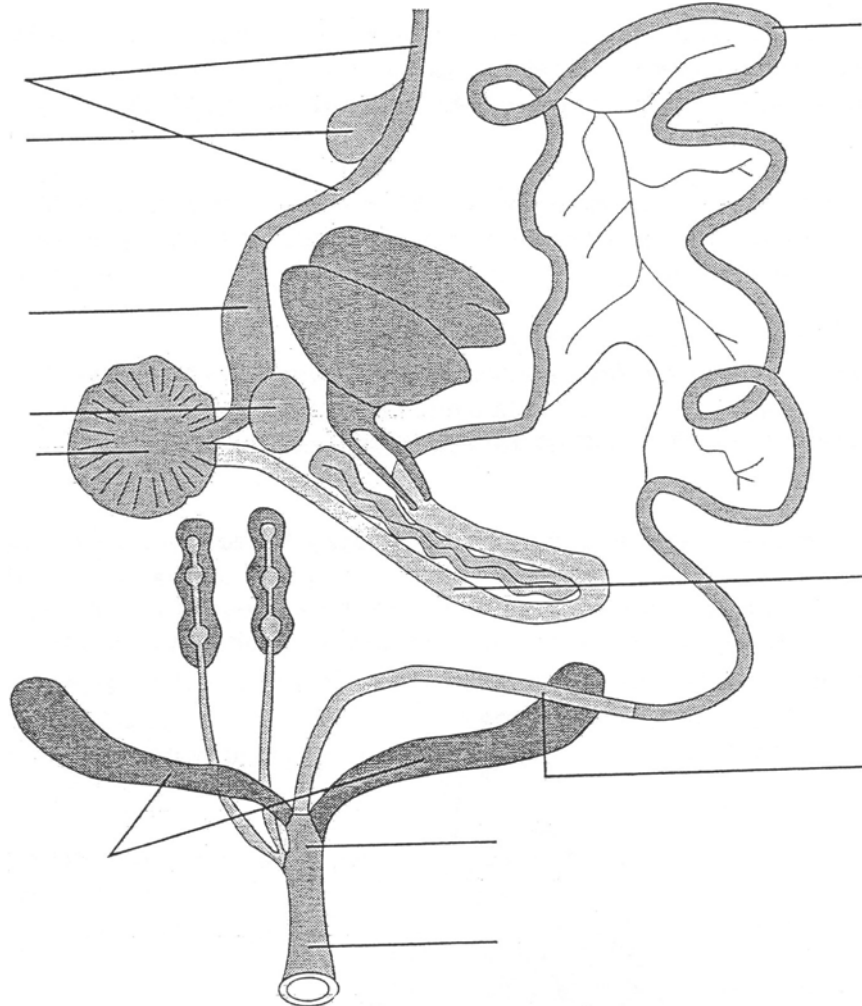

Figure 6: The internal organs (schematically)

Small intestine

The small intestine is about 1.5 m long in an adult chicken.

The first part of it forms a loop known as the duodenal loop in which most of the intestinal digestion takes place.

Imbedded in the loop is the pancreas, which secretes the pancreatic juice. The liver and the gall bladder also secrete products into the small intestine.

The nutrients resulting from the digestive process pass into the bloodstream through the wall of the small intestine.

Between the small and the large intestine are two *blind guts* (= caeca). The digestion of crude fibre in the feed only takes place in these blind guts, with the help of bacteria present there.

Large intestine

The large intestine is relatively short - only about 10 cm.

About 80% of what remains of the feed passes directly from the small intestine to the large intestine.

In the large intestine the feed loses part of its moisture.

Cloaca (= the vent)

The bulbous area at the end of the digestive tract is known as the cloaca. Cloaca means 'common sewer': the digestive, the urinary and the reproductive tracts all empty into the cloaca.

As birds do not have an urinary bladder, the urine from the kidneys is constantly added to the feed remnants. This leads to the formation of the whitish uric acid salts so characteristic of bird excrements.

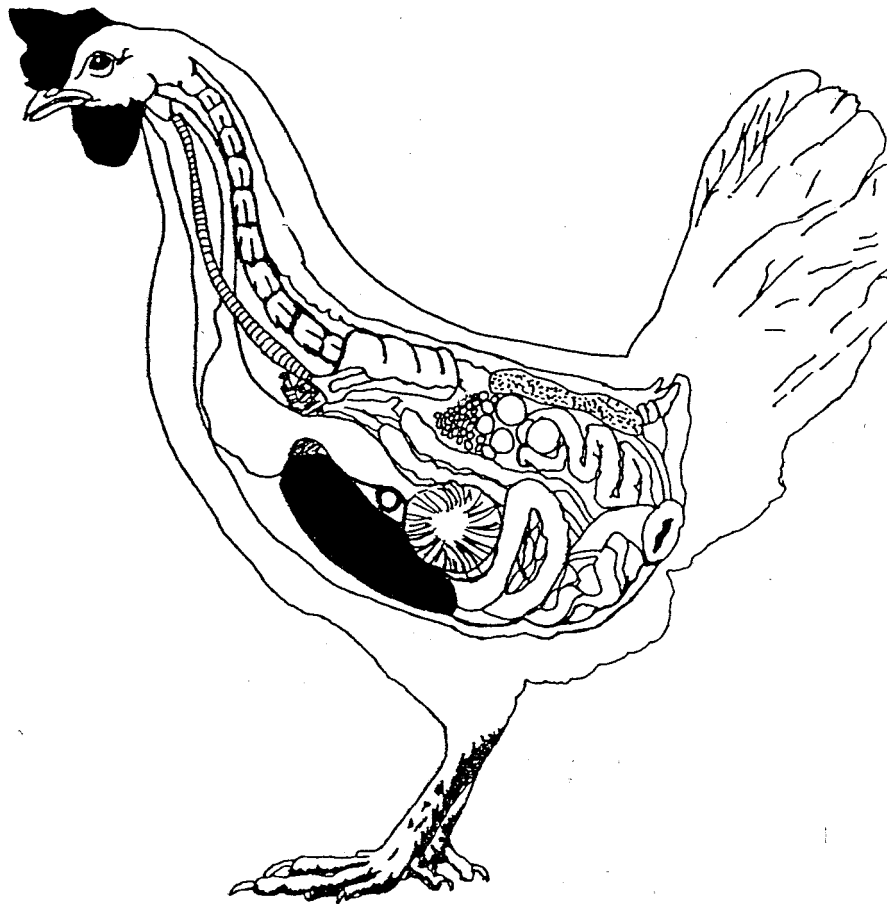

Figure 7: Localization of internal organs

N.B

In the STOAS guide 'biology practicals' there is a practical on the chicken heart.

1.4 The reproductive tract of the hen

The reproductive tract of the hen consists of two separate parts, the *ovary* and the *oviduct*.

The **ovary** has a few thousand follicles. A follicle contains a future egg yolk. The yolk should be seen as a large egg cell with a lot of food reserves. Not all follicles develop. When a hen is laying eggs, her ovary contains follicles in different stages of development. One or two may be the size of the yolk of a normal egg. Nutrients are needed to make the yolk grow and these nutrients are supplied by the blood, via (tiny) blood vessels.

When a follicle is fully developed, it ruptures and releases the yolk. Normally the rupture happens at a place where there are not blood vessels. If this is not the case, then there is some bleeding resulting in blood spots on the membrane that surrounds the yolk.

The oviduct

After rupture, the yolk is 'caught' by the funnel (infundibulum) of the oviduct. The rest of the egg is formed in the oviduct, around the yolk. This represents about 2/3rd of the weight of the final egg and takes about 25 hours.

The length of the oviduct of a laying hen is about 75 cm. The oviduct is supported in the body cavity of the hen by various ligaments. The yolk is pushed forward in the oviduct by contractions of the wall of the oviduct.

In the wall of the oviduct are glands that secrete the substances that we find around the yolk, to 'finish' the egg. The egg is built up in layers, one layer after another.

Usually five different sections are distinguished in the oviduct. As follows:

Table 2:

Section	Formation of	Duration
infundibulum	1 (fertilization) 2 yolk sac (membrane)	¼ hr.
magnum (albumen secretion)	1 'white' of the egg 45% 2 chalazae, which help to keep the yolk in place	3 hrs
isthmus	1 'white' of the egg 10% 2 the two egg membranes	1 hr.
uterus	1 'white' of the egg 45% 2 the shell of the egg 3 the shell cuticle	21 hrs.
vagina		-
total about		25 hours

The oviduct ends in the **cloaca**.

At the time the hen lays an egg, the vagina surrounds the egg and even sticks partly out of the cloaca. In this way the egg is not contaminated by the bacteria present in the cloaca.

A hen can always lay eggs. When there is a normal cock around, the eggs are fertile. Without a cock around, the eggs are sterile and cannot hatch.

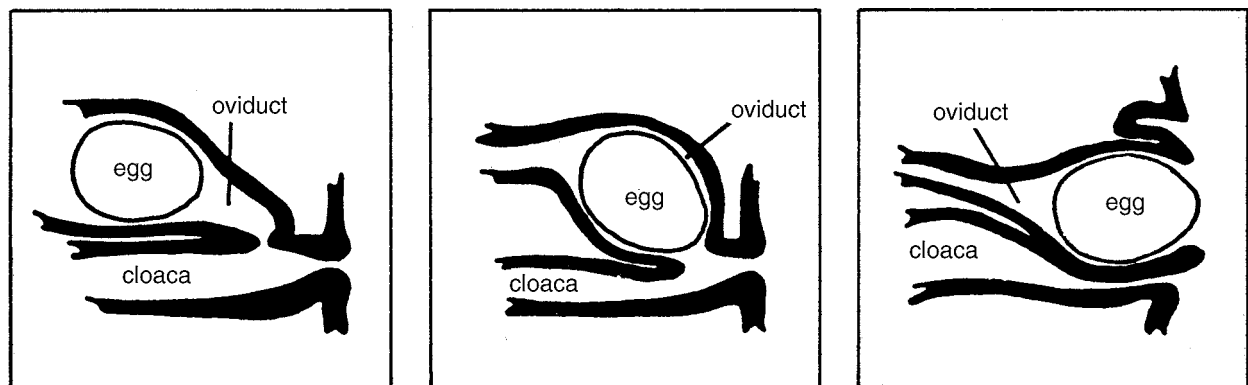

Figure 8: The cloaca is closed off at egg laying

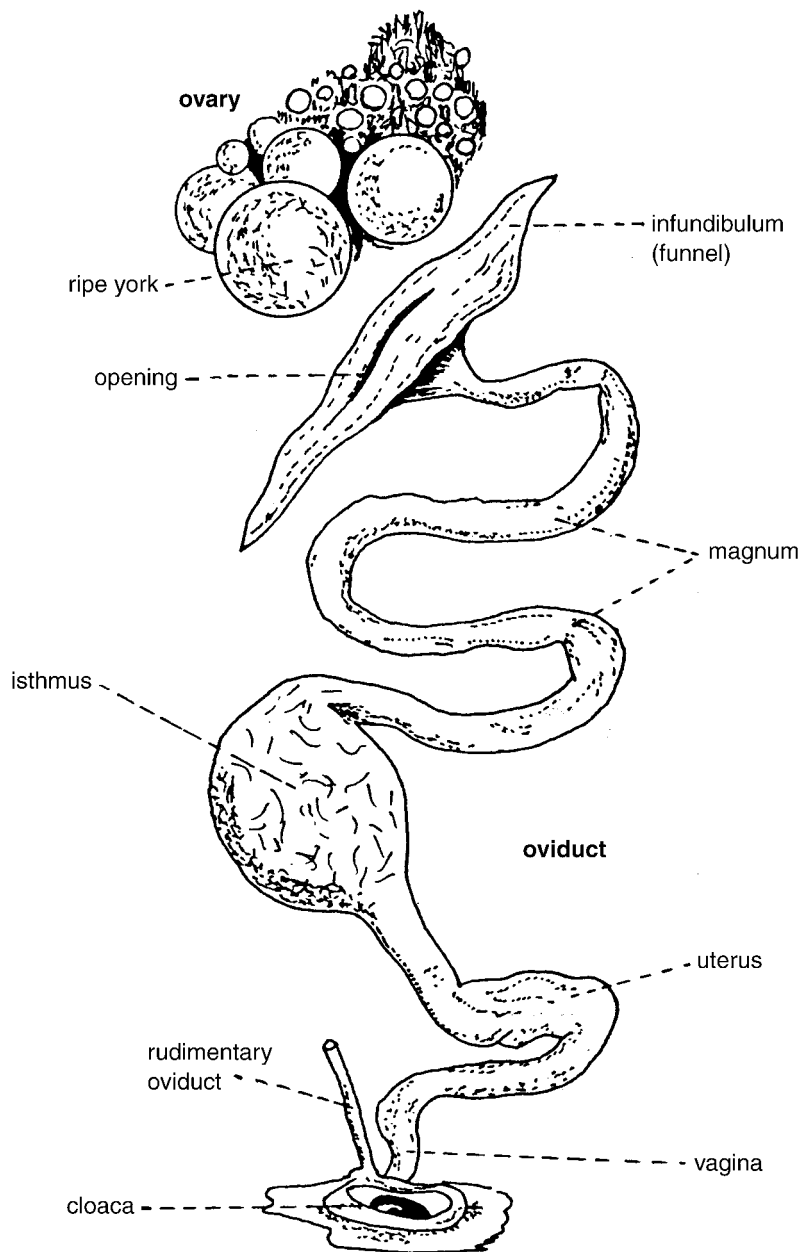

Figure 9: Ovary and oviduct

1.5 The respiratory tract

The *windpipe* (trachea) starts in the throat and ends in the two main bronchi.

The windpipe is made of adjacent rings of cartilage; these rings are rigid and prevent the collapse of the windpipe.

Each bronchus leads to a lung. They branch into smaller bronchi. The lungs of chickens are relatively small. They consist of spongy material fixed to the ribs.

Some of the bronchi unite after passage through a lung, thus forming larger bronchi ending in *airsacs*. Some larger bronchi lead directly to airsacs. Airsacs are storage places for air; they decrease the density of the body, make birds air-mobile and enable them to float on water (ducks).

Airsacs are difficult to locate in the carcass of a bird, but they are easy to find when the sacs are inflated.

The sound-producing organ in birds is called *syrinx* and is found at the bifurcation of the windpipe and *not* near the throat like in mammals. This explains why a chicken after the head has been cut off is still able to produce sounds.

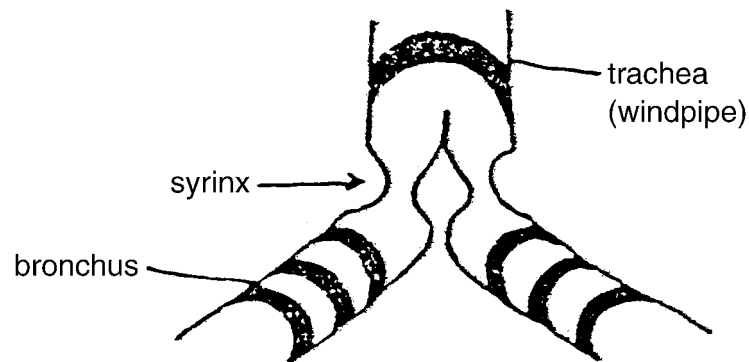

Figure 10:

1.6 Skeleton

The *bones* of chickens are relatively light due to the fact that most of them have air-filled holes communicating with the airsacs, which in their turn communicate with the lungs.

Chickens have 14 neck *backbones* (mammals 7) which gives extreme mobility to the neck of a chicken.

In chickens the *sternum* (= breastbone, keelbone; point of fixation for the wing muscles) is highly developed and ends in a projecting bone plate.

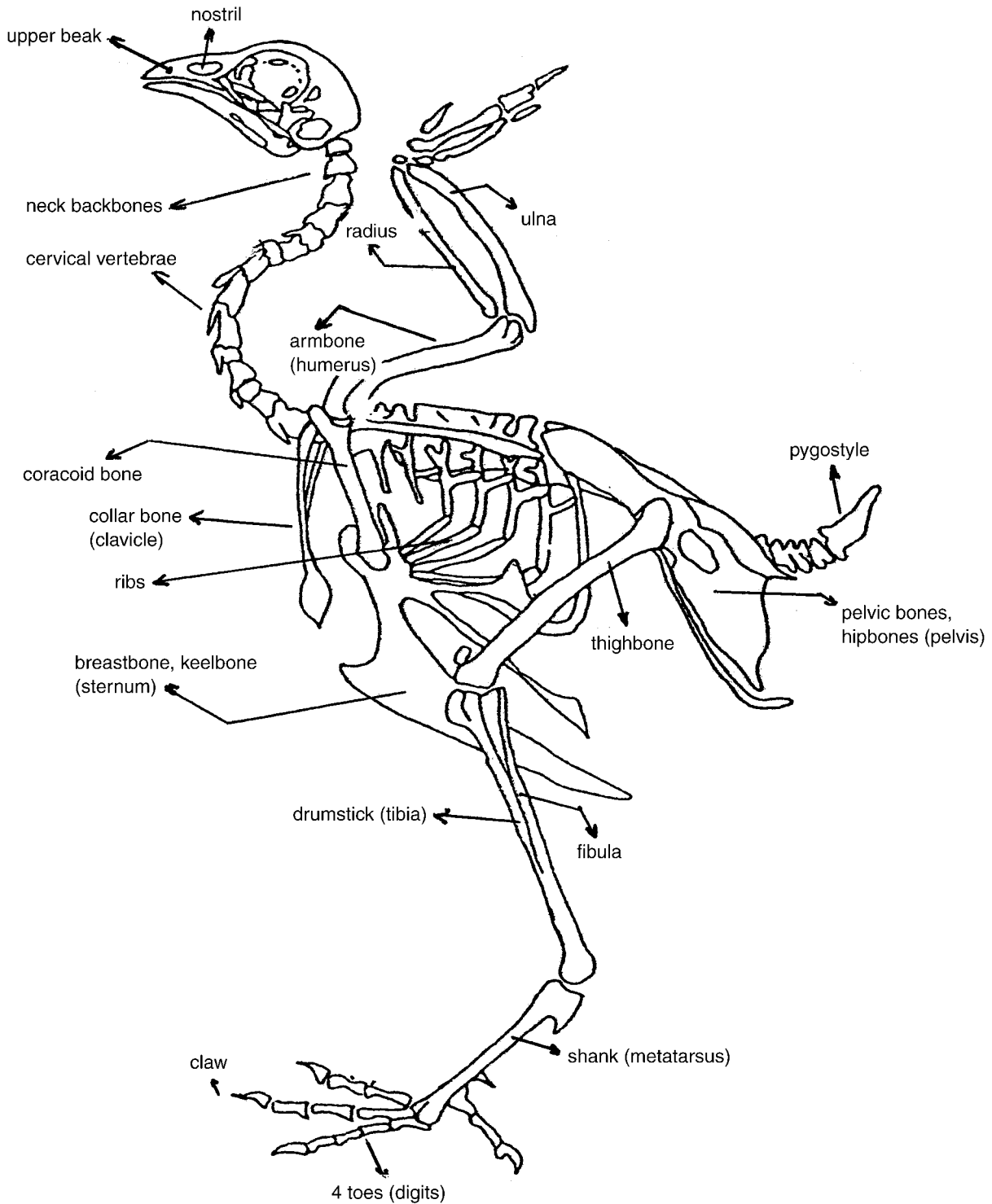

Figure 11: Skeleton

1.7 Heat regulation

Birds do not possess sweat glands like mammals.

Adult poultry can maintain their body temperature on about the same level of 41-42 °C over a wide range of ambient (surrounding) temperatures. An ambient temperature between 15 and 25°C suits the hen best. Above and below these temperatures a *heat regulation mechanism* starts functioning. We distinguish:

1 the ambient temperature is **too low**

The hen is then inclined to:

- shake her feathers out (thermal insulation)
- eat more food (this generates more body heat)
- shiver thus generating heat (muscular movement)

Note that day-old chicks cannot regulate their body temperature at low ambient temperatures, but this ability increases with age.

2 the ambient temperature is **too high**

The hen has several ways of diminishing the effect of temperatures higher than the desirable temperature:

- muscular effort is avoided and the hen tries to seek the coolest place (burrowing into the litter)
- wings are held away from the body, to increase the body surface for heat exchange and to reduce insulation; the neck is stretched out
- when this is not enough, the birds start panting: more respiration; this means a more intense heat exchange in the lungs as more water vapour is breathed out (the chickens will need more water! try to provide relatively cool drinking water)
- if this continues for a longer period of time, without interruption by cool periods (at night), feed consumption drops especially when there is not enough drinking water; this leads to a decreased generation of body heat. At the same time production decreases

It is especially the combination high temperature & high relative humidity which makes it very difficult for chickens to get rid of their surplus heat.

Note that with increasing ambient temperature the hen becomes less productive!

2 Housing

A properly constructed chicken house, regardless of its size and the materials used, has certain essential features:

- a watertight roof
- proper ventilation
- inner surfaces which are easy to clean
- rat and wild bird proof floor, walls and roof
- correct location

Location

Sometimes there is no choice, but if there is a choice, features for a good location are:

- well-drained land; this is especially important where litter systems are used
- within sight of owner/supervising personnel
- away from other chicken houses, to reduce the spread of diseases; in general, the more distance, the better
- especially in hot climates, having tall trees which cast shade on the roof, is an advantage; however, the natural air flow (wind) should not be hindered
- no direct sunshine entering the house; placing the house in an east-west direction is best
- think of transport of birds, feed and eggs.

Floor

The ideal floor for a poultry house is a smooth, strong concrete floor with a slight slope so that it is easy to clean.

Holes or cracks are a health risk (coccidiosis!) because it is very difficult to clean such a floor effectively.

2.1 Housing systems

Poultry housing systems vary from the small backyard flock only having simple night shelter ('extensive' poultry farming), to modern poultry houses with thousands of birds in controlled environment houses ('intensive' poultry farming). In more intensive systems in hot climate zones, there are two options: open houses in wet climates and closed (environmentally controlled) houses in dry regions.

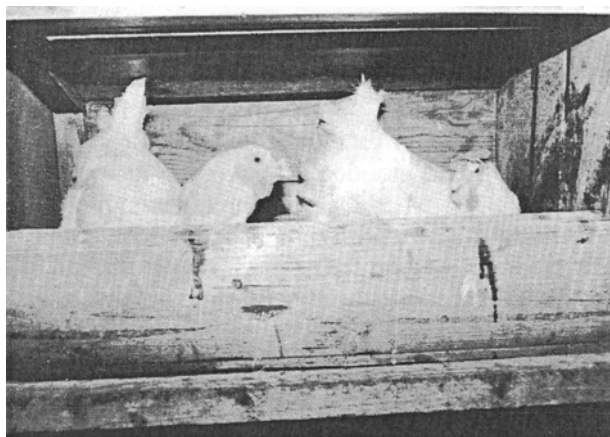

Figure 12: Communal nestbox

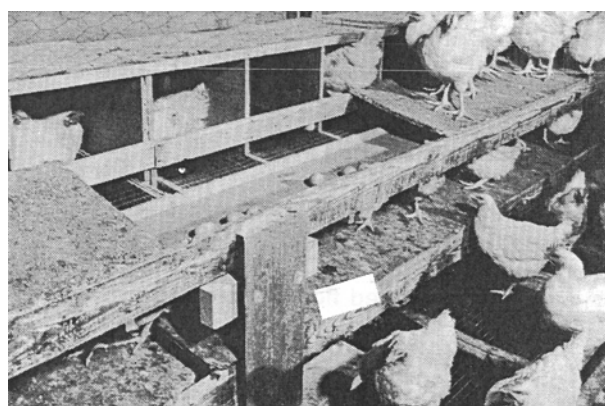

Figure 13: Roll-away nestbox



Figure 14: House with wire-and-litter floor (2/3 litter)

Basic systems for keeping poultry:

a floor systems:

Within this system one can distinguish the following types:

- free range with only a shelter for the night
- poultry run with night shelter
- litter floor system
- a partly litter, partly slatted floor system:
 - 1/3 litter, 2/3 slats
 - 1/2 litter, 1/2 slats
 - 2/3 litter, 1/3 slats

b slatted floor system

The floor consists of *wire* or *wooden slats*; the space below the slats is used for collecting the bird droppings.

c battery system

Here the birds are housed *in small cages*.

Battery systems may differ by the arrangement of the rows and tiers:

- flat deck battery
- stair-step battery
- compact battery
- tier battery

General standards with regard to stocking rates per floor area (over the whole house):

Table 3:

Type of bird	Housing system	Stocking rate
Layers	poultry run litter system 2/3 litter-1/3 slats 1/2 litter-1/2 slats 1/3 litter-2/3 slats fully slatted floor battery: ➤ flat deck ➤ stair-step ➤ compact ➤ tier	about 25 m ² /bird 4-5 birds/m ² 5-6 birds/m ² 6-7 birds/m ² 7-8 birds/m ² 8-10 birds/m ² 8-10 birds/m ² 10-12 birds/m ² 15-20 birds/m ² 18-25 birds/m ²
Rearing	combination litter/slats fully slatted floor batteries litter system	5-8 birds/m ² 7-10 birds/m ² 10-15 birds/m ² 15-20 birds/m ²
Broilers	fully slatted floor	10-20 birds/m ² 10-20 birds/m ²
Broiler parent stock	combination litter/slats	4-5 birds/m ²

2.2 Discussion of housing systems

Free range

Simple and cheap, but:

- very little supervision is possible on egg production and the hens may hide the eggs
- the chickens scavenge (herbage, seeds, insects) and may damage cultivated plants (crops)
- usually heavy losses due to diseases, predators, traffic and theft.

Poultry run

This is a semi-intensive system, with the chickens confined in a wired-in run. There is a small house attached in which the chickens can be locked up at night.

The owner provides most, if not all, of the feed, water etc.

Advantages:

- feeding costs can be reduced by about 20% if the run is well managed, with a good growth of grass (requires moving to fresh ground regularly)
- exercise and outdoor life produce a tough but tasteful chicken that some people prefer over a house-produced chicken

Problems:

In areas with a long rainy season it is very difficult to keep the run mud-free.

If one does not frequently move the birds from one run to another (a fresh one), there may be problems with worms (intestines).

And other birds may enter the run and spread diseases.

In general, the free range and the poultry run systems do not require heavy investments, but both are less suitable for commercial chicken production.

Litter system

The floor is covered with 5 to 10 cm bedding material, which absorbs moisture from the droppings.

Good litter material absorbs relatively much moisture, is free of moulds, is cheap and is continuously available. Good litter materials are:

- wood shavings
- chopped straw or hay
- rice husks

- groundnut hulls
- and other materials

Well managed litter is dry and friable and almost free of ammonia. It is difficult to shape it into a ball, by hand (practical test).

Wet litter is ideal for the growth of *Aspergillus* (causing aspergillosis) and coccidia (coccidiosis). Poor litter quality produces a lot of ammonia, causes diseases and poor performance.

To keep the litter dry, to prevent it from 'caking', the litter may be turned with a rake once in a while. Wet spots (e.g. around drinkers) should be attended to immediately. Sometimes agricultural lime is applied to litter that is somewhat damp. Litter management is especially difficult in humid climates.

Slatted floor

Here the floor of the house is made of *wire* or *wooden slats*. Special attention should be paid to the construction of the floor-supporting structure.

The floor should be constructed in sections so that it can be removed to clean out the manure.

A slatted floor is expensive but the problems with wet litter are avoided.

Slatted floor systems are not recommended for breeders and may cause breast blisters in broilers.

Combination litter/slatted floor

The dropping pit can be situated in the middle or along the long side(s) of the house.

Most of the droppings are now collected in the dropping pit under the slats or the wire. This means that it is relatively easy to maintain the litter in good condition.

And the birds still have the opportunity to scratch and take a dust bath.

Battery system

The birds are confined to *small cages*, from 1 to 5 layers per cage. Cage density should not be too high; especially in hot climates not less than 500 cm² floor area should be provided. In the European Union countries floor area is going to be increased to 800 cm² per bird (obligatory from the year 2000; proposal).

The cages may be arranged in different ways:

Flat deck

Only one tier and this means only a small number of birds per unit of house floor area; this is the main reason why the flat deck is not popular anymore.

Stair-step

The two middle rows are fixed together and raised above the side rows. The droppings fall directly into the dropping pit. Housing density cannot be much higher than in a flat deck system.

This system is very popular in open-sided houses in tropical countries because it allows proper ventilation without (extra) fans.

Compact

Between the different tiers in a stair-step formation are dropping boards or plates to collect the manure, so that cages can be arranged in a more compact way.

The manure has to be removed (by hand or automatically) from these boards into the dropping pit.

Tier battery

The cages are arranged in the tiers (2-5).

Between the different tiers there is a manure belt to collect the manure and move it to a pit in the front or at the back of the house.

See illustrations.

Generally speaking, the advantages of the battery system are the following:

- highest stocking rate
- less risk of disease, because the birds are not in contact with droppings
- higher egg weight
- lower feed intake (about 3-4%) and better feed conversion rate
- labour saving
- easier supervision/culling/selection
- no floor eggs
- no broody hens

But:

- relatively high initial investment costs per bird
- the system is not flexible
- technical problems especially if maintenance is not up to standard
- percentage second class eggs is higher
- especially ventilation is likely to require more attention and control
- debeaking and light intensity control are necessary

Chickens cannot be transferred from cages to any other housing system. Nor from fully slatted to partly slatted floors or all-litter floors.

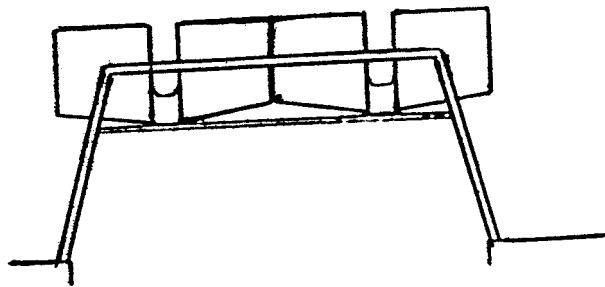

Figure 15: Flat deck battery, 8-10 birds/m² (of floor area)

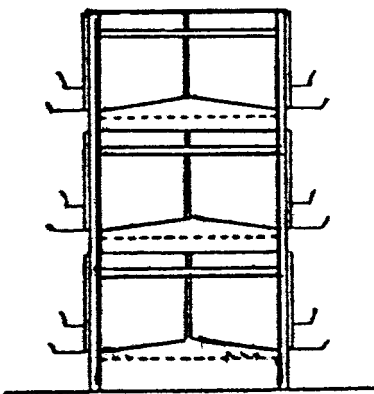

Figure 16: Tier battery, 18-25 birds/m²

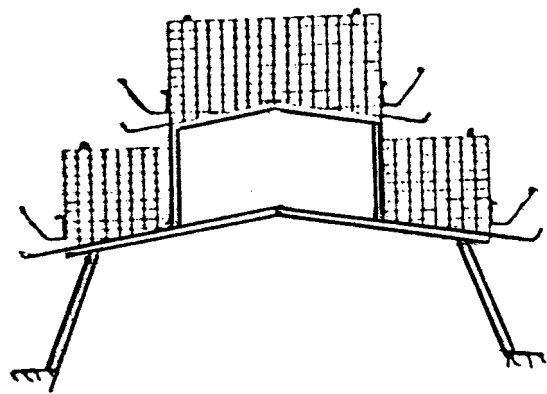

Figure 17: Stair step battery, 10-12 birds/m²

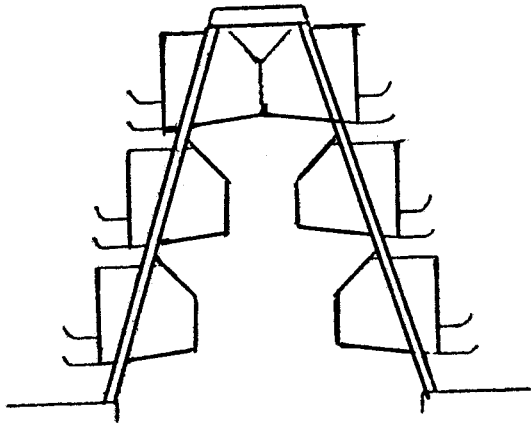

Figure 18: Pyramid battery, 15-20 birds/m²

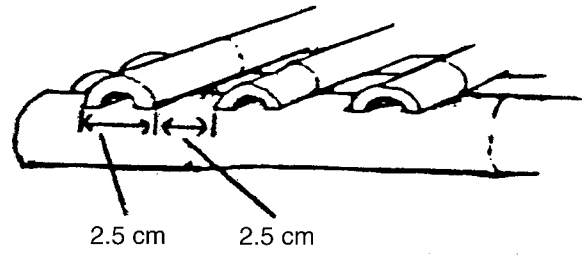

Figure 19: Bamboo slats

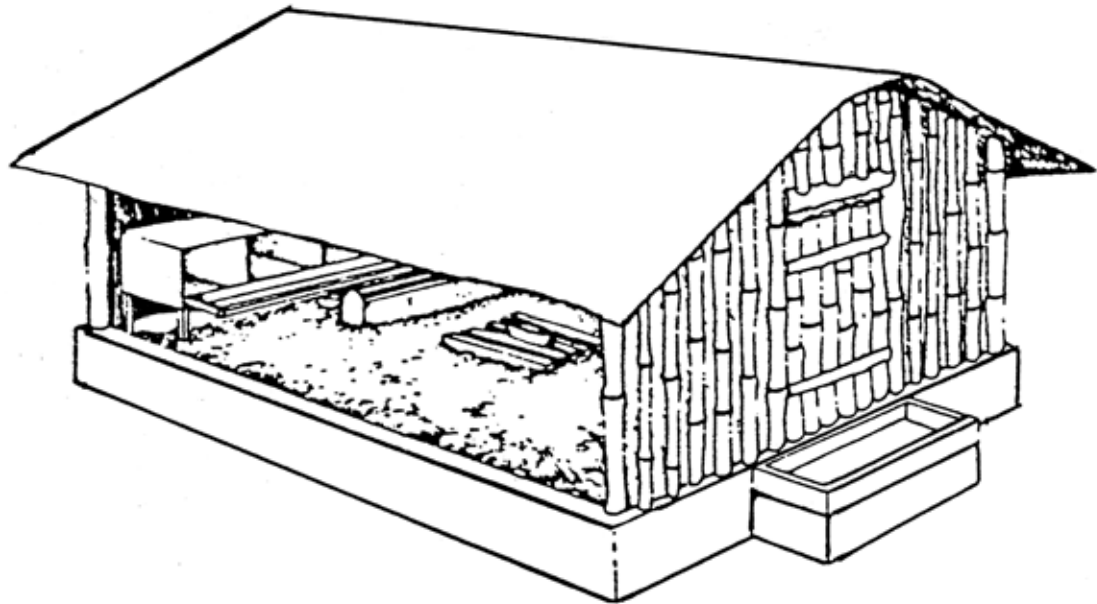

Figure 20: Example of chicken house in the tropics

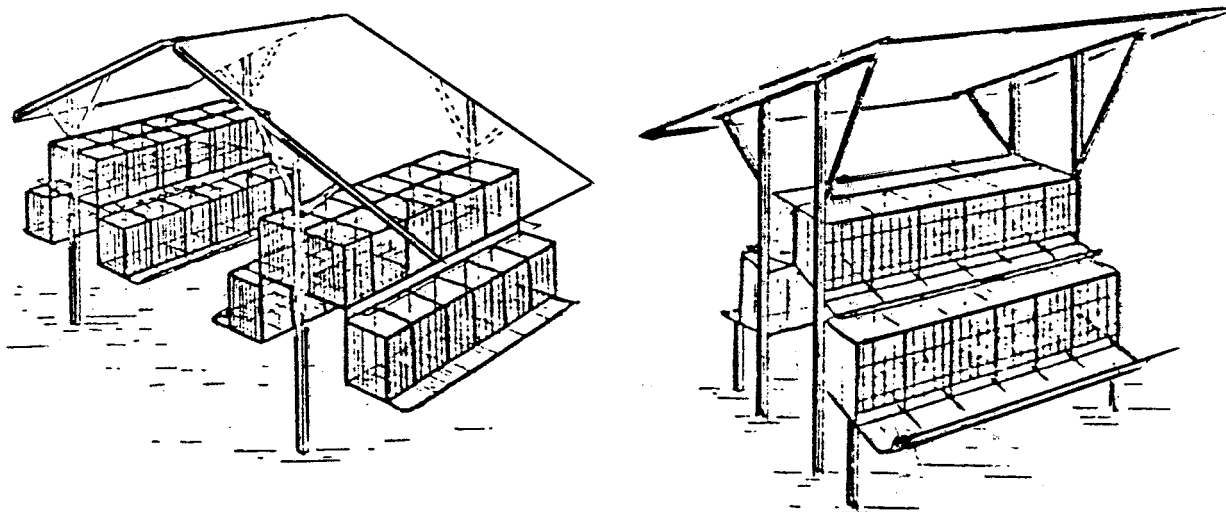

Figure 21: Stair step system

2.3 Construction of a non-climatized chicken house

- 1 The *materials* which are used should be:
 - durable (lasting)
 - easy to handle and easy to repair if damaged
 - readily available and as cheap as possible

Building and repairs should preferably be carried out by the poultry farm itself in order to reduce costs.

- 2 The *width* of the house should generally not exceed 9 metres when only natural ventilation is used. The length depends on the number of chickens that is going to be kept and the available building space.
The *height* of the poultry house should not be less than 2 metres anywhere in order to make the house easily accessible everywhere (without stooping). Moreover it provides more volume to the house resulting in a better air quality.
- 3 The *floor* should be made of concrete (this is the ideal floor for a chicken house because it is easy to clean) or be filled with 50 cm (sharp) sand. Wire netting should be placed under and around a floor made of sand in order to keep rats and other predators out.
- 4 In hot climates at least 3 sides *should be open* (wire netting!) in order to have enough fresh air (ventilation) for the chickens.
By means of boards or mats the sides may be temporarily and partially closed when there are young chickens inside.
- 5 The *roof* should protect the chickens against direct sunlight and rain and for that reason it should extend the walls for about 50 cm beyond the wall. The roof may be ridged or slope to one side. If the roof is ridged, this ridge should be *open* to permit heat to escape (the natural ventilation is improved by the stack effect).
- 6 The chickens should be protected against too much heat during the day. For that purpose a heat insulating layer may be installed under the roof. However, this is relatively expensive and generally not very effective.

Materials which insulate rather well are cotton fibre board, PVC and certain plant materials such as palm leaves.

The canopy of tall trees can also cast shade on the roof.

- 7 Besides space for the birds, every (relatively large) chicken house should have
- an *entrance room*, where people can change footwear and clothing and wash their hands before they go to the birds. Disinfection must take place here;
 - a *feedstore* with enough space for the feed that is needed for the birds for one or two weeks; dryness should be ensured as feed spoils rapidly in moist conditions.

2.4 Conditions in the chicken house (the ‘climate’)

Factors which influence the climate in a chicken house are:

- temperature
- relative humidity
- composition of the air in the house (air quality)
- interior air circulation and speed
- the volume of the house
- light (daylight and artificial light)
- dust, flies

The climate in a chicken house has a great influence on the health and production level of the chickens. Especially young and highly productive birds are sensitive in this respect.

It is not always easy, or it may not even be possible, to influence the climate in a chicken house in the tropics, but three things are very important:

- 1 proper insulation of the roof (in closed chicken houses)
- 2 good ventilation is of utmost importance
- 3 proper hygiene

An ambient temperature between 20 and 25 °C fits the laying hen best. When layers are exposed to (much) higher temperatures we can expect the following to happen:

- the birds are looking for cooler places (e.g. cement floor)
- there is less activity
- the birds start panting and spreading their wings in order to increase their body surface
- water consumption increases and feed intake drops
- egg production drops, egg weight decreases
- shell quality and strength decrease
- lower fertility and lower hatchability of the eggs

Optimal temperatures are:

- chicks/pullets/broilers 30-20 °C (decreasing with age)
- layers 20-25 °C

Environmental control in the (sub)tropics

In order to restrict the negative effects of too much heat, certain measures can be taken:

- prevent solar radiation in and on the house
- keep the heat production of the birds as low as possible
- promote heat losses by the birds
- maintain feed intake

Solar radiation (sunshine) can be minimized by an east-west orientation of the house. The roof should be relatively high, with a large overhang (about 1 metre).

Trees may provide shade. Grass or other plants covering the surroundings of the house will reduce ground radiation.

Heat production by the birds can be kept low by keeping the birds quiet during daytime (period of greatest heat load).

The greatest effect, however, can be expected from *air movement*. In open houses this can be obtained by installing (large) fans. In relatively dry, hot climates evaporative cooling (pad and fan cooling) can be applied, in closed houses.

Air must be allowed to move freely through the chicken house; high air speeds up to about 2.5 m/s during hot periods of the day are not harmful but have a beneficial effect.

Feed consumption should not drop. A commonly taken measure is to make the day longer by providing artificial light in the morning and/or in the evening. The birds rest during daytime and eat when the environment is relatively cool. But a conflicting situation may arise if the method is applied during the rearing period of pullets (see under 2.5).

Other practical measures to reduce the heat load are:

- whitewashing of the roof to reflect direct solar radiation
- wetting the roof (if water is freely available)
- providing cooled drinking water to the birds (temperature lower than the ambient temperature)
- applying slats which will allow free air movement under the birds
- reducing litter depth in order to eliminate heat caused by fermentation in the litter.

2.5 Lighting chicken houses

Reproduction in birds (including poultry) is influenced by light. Light affects:

- the start of sexual activities (the laying of eggs)
- the start of egg laying after a rest period

However, by means of selection and by changes in the environment, the present hen has extended her period of egg production from a relative short period in spring (temperate climates) to a period almost the whole year round.

Still, the influence of light on the release of hormones produced by certain glands is definitely there.

Light also has a physiological effect: it stimulates activity, the birds eat more and this affects body-weight and egg production.

Lighting in the rearing period

The rearing period is very important in a hen's life.

General effects of lighting in the rearing period are:

- long days in the rearing period lead to earlier maturity than short days; the difference is 7-10 days in general
- increasing daylengths stimulate sexual maturation of the young, growing birds; short days and decreasing daylengths have the opposite effect
- over 14 hours, changes in daylength have less effect
- sensitivity to changes in daylength varies with the breed or line of the hens

It is interesting to know that hens come into lay even without any light. Apparently the maturation process is autonomous. Daylength only influences the speed of this process.

In lightproof houses (closed housing) it is possible to manipulate lighting at will. In open housing the natural daylength cannot be shortened; but it can be made longer by artificial lighting. Costs and benefits have to be considered and should play a decisive role.

Lighting in the laying period

As soon as hens come into lay egg production is stimulated by increasing daylengths. Hens in lay should never be exposed to a decreasing daylength.

Tests have shown that hens which start production late, will not produce better towards the end of the laying period. The heavier egg weight will not be sufficient to produce the same amount of eggs (kg) as early starters do. So layers of which the daylength has been suppressed during the rearing period need a stimulus to reach top production within the normal time, mostly between 18-20 weeks of age. In modern hybrids even earlier. A weekly increment of 15 minutes will do.

Tests throughout the world have shown that:

- Layers which start production with increasing daylength (so, at a relatively young age) will produce many small eggs and 'prolapse' (i.e. end part of the bowel slipping out of place) is quite common.
- Layers which start production with decreasing daylength (so, at a relatively old age) need a rather strong light stimulus in order to reach a sufficiently high production peak. The loss in eggs in the beginning is the cause of a lower production (kg).

The best is 'in between', i.e. rearing with relatively short daylengths or, at any rate, not with increasing daylength, so that the birds start producing in time, but not at extremely young age. The birds do not need long days to reach a good peak production. In this way there is the possibility to stimulate egg production in a later stage.

The 'in between' practice is generally used and gives excellent results if properly applied.

Implementation in a completely dark house is not difficult at all. However, in an open house it has to be combined with daylight (changing perhaps) and this may give problems.

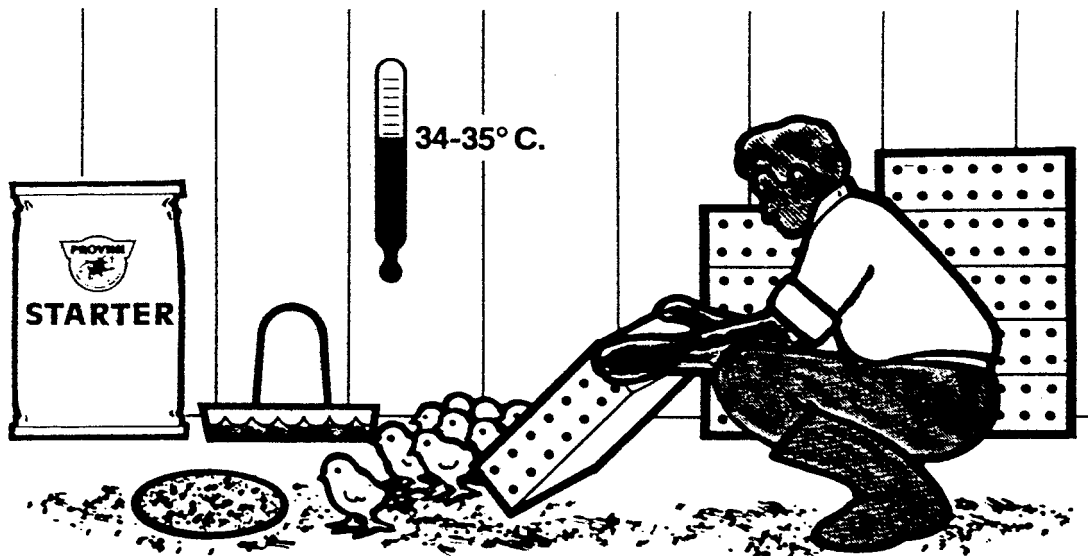
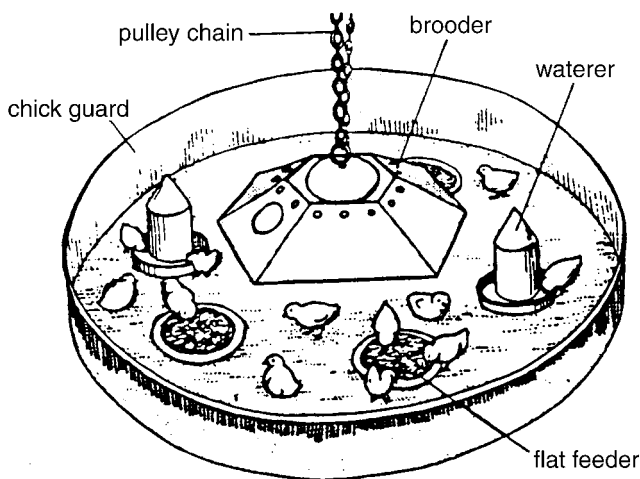

Figure 22: Receiving one day old chicks



- Max. 500 chickens per brooder
- 75 chickens per fount
- 100 chickens per feed plate, or 50 chickens per egg tray
- Height of guard min. 45 cm
- Density at day 1, 40-50 chickens per square metre; remember to expand the guard a little every day

Figure 23: Chicks in a brooder house, note cardboard chick guard

2.6 Feeding equipment

Feed wastage in chicken farming should be kept at a minimum. For that reason it is important to pay attention to the following:

- the feeding equipment should be suitable for the type of chicken that is kept; e.g. broilers need another feeder than broiler parent stock
- the feed level in the feeders should be kept low. Feed should be given relatively often but in small amounts
- every feeder should have a rim provided with a lip
- the height of the feeder, that is to say the distance from the rim to the floor (litter or slats). In general the lower the feeder, the better. But on litter floors the feeders should be raised to prevent litter from entering the feeders

Generally speaking, feeding equipment should comply with the following conditions:

- 1 it should be durable (long-lasting)
- 2 it should be possible to regulate the feed level in the feeder
- 3 it should be possible to adjust the height of the feeder without difficulty
- 4 the cleaning should be easy

Which type of feeding equipment should be chosen for a particular chicken farm depends on the size of the farm and the cost of the equipment in relation to labour costs. Of course, availability is another factor.

In a general way the market offers:

Special equipment for feeding day-old chicks

During the first few days of the brooding period one can use:

- the base of the cardboard box in which the chicks have been delivered (hygiene permitting)
- egg trays
- specially made cardboard lids
- specially made chicken feed trays

The chicks should gradually be weaned away from this type of feeders. After 3 to 4 days begin removing some feeders each day and have them replaced by normal handfilling (or automatic) feeders. After 6 to 7 days discontinue feeding on lids etc. entirely, to save labour and to avoid feed wastage!

Straight feed troughs

This type of feeder can be made locally, almost everywhere, from wood, bamboo, plastic or metal sheeting. The main part is the feed container of which the brim may be wider than the base. The rim of the long sides is curved into a 'lip' in order to restrict feed wastage. A spinner on the top gives sufficient access to feed but prevents wastage and prevents the feed from becoming soiled.

Round (hanging) feeders

These feeders are made from plastic or metal and have a circular pan into which feed flows from the container. The feed level in the pan is adjustable by moving the container up and down, but in practice the feed level in this type of feeder is often too high.

Semi-automatic round feeders

This feeder also has a circular pan, with a cone fixed to its centre. A barrel (cylinder) is placed above the pan by means of an axle. The distance between the base of the barrel and the base of the pan is adjustable, to obtain a proper feed level in the pan. This feeder can be filled once every 2-3 days. Just by turning the barrel the feed will flow into the pan.

Chain-feeding systems (flat)

Here there are one or more storage hoppers and the feed is delivered by a flat chain running in the feed trough. The speed of the chain is approximately 4-6 metres/minute. Sometimes the speed is adjustable. If a restricted feeding programme is in operation (B.P.S.) it is recommended to increase the speed up to 12 metres/minute since the feed should be distributed quickly over the whole house, in order to keep the flock uniform.

Different trough designs are necessary for broilers, breeders or layers. There may be one or more feed circuits. The right feed level is about 1 cm above the links of the chain.

The main parts of the feed-chain system are:

- hopper
- drive unit
- troughs (different designs)
- leg assembly; the whole system can be adjusted as the birds grow
- chain; connection/disconnection possible everywhere
- corners
- rise or fall elbows; e.g. one feed line is used in the litter part and the other in the slatted part of the house
- feed cleaner which removes dirt and debris from the troughs as the chain returns to the hopper
- electric time switch: how often per day and for how long should the system function
- a device to maintain the right tension in the chain.

For easy cleaning of the house, both the hopper and the troughs may be suspended from the ceiling of the house.

Pan-feeding systems

Here again the 'heart' of the system is the storage hopper. The feed is distributed to the pans by conveyors, such as augers, cable and discs or chain-links which are running in tubes. The conveyor pipe may be mounted directly over the feed pans or under the ceiling, in which case the feed flows into the pans through two or three 'down tubes'. Or the conveyor may be mounted in the base of a V-shaped trough.

In recent years there is a move away from flat-chain feeders mainly in favour of pan feeders with adjacent tube conveyors. It is said that pan feeders are more efficient in terms of growth rate and feed

intake leading to a better feed conversion rate of broilers. But the investment costs of a feed pan system are much higher.

For both systems it is of utmost importance that the feed level is kept as low as possible and that feed is delivered as frequently as necessary, to avoid feed wastage.

Feed hopper-trough systems

These systems are used universally with battery cages. Feed is delivered to the trough either by moving the hopper along the battery or by an auger system. With a hopper moving along a battery it is very difficult to maintain an even and low feed level in the trough. Locally this results in high feed levels and hence feed wastage. Hopper-trough systems modified by the addition of fixed or flexible grids/shoes can reduce feed wastage.

Table 4: Standards for feeders (minimum figures)

	Rearing		Broiler	Layer	B.P.S.
	starter 0-8 weeks	grower 8-18 weeks			
round feeder Ø 40 cm					
➤ cm/bird	1.5	3	1.5	4	6
➤ birds/feeder	80	40	80	30	20
straight feeder					
➤ cm/bird	4	8	4	10	15
➤ birds/metre	50	25	50	20	12-13

B.P.S. = Broiler Parent Stock

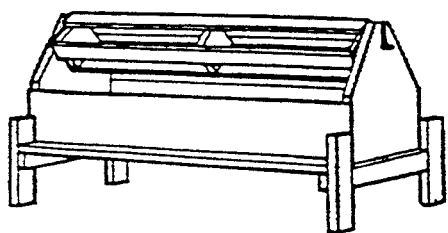

the swivel crosspiece prevents roosting

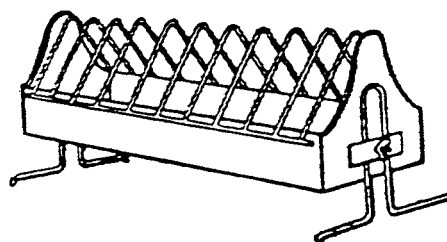

this feeder can be raised or lowered to fit different sizes of birds

Figure 24: Straight feed troughs

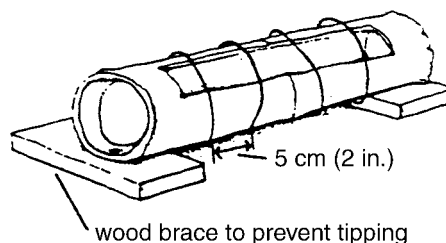
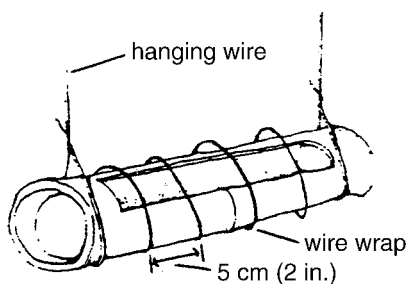

Figure 25: Bamboo feeders

Bamboo can be used for inexpensive feeders. To keep the birds out, use a spinner, or tightly wrap the feeder with wire, as shown.

Dimensions depend upon the number and size of the birds.

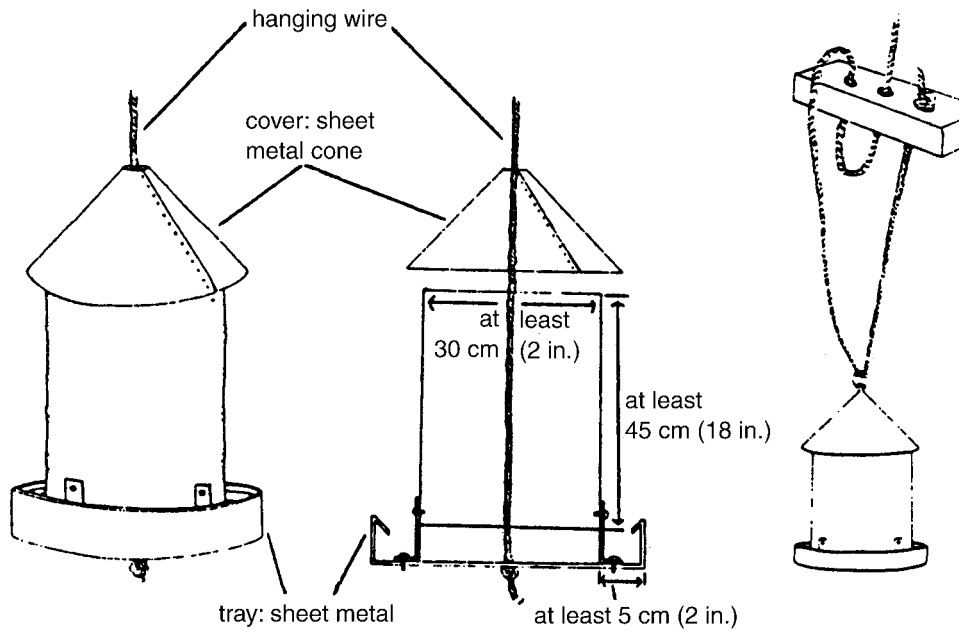
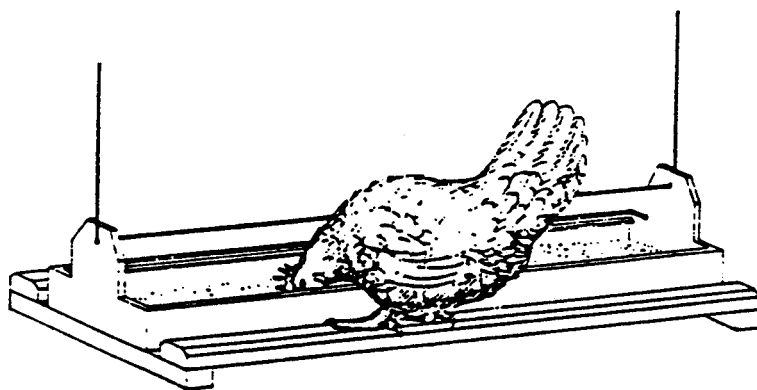

Figure 26: Hanging feeders

Hanging feeders have several advantages, including: rats have difficulty getting into them; they continuously supply feed at the proper height; its is easy to adjust their height. They can be made from large tin cans, or from sheet metal



Trough 120 cm long providing double-sided feeding
Lips along sides reduce food wastage

Base and total height, 25 cm
Height of sides, 12 cm
Perch from trough, 10 cm

Figure 27: Hanging feed trough

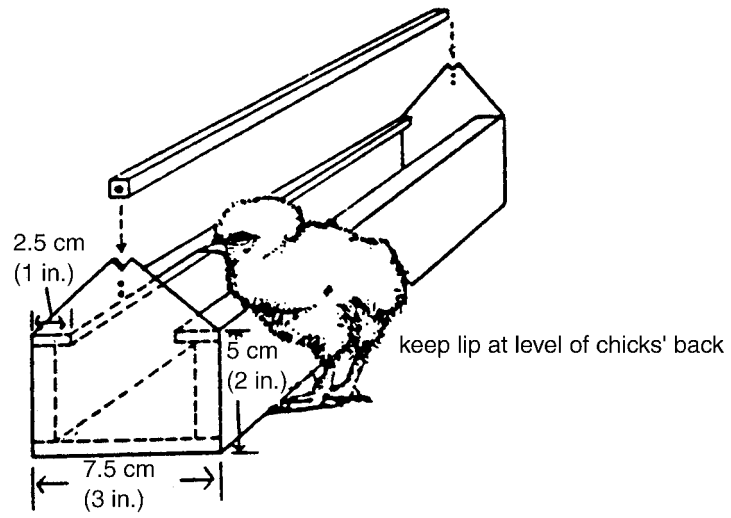

Figure 28: Chick-size feeder

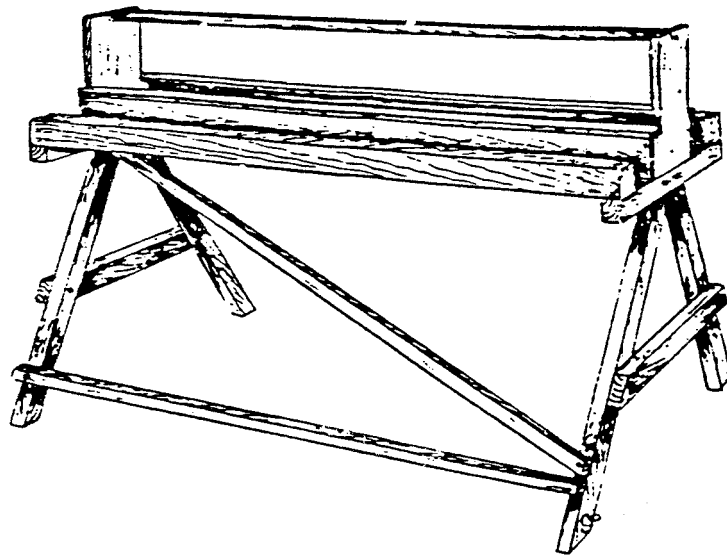

Figure 29: Deep-litter feeding trough

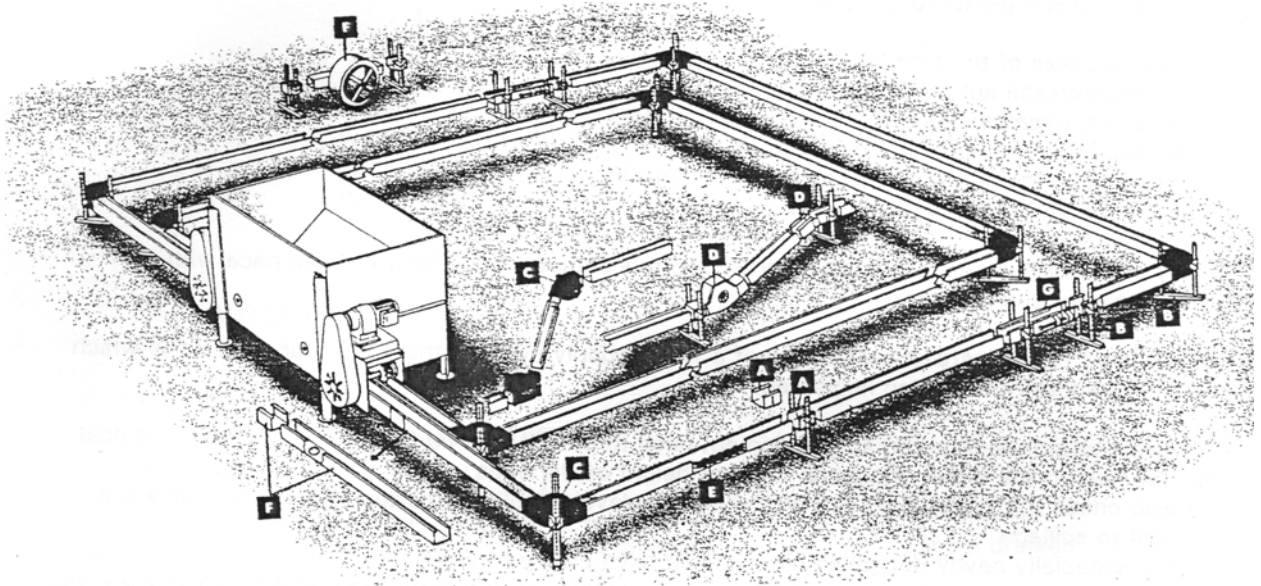

Figure 30: Automatic chain feeding

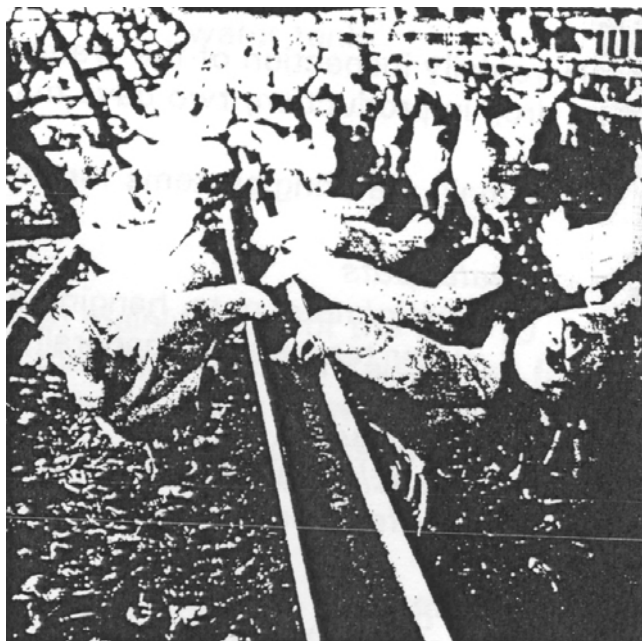

Figure 31:

2.7 Water equipment

It is rather difficult to decide which type of watering equipment to use for one's farm, because there are several points to consider:

- type and size of the farm
- automatic/semi-automatic/manual system
- is skilled, experienced and reliable labour available?
- availability of good quality drinking water
- prices of different types of equipment; availability
- funds which are available

Many different systems are on the market and it is sometimes difficult to keep pace with developments in this sector.

With regard to the installation and use of a water supply system, there are four basic rules which are very important but often neglected:

- 1 semi-automatic or automatic equipment need to be checked *daily*
- 2 *the height*: the water should be on back-height of the birds
also check the water level in the drinkers; the level should not be too high because this will lead to spillage
but especially newly debeaked birds should have plenty of water
- 3 make an accurate calculation of the number of drinkers that is required; it is better to have too many than too few!
- 4 *clean drinkers daily* in order to avoid contamination with bacteria and fungi

Water on batteries

Here daily inspection of the watering equipment is essential. One day without water already causes a drop in production, two days may lead to a production loss of 2-3 weeks and possibly a moult.

The main watering systems for battery cages are:

- *water pots*
 - plastic/metal pots, hanging at the front side of the cages
 - water temperature generally high
- *water troughs*
 - plastic/metal/bamboo over the full length of the battery
 - in V-form or in U-form
- *nipples*
 - least troublesome technically
 - limited to battery cages
 - nipples keep the water clean and are laboursaving

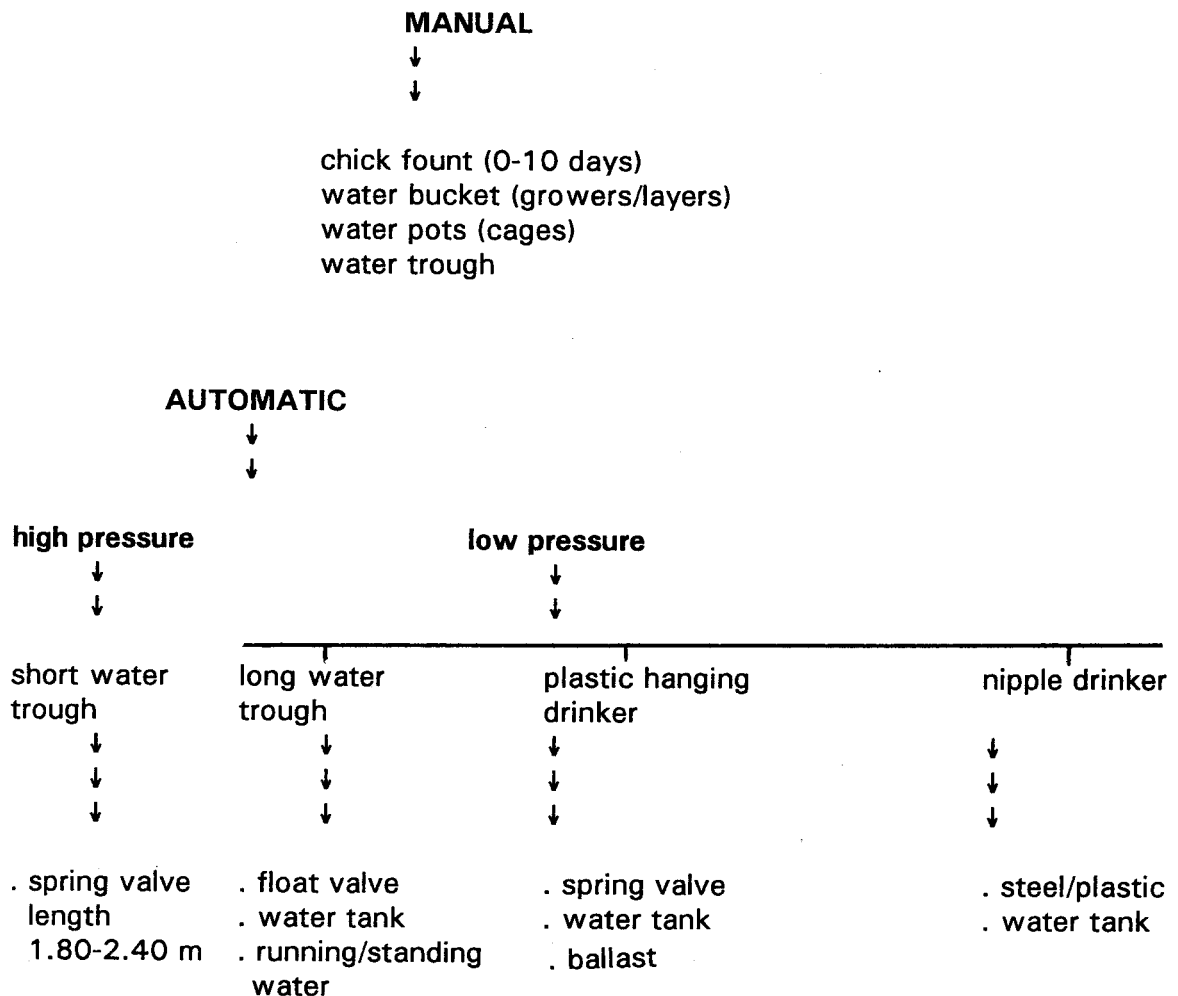

Figure 32: Types of watering equipment (schematically)

Chick fount

This is a rather small drinker, especially made for day-old chicks and mainly used for the first 10 days of a chicken's life. Plastic or metal. There are several types; the bigger ones are also used for layers. With hanging types the height adjustment is very important (avoid waste of water and wet litter). The rim of the drinker should be at back-height of the chicken. A special form is the bottle + bowl type.

Bucket

This is one of the simplest drinkers: a container with water. The height should be 12 to 15 cm. Problem is that quite some water is wasted, because of the chickens standing in the drinker (suggestion: lay a brick in the bucket). After some time the water becomes soiled and it is difficult to keep the litter in good form.

Water pots

This is the 'miniature' form of the water bucket. Made of plastic and used on bamboo or metal battery cages. Requires a lot of attention!

Water trough

Filled manually, but otherwise just like the automatic low pressure long water trough (see below).

Advantages of *manual* drinking systems:

- cheap

- various materials are suitable: plastic, metal, bamboo, glass
- little maintenance required

but:

- often poor litter quality
- water temperature quite high
- labour intensive (which is not always a problem)

Short water trough

Connection with mains (high pressure). The spring valve is the crucial part of the system. It has a single or double shutter. As this drinker hangs more or less freely, it is quite easy for the chickens to throw it off. This causes a tremendous waste of water when a single shutter is used. A double shutter prevents this from happening.

As the drinker has a length of 1.80 to 2.40 metres, many connecting points are necessary which makes the tubing system rather expensive.

From a management point of view it is important to check the water level in the troughs regularly. A way to keep the water clean, without losing water and feed, is to have the birds empty the troughs daily (but be careful that the birds are not too long without water!)

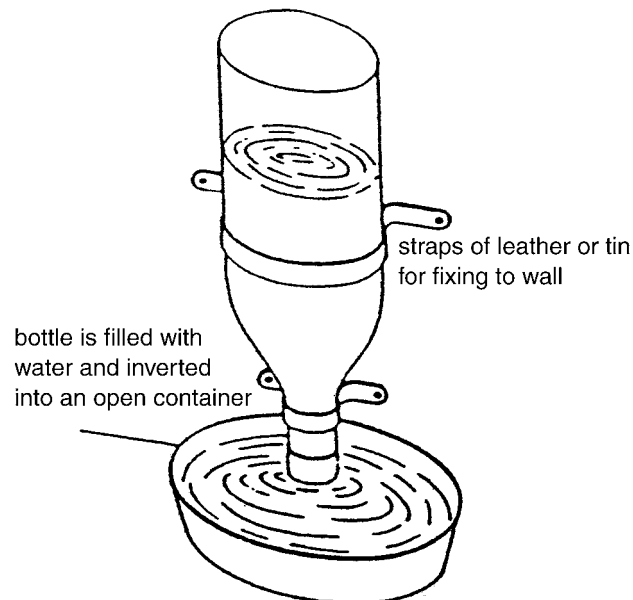

Figure 33:

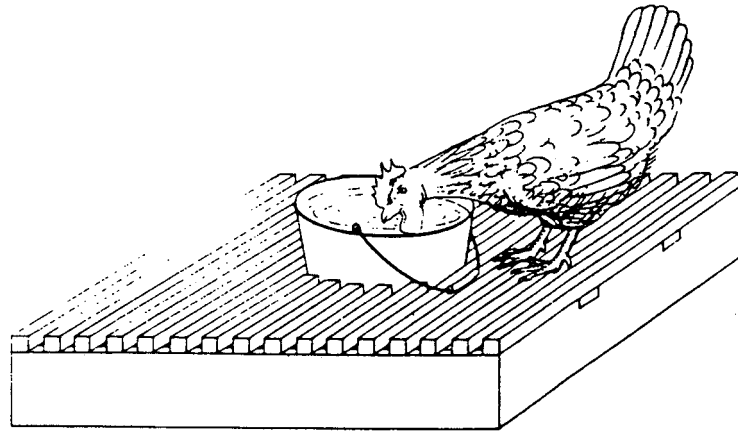

Figure 34: Bucket-type water container on slatted platform

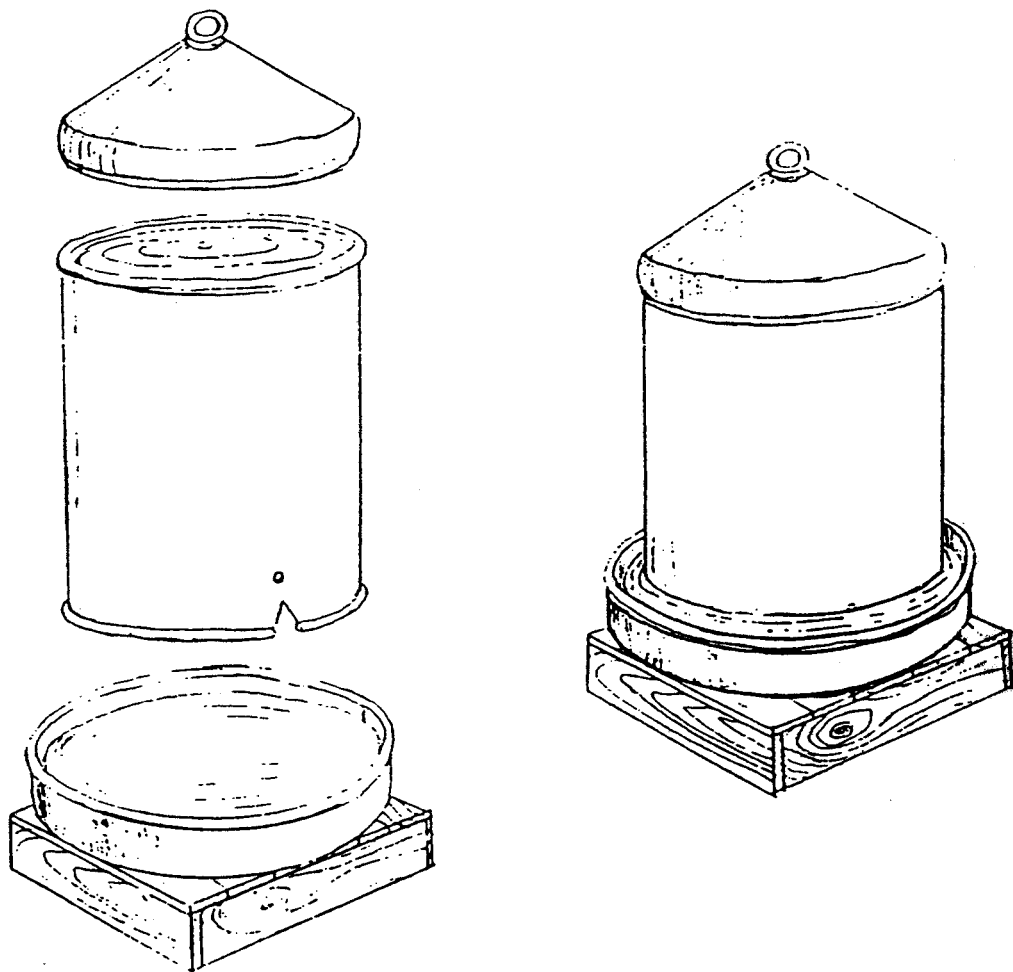

Figure 35: Drinking fountain tin can type

To sum up, advantages:

- good distribution of drinkers is possible
- easy to handle when the house is cleaned

But:

- many connecting points & more leaking likely
- spring valves sensitive to impurities in the water & no water or water overflowing

➤ drinkers easily thrown off by the birds & wastage, poor litter, wet manure

Long water trough

Here water is supplied in two different ways:

a standing water

There is an adjustable float valve. When the water level in the trough drops, the float opens automatically. At the other end of the trough there is an overflow in case something goes wrong.

b running water

The water flow never stops and is constant; it does not react on an increased water consumption of the birds. This type of drinker is used for all types of chickens, also on batteries. Different materials can be used:

V-form plastic or metal
 easy to clean by the birds

U-form metal
 much more water in the trough, at the same level; difficult to clean

O-form bamboo
 difficult to clean; trough joints difficult to seal & leakage

Materials

plastic: very suitable for batteries, because it is not heavy;
 sturdy, strong;
 support every two metres
 trough parts not longer than four metres and coupled with expansion coupling

metal: galvanized iron, aluminium, stainless steel (only galvanized iron is interesting because of its price);
 parts not too long (approx. 4 m) and couplings sealed with kit;
 paint the inside for longer life

bamboo: if too small, the birds will not drink!
 treat the inside for longer life

Because long water troughs can be really long (100 metres!) they should be strictly level otherwise there is a problem with the water. The most stable situation is suspending the trough from the roof (rafters or trusses) with chain for metal cables, not too far from each other (about 2.5 metres).

To prevent the chickens from sitting/resting on top of the trough, very often a wire is fixed approx. 7.5-10 cm above the trough.

With the *standing* water system, having a separate water tank is strongly recommended, for two reasons:

- 1 to eliminate pressure fluctuations (if these occur)
- 2 the tank can be used for mixing drugs with the drinking water

but the consequence is a higher water temperature.

With a *running* water system, water comes straight from the mains and is therefore cooler (if the water passes underground).

In general, when there is a reliable mains, with relatively cool water, the running system is to be preferred.

Cleaning a long trough is relatively easy. There are two ways to do it:

- Clean the trough at least once every two days, with a sponge, to remove water and feed remains.
- Let the birds do it. Shut off the water flow every day for a short time. The chickens have then the opportunity to finish the water and eat the feed remains inside the trough (birds like wet feed very much but only when it is fresh). Make sure that the birds are not without water for too long. By means of a time switch and a solenoid valve the process can be made automatic.

Plastic hanging drinker

The plastic hanging drinker has a valve built in the drinker body. There are two main types: with or without ballast tank on the drinker. The one without ballast, however, is very unstable (water losses!) and for that reason most hanging drinkers are fitted with a ballast tank (filled with water, sand or pebbles).

The drinker itself is made of plastic (excluding two springs inside the valve unit). It has a bell-trough and a valve unit. The bell-trough may have one or two rims. Nowadays the one with two rims is hardly used any more because it is difficult to clean. The one-rim type may be dangerous for day-old chicks (drowning!) because of its relatively large size.

The ballast tank should be of good quality otherwise the drinker may easily start leaking. The weight in the ballast tank is normally about 1.5 kg (= 1.5 litre of water).

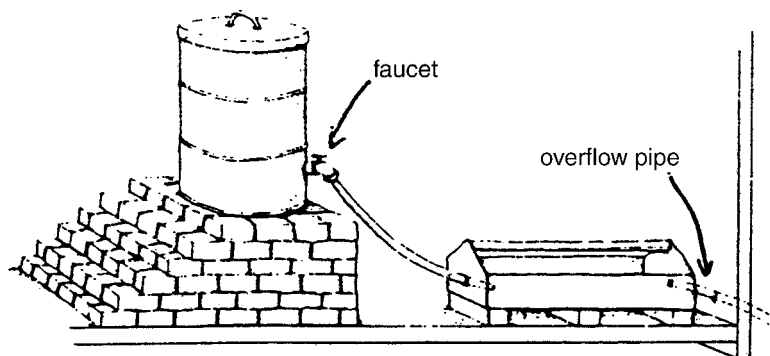

Figure 36: Automatic watering system

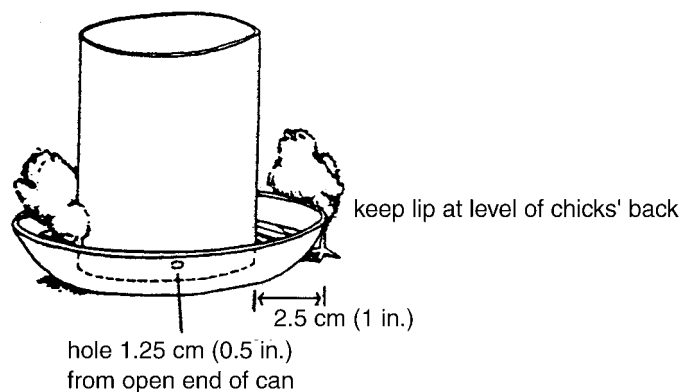

Figure 37: Chick-size waterer

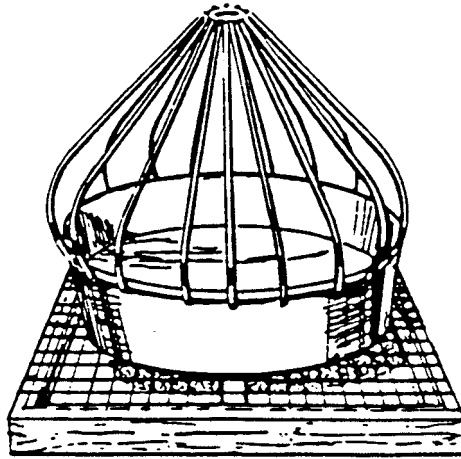

Figure 38: A simple pan waterer can be fitted with a wire cage to keep the chickens out

The *valve* is the most important part of the drinker. There are two possibilities:

- 1 the water level in the bell-trough is regulated by the weight of the water in the trough plus the weight of the ballast. If the weight of the ballast diminishes (trough water evaporation), the valve reacts by putting more water in the bell-trough, to point of overflowing (wet litter and manure!);
- 2 the weight of the ballast does not act on the valve. Only the weight of the water in the bell-trough is decisive for the functioning of the valve.

The *hanging drinker system* is a low-pressure system. There is a water tank (connected with mains or otherwise filled with water) and from the tank the water flows through the main pipe to the drinkers. The water tubes of the drinkers are connected with the main pipe by means of T-piece or saddle connectors. The pressure on the valves must be 0.3-0.5 at. corresponding with a difference in height between the valves and the water level in the tank of 3-5 metres (every metre is 0.1 at. pressure difference).

The end of the main pipe must be open, to allow possible air bubbles in the system to escape without troubling the water supply to the birds.

The positive points of this hanging drinker system are:

- drinkers can be properly distributed all over the house
- the system can be used by day-old chicks as well as by layers
- the water level in the bell-troughs can be adjusted with precision
- lower pressure system
- rather stable if ballast tank is used

But:

- water is not fresh
- bell-troughs with double rims are difficult to clean
- sometimes there is air in the system & dry bell-troughs!
- high investment costs

Nipple drinkers

Nipple drinkers are mainly used in laying cages. In temperate climates almost 100% of the batteries are fitted with nipple drinkers. For hot climates the advantages of nipple drinkers are less distinct.

A nipple drinker in itself is a very simple piece of equipment. Although there are several types, all nipples have three main parts, namely nipple body, nipple pin and nipple top dolly.

The *body* can be made entirely from stainless steel or the inner body only. Nowadays the colour of the body is always red as it is believed that the red colour has a certain attraction for the birds.

The *nipple pin* is the important part because it must be lifted by the birds, to open the water

supply. The weight of the pin plays an important role: too heavy, it is difficult for the birds to lift the pin; too light, the nipple may leak.

The *nipple top dolly* makes the nipple return to its closed position. Nowadays nipple drinkers have a fixed top dolly, to prevent the dolly from falling off the nipple.

The best place for the nipple drinkers is in a side wall back in the cage. This position has certain advantages:

- the eggs do not become wet by leaking water
- the feed in the trough stays dry; hens do like wet feed but it is not good for the feeder bottoms
- in each cage the hens have access to two nipples; if one nipple does not work there is always a second to use, on the other side of the cage

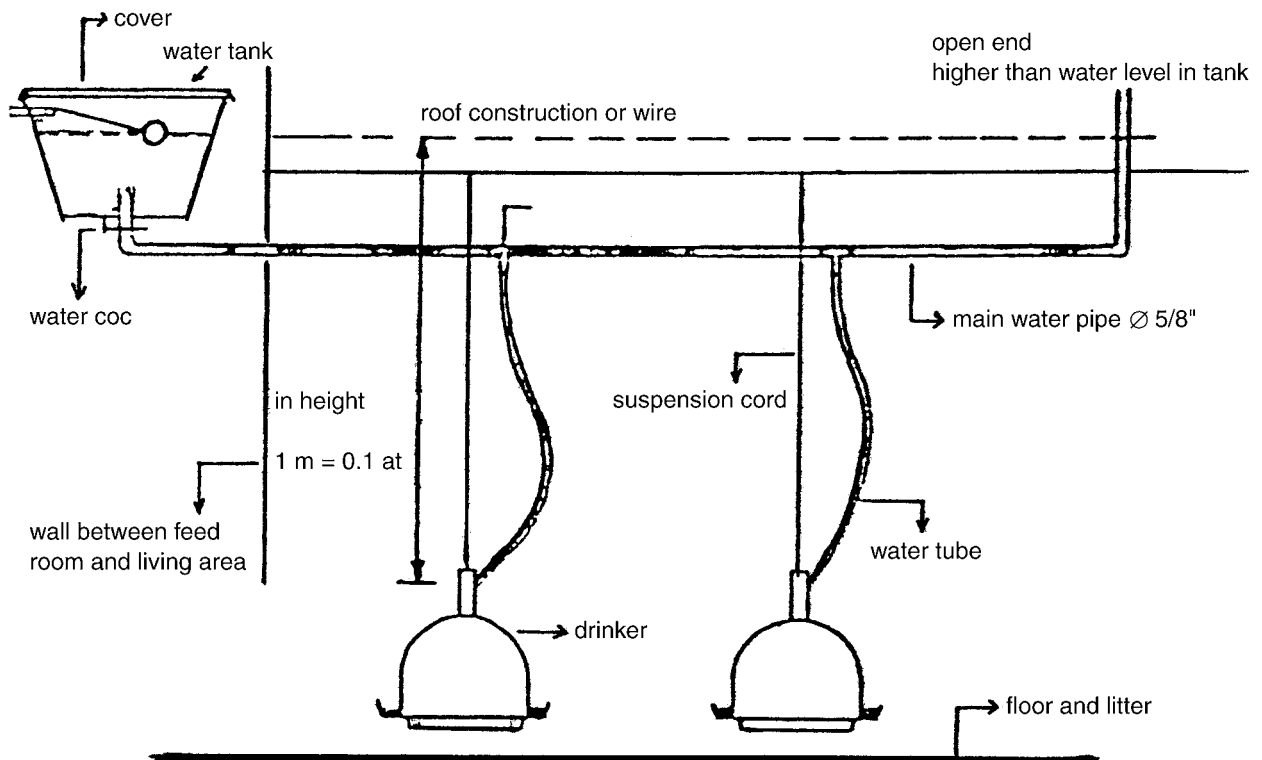

Figure 39: Hanging drinker system

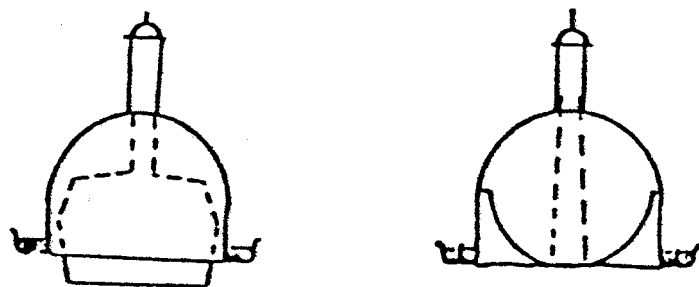

Figure 40: Bell-trough with one and two rims

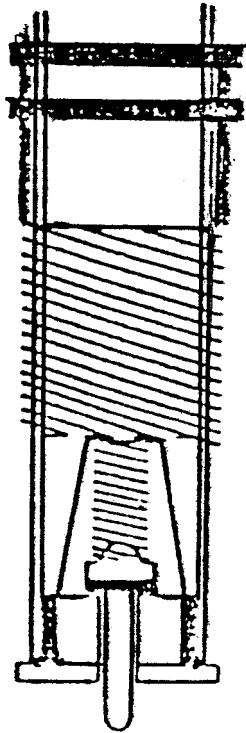

Figure 41: Valve unit of hanging drinker

The water pressure on the nipples must be very low. Under normal operation the bottom of the water tank is on the same level as the nipple water pipe. If the pressure rises, the nipple starts leaking (wet manure).

Sometimes leaking is necessary in order to avoid watering problems with newly-placed birds which have to get used to their watering system. Nipples start leaking when the water pressure is increased or/and the nipple water pipe is turned.

As with the hanging drinker, the end of the nipple water pipe should be open, above the water level in the tank.

For proper functioning of the nipple drinker system it is not only necessary to have good quality, clean drinking water and a good quality nipple, but also:

- low pressure water and this pressure must be adjustable
- pipes running straight (horizontal)
- no air bubbles in the pipe
- debeaking should be done very carefully or not at all
- high quality management

2.8 Laying nests

Laying nests are indispensable for layers that are not housed in batteries. In non-battery houses *floor eggs* are a problem all over the world. What one can do to cope with the floor egg problem:

- install and open the laying nests in time
- the nests should be easily accessible to the hens
- there should be enough laying nests for the hens
- the laying nests should be spread evenly over the house
- do not collect all the eggs in the beginning of the laying period but keep some in the nests (they will attract other hens)

- collect the floor eggs as often as possible every day
- avoid direct sunshine entering the nests
- provide the nests with sufficient and 'pleasant' litter
- place the nests about 50 cm above the floor of the house; if the nests are (much) lower the birds may lay under the nests.

Types of laying nests

a Individual nests

With litter; manual/automatic egg collection.

Without litter; the wire bottom of the nests slopes forward to the egg cradle (so-called roll-away laying nests).

Size of individual nests: width 25-30 cm
 depth 35 cm
 litter retainer about 15 cm

Capacity: 4-5 layers per nest

Perches are necessary for the hens to enter the nest. Removable nest bottoms make the cleaning much easier. With roll-away laying nests the slope in the bottom should be 14%; use wire with a mesh of about 1 cm.

2 Communal laying nests

Sizes e.g. length 2 metres, depth 0.7 metre. Capacity per square metre 50-60 layers.

Use litter with a depth of 15-20 cm so that the eggs can 'sink' into the litter.

Ventilation inside the communal laying nest is very important.

Communal laying nests are not suitable in tropical conditions.

Note:

The following illustrations and other illustrations in this chapter were provided by IPC Livestock Barneveld College, from lecture notes prepared by J.A.Hulzebosch of that College.

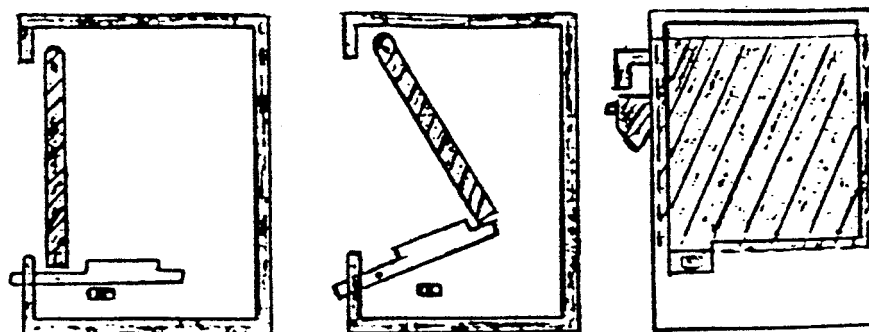

Figure 42: Trap-nest

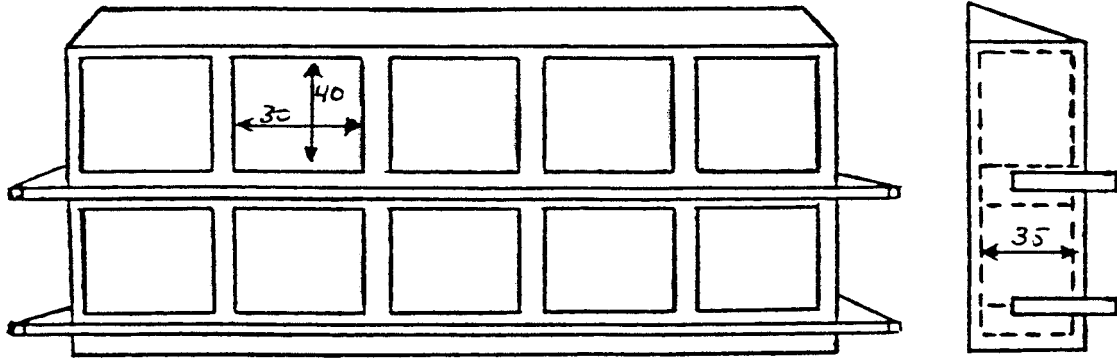

Figure 43: Individual laying nest

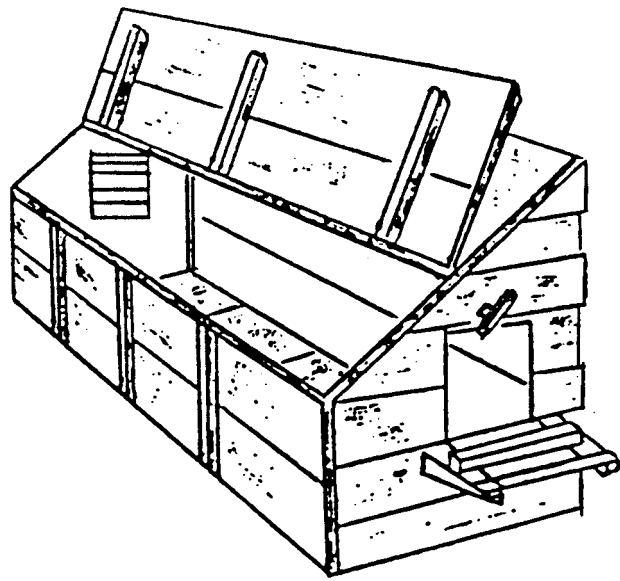

Figure 44: Communal laying nest

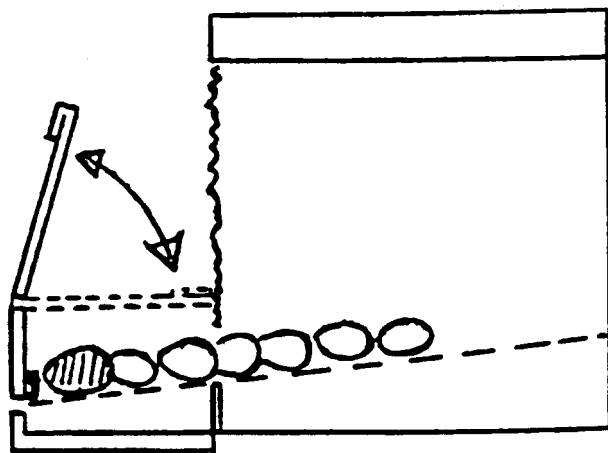

Figure 45: Roll-away nest

3 The feeding of chickens

Chickens need food for:

- the functioning of the body (e.g. movements and feed digestion)
- the making of body substance (for us 'body substance' means the products meat and eggs)

3.1 The composition of chicken feed

Carbohydrates

Carbohydrates (and fats) provide *energy* to the bird.

Especially the *starch of cereals and roots* is important in chicken feeds as supplier of energy. In most countries cereals make up the main feedstuff ingredient for chickens.

In general, grain products are from a practical point of view poor in calcium and rich in phosphorus.

Fats

Fats have a high energy value (fats are 'energy-rich' as we all know). Sometimes extra fats are added to broiler rations, to improve the food conversion rate.

The fat content in cereals is low but maize grain has a relatively high fat content.

Yellow maize turns the skin and fat of chickens yellow and colours the egg yolk.

Crude protein

Unlike ruminant animals, chickens need *high-quality protein* in their ration, because chickens cannot make amino-acids themselves. Protein is made up of about 20 different amino-acids. Of these acids about 10 should always be present in poultry feed, in sufficient quantities and in the right proportions.

Three amino-acids are likely to be lacking in (natural) chicken feed, namely lysine, methionine and cystine. For that reason feed millers make a special effort to guarantee that they are present in their chicken feed formulations.

Lysine is abundantly present in feedstuffs of animal origin and in soybean cake.

Methionine can replace cystine, but not the reverse. Methionine is produced industrially and as such is used in chicken feed formulations.

Crude fibre

Unlike ruminants, chickens can hardly digest crude fibre and it should not be present in excess in chicken feeds.

Chickens only utilize part of the crude fibre in the ration. Only the crude fibre which arrives in the blind guts is digested, with the help of bacteria. This is about 10% of the feed.

Nevertheless, crude fibre in the ration is important because it stimulates the intestinal wall to greater activity.

Inorganic matter (minerals)

Only Ca and P are mentioned here (other elements are also needed). Calcium and phosphorus have the following functions:

- both elements are important for bone formation
- other body tissues of the chicken also need Ca and P and both elements play a role in physiological processes
- egg production requires a large amount of calcium

The egg shell is made up of calcium carbonate for about 90%. Apart from this Ca and P are needed for the formation of egg content.

A laying hen needs about 3.7 g Ca per day. Generally speaking in the tropics, with relatively low feed intakes, to be on the safe side the Ca content of the feed of laying hens should be about 4% (assuming that the feed intake is 100 g).

Other components

The ingredients used for chicken feed normally already contain some *vitamins*. But often the vitamin content is insufficient and extra vitamins are then added by the feed miller. Apart from vitamins other substances may be added; the most important additives are:

- coccidiostats
- antibiotics
- anti-oxidants (to prevent fatty feedstuffs from becoming rancid)

Digestibility and energy content

What the chickens eat is not completely digested; part of the feed can be found in the droppings. The more *digestible* a feed (ingredient) is, the less can be found in the droppings. Hence the term ‘digestibility’ and digestibility coefficient.

Starch and sugars (cereals, roots, tubers, sugar products and fruit) are highly digestible for chickens. But bananas form an exception to this rule.

Fats and oils from lard, coconut and oil palm are less digestible than oils from groundnut, cottonseed, soya and maize grain.

The *protein* of legume seeds and seed cakes quite often needs *heat treatment* to make it digestible and/or suitable for poultry. The heat treatment should be done with precision (neither too little nor too much heat). For instance, soybean seeds and cakes should be heat-treated to make them suitable for poultry feed.

In Europe and the USA soybean cake is by far the most important cake in poultry feeding (about 95%), because of its price, richness in indispensable amino-acids (lysine!) and its relative freedom from toxic substances. The best soybean cake contains about 50% crude protein, 2% fat and 3% crude fibre.

Energy content

In most countries the *metabolizable energy content* of a feedstuff is used to measure the value of a poultry ration as far as energy is concerned.

The unit of ME used to be the kcal; nowadays the unit MJ (Mega Joule) is mostly used; 1 MJ equalizes 240 kcal.

In order to be able to calculate the ME of a feed, one should know the digestibility coefficient (for chickens in our case) and the ME factor of the various components that make up the feed. The ME of a normal chicken feed ranges from 2500-3200 kcal/kg.

Table 5: ME factor of various feed components

		kcal/gram
crude protein		3.8
fats and oils	from animal/fish meal	9.5
	from cereals and seeds	9.3
	from dairy products	9.2
sugars and starches	from cereals	4.2
	from legume seeds	4.0
	from legume leaves/stalks	3.8
	from dairy products	3.7
crude fibre		2.1

Note: the ME factor of fats and oils is relatively high.

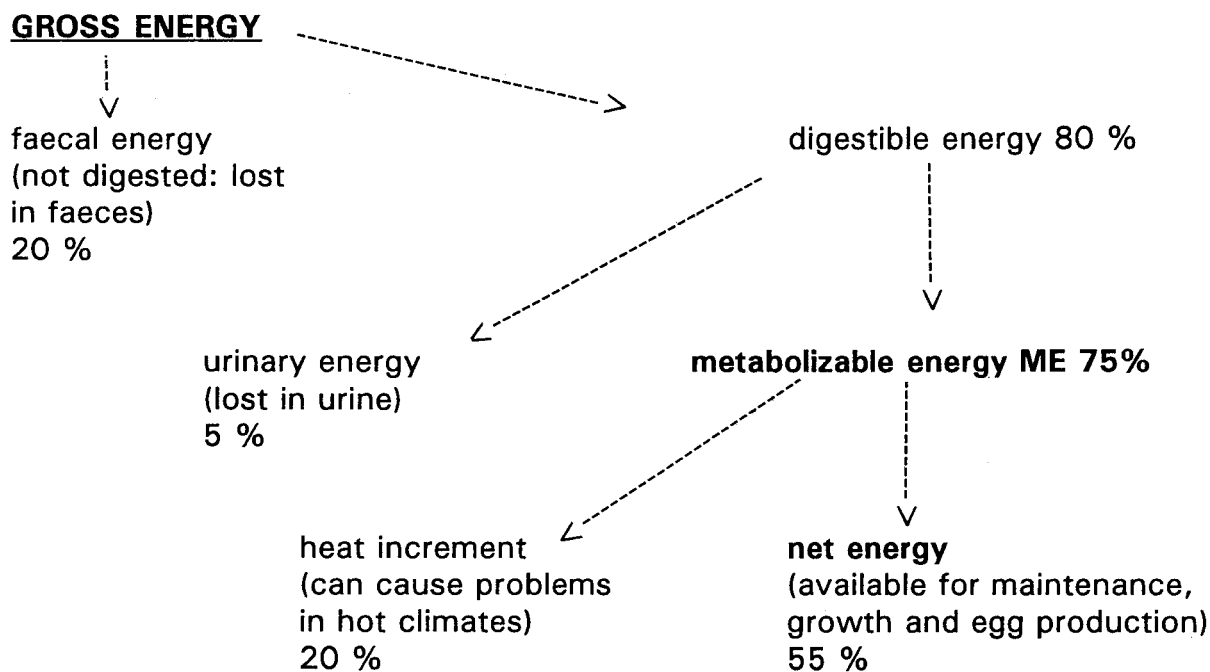

Figure 46: Schematically (indicative)

Table 6: Example: ME calculation for maize meal

	Content g/kg	Digestibility coefficient for chickens	ME factor	ME
crude protein fat crude fibre sugars, starch	9	76	3.8	266*
	1	86	9.3	337
	42	12	2.1	6
	24	90	4.2	2638
	698			
				3247 kcal/kg

* = $91 \times (76 : 100) \times 3.84 = 266$

Energy/protein ratio in feeds

As the chicken grows, relatively less protein is required in the feed; 'starter' feed should contain more protein than the feed for adult birds.

3.2 Mixing feed

Most chicken feed mixtures contain the following ingredients:

- carbohydrates* – mainly grains and grain by-products
- proteins* – oilseed cakes and beans, fish meal, meat meal
- minerals* – sea shell, limestone powder, bone meal sometimes trace elements are included in a premix
- vitamins* – e.g. lucerne meal and premixes; usually in small quantities
- medicines* – sometimes medicines are added to the feed

The mixing of these ingredients should be done *very carefully* because a chicken eats only a small amount of food each day. But this small quantity (only a few tablespoons) should contain *all* the ingredients the chicken needs, *in correct proportion*.

The ingredients used:

- should be fresh; not rancid; free of moulds; not stale

- should not be too fibrous; e.g. hulls are less desirable
- should be free of soil particles and any other foreign material
- especially vitamins and premixes should not be outdated

The most common types of mixtures are:

- baby-chick feed
- young chick feed/rearing number I
- growers I/rearing number II
- growers II/rearing number III
- feed for layers
- feed for breeders

Mixtures are made up according to:

- availability and prices; some ingredients can be replaced by other ingredients, provided that the total amounts of energy, proteins and minerals remain unchanged
- production; chickens in low production, for instance, need less proteins
- the season

Mixing procedures (on the farm):

- Check the total quantity of mixture that is needed (mostly 50, 100 or 1000 kg).
- Weigh off the quantity of each ingredient needed and pour it into the mixing basin or mixing machine.
- The more bulky ingredients and those that are to be used in large quantities first; then the other ingredients are added.
- Ingredients that are to be used in small amounts may be 'premixed' first with one of the other ingredients to be used.
- Start mixing either by rotating the machine or by turning over the ingredients with a shovel; this work is done mechanically when electric equipment is available.
- It is difficult to say when the ingredients will be properly mixed because this depends on: the type of ingredient used, the type of equipment used and on the speed of the mixing.

But a good check is always: a) there should be no colour differences in the mixture and b) it should not be possible to recognize the individual ingredients any more.

Store the mixed feed in containers or clean sacks.

Pre-mixing vitamins and other small amounts

It is advisable to pre-mix small amounts of ingredients such as vitamins, trace elements and medicines, with one of the other ingredients.

Follow this procedure:

- take a quantity of the so-called carrier ingredient that is *twice as big* as the quantity of vitamin, trace element or medicine that is to be mixed
- do the mixing in a bucket or similar utensil
- then double the quantity in the bucket by adding more carrier ingredients and mix again; repeat if necessary
- finally spread the premix evenly over the ingredients that have to be mixed
- avoid the use of any carrier that might have a detrimental effect on the ingredient; for instance, vitamin oils should not be mixed with minerals because the latter tend to accelerate the destruction of fat-soluble vitamins

3.3 Grinding and pelleting

The grinding of certain ingredients on the farm itself may be necessary or attractive for certain reasons (for instance, in the case of farm-produced maize).

In general, grinding gives better digestibility.

It should be done according to the type of feed to be mixed; adult chickens like feed particles of about 6 mm size, young chicks need a smaller-sized particle. Chickens never like dust (material that is too finely ground).

All feed particles should preferably have the same size, otherwise the chickens will select certain sizes, which may lead to an unbalanced ration.

Grinding is usually done by a machine; the 'hammermill' is the most common one. In the hammermill a number of metal parts rotate with considerable speed. They crush the feed particles until they can 'escape' through a number of sieves with a preset gauge.

Operating a hammermill

- Install the sieves as required.
- Fix all screws etc. and tighten them properly because the machine develops considerable speed inside and any loose object may be slung off and cause severe accidents.
- Switch on the (electric) power.
- Pour the material that has to be ground into the funnel of the mill, bucket by bucket in a small machine and sack by sack in a bigger one* Make sure that the mill does not become overloaded; if the mill becomes overloaded, an electric device will cut off the current automatically, but if this device is absent or fails, the mill becomes jammed (switch off the current immediately).
- If the mill becomes excessively hot, switch it off for some time.
- The ground feed should come out of the mill evenly and in a steady flow.
- Any breakdown should be checked by a skilled person (an electrician or another competent person).
- It is most important to avoid metal or other foreign material getting into the mill; such material not only damages the mill, but some foreign materials mixed with the feed may be a danger for the animals that eat them.
- In most machines a kind of magnet is installed that picks up all metals found in the ingredients; clean this magnet regularly.

Pelleting

Sometimes feed is *pelleted* after it has been mixed. Pellets are small cubes varying in size.

The feed is mixed with molasses and/or a chemical (for instance bentonite) for binding purposes and heated with steam. It is then pressed through a number of preset gauges and rapidly cooled down. The steam may also kill bacteria, which is desirable.

Pellets reduce losses due to the blowing away of the finer particles (dust) and losses during storage.

Less feed is wasted during consumption because chickens cannot select between pellets and each pellet is a complete mixture.

3.4 Feed intake and feed conversion rate

Factors affecting feed consumption (in order of importance):

- energy level of the feed
- environmental conditions (especially the temperature)
- type and age of the chickens
- production level
- palatability of the feed
- health of the birds
- activity
- the management system (how much feed is supplied and how)

If there are no feed restrictions the birds will adjust their consumption according to their energy needs, so the higher the energy level the less they eat.

The *temperature* in the house has a particular influence on the chickens:

- the lower the temperature the higher the feed intake
- from 15 to 25 °C feed intake decreases by approx. 1.5% per degree Celsius
- at temperatures between 25 and 30 °C (and higher) the consumption of feed further decreases but the requirements for proteins, vitamins and minerals are still the same; therefore the concentration of these nutrients in the feed should be increased, with obviously a lower energy/protein ration

Thus the nutrient density of the feed should be increased to cope with hot weather. Another effect of hot weather is that egg weight decreases and that the egg shells become thinner.

When birds have free choice of feed, they tend to select the most attractive and tasteful parts (particles) first.

There are several ways to supply feed to chickens: by hand, mechanically, free or restricted, depending on the kind of management that is applied. But *always try to prevent wastage*. Most methods to reduce wastage require extra labour or equipment but are normally well worthwhile.

‘Restricted’ feeding stimulates the chickens to finish the feed so that no old stale feed stays in the feeder that affects the quality of the fresh feed. But ‘unlimited’ feeding (at pleasure, *ad libitum*) is still recommended when maximum growth is sought (day-old chicks and broilers).

Guidelines for layers

Assuming that the layer feed contains 2750 kcal ME/kg:

- for *maintenance*, supply 70 g feed per day, when the bodyweight is 2 kg
- add (or subtract) 1.4 g feed for each 50 g difference in bodyweight
- subtract 3 g feed if the birds are housed in cages
- for production, add 7 g feed for each 10% of egg production
- subtract 1.5 g feed for each degree Celsius ambient temperature higher than 21 °C

If these guidelines are applied to Leghorn-type layers, with a bodyweight of 1900 g, at 70% production and kept in cages at 25 °C, this results in a recommended amount of feed per bird per day of 107 g (approx.).

Although chickens can very well adjust to the amount of feed consumed, the **feed conversion rate (FCR)** will be strongly affected.

In temperate climates it has been demonstrated that the production of layers can be maintained with a variation in energy level between 2300 and 3200 kcal ME/kg. However, the first group eats a great deal more, resulting in a high and unprofitable feed conversion rate.

$$\text{FCR} = \frac{\text{kg of feed consumed}}{\text{kg of chicken product}} \quad (\text{calculated over a certain period})$$

For broilers this FCR may vary from 1.7 (at 5 to 6 weeks of age) to 2.0-2.2 (at about 8 weeks). Early growth is the most efficient (lowest FCR).

Layers (product in kg eggs) normally have a FCR of 2.2 to 2.5

Of course, low-quality feed results in a relatively high feed conversion rate. And feed wastage?

Guidelines for pullets (to replace layers)

During the first weeks the chicks are fed without restrictions (at pleasure) to allow maximum intake of nutrients. Later, the feed may be rationed, to aim for maximum uniformity in bodyweight of the flock. In that case the birds will be hungrier and for that reason there should be enough feeding space and the feed should be distributed quickly, at the same time every day. Nowadays, due to genetic improvement towards smaller (less costly) layers, hardly any restriction need to be applied in the case

of Leghorn-type pullets. Also for medium-heavy pullets restriction has become less important. However, *heavy layers* (broiler parent stock) have to be strongly restricted to avoid a decrease in laying results later on. With unrestricted feeding they would become too fat.

Normally, the chicken breeding companies provide feeding guidelines for their birds. Example:

Table 7:

Weeks age	Light strain Hisex-white Jayar		Medium-heavy ISA-brown layer		Heavy: 1 Hybro Parent stock	
	g.feed/d	body wt.	g.feed/d	body wt.	e.feed/d	body wt.
1	9	260	12	35	15	
2	16		18	100	25	
3	23		23	150	35	
4	30	260	28	200	45	500
5	36	320	33	285	55	650
6	39	400	38	370	65	825
7	42	500	43	460	70*	1000
8	45	590	48	550	70*	1140
9	47	640	52	640	70*	1250
10	49	700	56	725	70*	1350
11	52	770	60	810	70*	1410
12	54	830	64	900	70*	1470
13	57	890	67	990	70*	1530
14	60	950	70	1080	70*	1590
15	64	1010	74	1170	70*	1650
16	68	1060	78	1260	75*	1710
17	70	1110	81	1350	75*	1770
18	72	1160	82	1440	75*	1830
19	76		89	1550	80*	1890
					90*	1950
					150	
					120	

* extra grain or extra crude fibre to supply bulk up to 10 gram/bird/day after 10 weeks

Guidelines for broilers

Broilers should eat at pleasure since extra consumption will result in extra bodyweight and therefore more efficient feed utilization (if no diarrhoea occurs). If broilers are sold earlier (when they are already at proper bodyweight), less feed will be utilized and this results in a low feed conversion rate.

One example of broiler performance:

Table 8:

Age (weeks)	1	2	3	4	5	6	7	8
bodyweight (g)	105	270	510	800	1100	1410	1720	2040
feed cons. g/day	12	38	59	79	90	103	115	125
feed conv. (cum)	0.8	1.3	1.5	1.65	1.77	1.89	2.0	2.1

Feed sources

In animal production the supply of feed is the most determining factor for efficiency and profitability of the enterprise. In intensive chicken farming systems feed costs may be up to 80% of the total costs.

The management should always find a proper balance between the nutritional quality and the cost of the feed.

The recommended concentrations of nutrients in daily rations are well known. However, *the main problem lies in the utilization of cheap, locally available feedstuffs*. In integrated mixed farming these feedstuffs should be utilized as much as possible. But information on the nutritional quality of local feedstuffs is rather scarce and that quality can be highly variable.

For that reason *safety margins* should be applied where required nutrient levels are concerned. Most locally available feedstuffs are of lower quality than imported ones.

Another reason to include a safety margin in the nutrient concentration is that high (tropical) temperatures result in a lower feed intake and therefore a drop in production, if not enough nutrients are consumed.

(adapted from article written by G.W.Bouwman)

3.5 Water supply

For chickens water is a necessity of life of the first order!! Because:

- The body of a chicken consists for 55-75% of water, depending on age.
- An egg has a water content of about 65%.
- The body temperature of a chicken is largely regulated by water (evaporation by panting).
- Water is indispensable for feed digestion and excretion of wastes.
- Water is very often used for administering vaccines and drugs.

Unlike mammals, a **chicken needs water all the time** because it does not have a stomach like mammals have. A chicken cannot retain water and for that reason it has to drink often, but a little a time.

Egg production suffers when there is not enough water.

From approximately 30 °C onwards, the water consumption of chickens increases drastically. One day without water, especially when temperatures are high, can reduce egg production by 30% or more.

Water that is not clean (visibly or not) can undermine the health of a chicken flock and may even cause high mortality. Improper water can make vaccines supplied with the drinking water useless. So, it is of the utmost importance to supply good quality, pure drinking water to the birds.

Water quality

Whether water can or cannot be used as drinking water for chickens can only be determined in a laboratory. Some criteria are:

- it should be clear (limpid), without smell, colour or sediment
- pH between 5 and 8
- hardness: hard water contains various calcium and magnesium salts. In itself hard water is not harmful for chickens but it may influence the functioning of the watering equipment. Hard water in combination with a high sulphate level can cause diarrhoea
- iron: maximum 1 mg/litre. High levels may affect drugs such as tetracycline and sulfa drugs and may affect the functioning of valves and nipple drinkers. The problems with high levels of iron, calcium and magnesium, in particular for vaccinations and drug supply, may be overcome by adding dried skim milk to the water

Water *should not be used* as drinking water for chickens when:

- faecal streptococci or coli-bacteria are present
- gas is formed with the Eykman and McConkey test
- a very high number of bacterial colonies develops on a gelatine or agar plate (100 × dilution)

It is very difficult to judge the water quality by eye.

A too high level of salt NaCl (occurs sometimes in coastal areas) causes diarrhoea, affects the kidneys and may give high mortality. Bacteria and fungi cannot be seen, but can easily upset the intestines of the chickens or cause E-coli outbreak.

Water consumption

Chickens confined to houses entirely depend on human care. They do not have the possibility to find water for themselves!

Consumption per 1000 birds/day, at an environmental temperature of about 30 °C:

- broilers (8 wks) 400 litres; 0.4 litre/bird
- layers 600 litres; 0.6 litre/bird

On average in the tropics an adult chicken needs about ½ litre of water per day, depending on the temperature and the laying intensity.

The *ambient temperature* has an enormous influence on the water consumption of chickens. A layer kept at 45 °C needs in principle about 3x the amount of water consumed by a layer kept at 15 °C.

However, water consumption not only depends on the ambient temperature; also water temperature and NaCl content are important factors.

Chicks, growers and layers prefer water with a temperature of around 15 °C. If the water temperature drops below 5 °C or exceeds 35 °C, the water consumption falls, resulting in lower production (broilers and layers). In hot conditions, try to provide relatively cool drinking water.

4 Management of pullets

4.1 The management of chicks from 1 day to 8 weeks old

During the period from 1 day to 8 weeks (brooder period) young chickens need special care.

Temperature

Young chicks cannot yet regulate their body temperature themselves. So, normally *artificial heating* is provided during the brooding period.

Brooder operations in temperate climates require heating of a whole house. In the (sub)tropics heat may be provided to a particular area in the house, a corner or one room only, at least during the night.

Artificial heat sources are:

- electric brooder (infra red heat bulbs)
- gas broode (gas heaters)
- kerosene brooders (kerosene lamp/kerosene heater)
- other fuel sources (e.g. charcoal)

Recommended temperatures at chick level depend on breeds (e.g. whether feathering is rapid or slow) and the type of chicken. By way of example the recommended temperatures for broiler chicks:

- 1st day 33-34 °C
- 2nd day 32
- 1st week 30
- 2nd week 30-25
- 3rd week 28-25
- 4th week 25-20

When the temperature is *too high* we see that:

- the chicks sit with spread-out wings and open beaks (rapid breathing).
- the chicks sit as far as possible away from the heat source.
- there is less feed intake: the chicks drink more and this often causes wet litter.
- there is more (risk of) feather pecking.

When the temperature is *too low* we see that the chicks:

- come close together
- are less active
- will raise their feather cover
- will stay close to the heat source

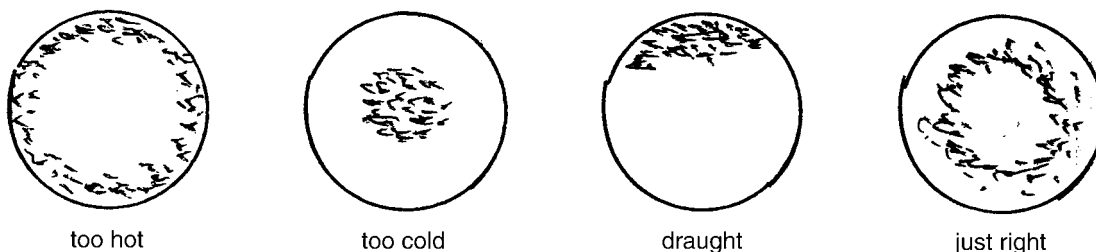

Figure 47:

Light

The chicks will eat when there is light. As eating must be stimulated especially early in the brooder period, artificial lighting is a must. However, gradual reduction of the light is recommended:

- 0-1 week: 23 hours light (including daylight)
- 1-2 weeks: 20 hours light (ditto)

- 2-4 weeks: 16 hours light (ditto)
- From 4 weeks onward a constant daylength of 14 hours seems advisable.

If light bulbs or lamps are used as a source of heating, this may upset the above lighting schedule, because they provide light as well as heat. This can be overcome by having two sets of bulbs or lamps, one of which is painted blue (heat but no light) as chickens cannot see in blue light.

Confinement

To confine the chicks around the source of heat and to prevent draughts it is necessary to erect a so-called *brooder guard* around them; for instance made from 2 pieces of plywood joined to make a circle; about 50 cm high. There should be no cracks in this guard as they will cause draughts.

Provide a cover over the guard in order to keep the heat inside, *but prevent fire (!) and allow for ventilation.*

Note: one piece of plywood is 120 × 180 cm.

If cut into two pieces of 60 × 180 cm, and joined together, the size of the brooder guard will be 60 × 360 cm. A circle with a circumference of 360 cm covers an area of approximately 1 m². This is enough for 100 chickens.

Litter

Litter absorbs moisture (from droppings) and provides scraping material for the chicks.

The best material for litter is *short* wood shavings. Other suitable materials are sharp sand or ground-nut hulls or rice husks.

At all times prevent litter from getting *wet or dusty.*

Equipment

During the first few days, it is enough to spread the feed on paper or cardboard. After three days small *feeders* should be used.

The feeding space per bird should ‘grow’ from about 3 cm at day-old to 6 cm at 10 weeks. Check: all chicks should be able to feed at the same time.

During the first weeks normal *drinkers* (founts) are used but with a low brim. If not available, empty bottles can be used for the first four weeks; they must be put upside-down on a plate or shallow tin can. The bottles must be prevented from tipping over. Check the water consumption regularly.

Table 9:

Number of chicks	Brooder space	Lamps 60 W	Drinkers	Feeders
up to 50	½ m ²	2	2-3	2-3
50 to 100	1 m ²	3	3-4	3-4
100 to 200	2 m ²	3	4-5	4-5

Feed

Special baby-chick feed is required, to which a Salmonella-controlling medicine is added. If necessary the feed should also contain a coccidiostat.

Normal feed consumption per bird/week:

Table 10:

Week	Meat-type	Medium size	Leghorn type
1	70 g	70 g	45 g
2	240	120	90
3	260	175	135
4	280	230	180
5	350	280	225
6	420	330	270
7	470	380	315
8	470	420	360
	2560 g	2005 g	1620 g

But: actual feed consumption may differ considerably from the above figures, due to climate or to spoilage.

A (small) excess quantity of baby-chick feed should always be in stock on the site (just in case) even under the most favourable conditions of feed supply.

Health and condition at arrival

Day-old chicks should preferably be delivered in the morning when it is still cool; this also makes it possible to observe them for a full day.

Do not allow the personnel delivering the chicks to enter the chicken house.

Further:

- check mortality, quality and thriftiness of the chicks
- place the chicks in the brooder heat
- small numbers can be counted, larger numbers have to be estimated
- if the chicks have to be vaccinated (preferably by the spray method) - do this quickly and efficiently
- provide the chicks with quietness

Some standards for chick quality at arrival are:

- no deformities
- no unhealed navels
- above a minimum weight
- not dehydrated
- down colour representative of the breed
- chicks standing up well and being lively

Males can be recognized at 6-8 weeks in unsexed flocks by the following characteristics:

- in cocks the feathers are more pointed than in hens, whose feathers are smaller and rounded
- cocks usually have a bigger comb
- cocks stand in a more upright position than hens

Record keeping

House list:

- house number, batch number, period concerned
- feed consumption per feeding time/per day/per week
- number of birds found dead, number of birds culled
- number of hours that electricity was on (or other heat source)

Summary:

- batch number, house number, breed and source, period concerned
- feed consumption, cumulative and average feed consumption per week/8 weeks
- number dead/week/8 weeks + % mortality + cumulative %

- number culled/week/8 weeks + % culling + cumulative % . energy consumption: total number of hours ×
- type of feeds (+ period feed)
- vaccination date, against what, serial number, vaccinated by whom
- medication date, against what, name and dosage (concentration) of the medicine, reason for medication

Records for the house list should be kept daily. The summary is drawn up weekly and completed at 8 weeks.

The summary gives an overall idea and helps to improve (future) management.

4.2 Management of growers

The period concerned is between 8 and 22 weeks of age. Growers are the future laying birds and the way they grow up will largely determine how well they do in the laying house. Therefore management during the growing period is very important.

Follow a programme that has been carefully prepared in advance.

Housing

Roughly speaking, three housing systems can be distinguished:

- 1 Brooding-growing-laying house in one.
- 2 After the brooding house the birds are transferred to a growing/laying house.
- 3 After the brooding period, the birds are transferred to a growing house and from there (at 18 weeks of age) to a laying house.

In system c) chickens are sometimes reared outdoors on pasture during the growing period:

- chickens grow well in sunshine and with fresh grass and the costs are low
- but they should not be kept on bare ground especially when there are (dirty) water puddles
- there should be ample shade and plenty of grass
- the risk of diseases is high as there is contact with wild birds

Floor space requirements for growing birds are higher under tropical conditions (indicative only):

Table 11:

Type of chicken	Litter floor	Half wire/slats half litter	Wire/slats
	birds/m ²	birds/m ²	birds/m ²
Leghorn egg type pullet			
to 18 weeks	8	10	15
to 22 weeks	6	8	10
Medium size egg type pullet			
to 18 weeks	6	8	10
to 22 weeks	5.5	7	9
Meat-type breeder pullet	4	5	-
Meat-type breeder cockerel	3	3.5	-

Fill the house (with birds of 8 weeks old) according to the stocking rates in the above table, but increase the numbers with the expected losses.

Water requirements for growing birds (indicative only):

Table 12:

Type of chicken	Watering space		Water consumption/bird/day		
	straight drinkers	round drinkers	16 °C	27 °C	38 °C
Leghorn-type pullet and cockerel	2 cm	1.3 cm	250 cm ³	300 cm ³	600 cm ³
Meat-type pullet	2.5	1.7	270	330	660
Meat-type cockerel	3	2	300	400	750

From the table it follows that the water consumption per bird ranges from 1/4 to 3/4 litre, at the given temperatures. Note that the water consumption increases considerably with a rising temperature! Always provide enough water ('at pleasure').

Feeder space requirements for growing pullets and cockerels (indicative only):

Table 13:

Type of chicken	Straight feeders cm/bird	Round feeders cm/bird
Leghorn egg type pullet	6.5	3.8
Medium size egg type pullet	7.5	5.1
Meat-type breeder pullet	10	6.4
Meat-type breeder cockerel	13	7.6

Notes:

- feeders and drinkers should never be more than 3 metres apart
- the height of the feeders (and drinkers) should be regularly adjusted so that the bottom of the feeders remains roughly at the same height as the back of the chickens. This will reduce feed waste
- fill the feeders to one-third only; more than this leads to waste

Restricted feeding means that a certain (calculated) amount of feed is given daily that results in a weight increase programmed in advance.

In this system all birds should be able to feed at the same time. Feeders must be filled quickly and evenly.

With *full feeding* (feeding to appetite) feed is available all the time, but there is not much feed in the feeders so that waste and feed selection (by the chickens) is avoided. Feed that is not consumed should be pushed aside before the feeder is refilled.

Growing house arrangements

1 Litter floor:

The feeders and drinkers should be evenly spread throughout the house:

- crosswise in a wide house
- lengthwise in a narrow house

Feeders and drinkers should not be more than 3 metres apart.

The birds should be trained to use the *perches*. It may be necessary to place them on the perches for several successive nights.

2 Partly wire/slatted floor:

Young birds should be trained to use the wire/slatted area; for that reason feeders and drinkers should gradually be placed on the wire/slats.

At first the chickens will bed down on the litter at night, but as they become older they should all roost on the perches.

3 Wire/slatted floor:

As wire/slatted floors are colder than litter floors, chickens kept on wire/slatted floors may huddle together during the night in order to keep warm. But this 'crowding' should be avoided: try to spread the birds evenly throughout the house and make partitions in big houses.

Special management procedures

The *litter* should contain 20-30% moisture.

How to check the litter condition:

- pick up a handful of litter and squeeze it tightly; then open the hand;
- if the condition of the litter is correct, 'cracks' should develop in the compressed material; it should neither fall apart nor form a cohesive ball (something in between is required).

The litter will contain billions of *unsporulated coccidia*; whenever litter becomes wet, the coccidia will sporulate. Gradual withdrawal of the coccidiostat in the feed together with a mild coccidiosis infection will give the chickens immunity. But it requires a lot of experience to expose the birds to coccidia just enough to obtain reasonable immunity (not enough = no immunity; too much = severe losses).

Also see Chapter 9.1 on this subject.

Sanitation is very important during the growing period: - keep everything clean - refresh disinfectants regularly - keep visitors out

If *worms* become a problem, start a worm control programme. But first of all try to find out which type of worm is involved.

Rats and mice can consume a lot of feed and spread diseases. Start an elimination programme if they are present.

Breeder birds should be tested to be sure that they are free of:

- Pullorum (Bacillary White Diarrhoea, BWD)
- Mycoplasma gallisepticum (Mg)
- Mycoplasma synoviae (Ms)

This is usually done by means of blood testing just before the laying period.

Growing houses should be *separated* from houses containing birds of other age groups.

A *strict vaccination programme* should be carried out and the chickens should be tested to see whether they have developed immunity.

If a *disease* breaks out, some birds which show typical symptoms should be sent to a disease diagnosis laboratory (if possible). Nevertheless, try to control the outbreak promptly, if necessary even before the laboratory results are known, because the longer one waits the more difficult it becomes to cope with a chicken disease.

Watch the medicine *dosage* very carefully. Do not *overtreat or undertreat* birds.

Cockerels should be separated from the flock as soon as possible and reared separately.

Reduction of light (daylight or artificial light) during the growing period will delay the beginning of egg laying, which is an advantage in the case of breeder birds.

Reduction of daylight is only possible in windowless houses. In open-front houses the daylight cannot be restricted.

Inferior, crippled, injured and deformed birds should be removed from the flock **daily** (culling).

Use a catching hook and remove such birds quietly, without disturbance.

Relevant information should be *recorded* (record keeping).

Carefully kept records inform the poultry keeper about the past and are helpful in planning future operations.

Weighing of chickens

The bodyweight of hens (or cocks) plays an important role in various management decisions which have to be taken during the rearing and laying periods.

In order to be able to base management decisions, especially feed supply, on the bodyweight of the birds, it is necessary to determine the *average bodyweight of a flock* as accurately as possible.

Chickens kept for laying must be *weighed* during their growing and laying periods. Their weight should then be compared with set standard weights.

A correct body weight at a given age is of utmost importance for good laying. In particular, *meat-type and medium-size breeds tend to become too heavy* during their growing and laying periods. Therefore breeder birds should be weighed *weekly* during the growing period (starting at about 4 weeks of age) and then every four weeks during the laying period.

Leghorn-type birds have less chance that they will over-eat themselves.

Commercial egg-laying birds should be weighed every four weeks during the growing period (starting at about 7 weeks of age) and then every ten weeks during the laying period.

Daily feed allocations are based on farm experience and research.

For each body weight at a certain age, a certain amount of feed is allocated according to the type of bird and the stage of production.

Differences in weight may exist between different strains of birds. The environment, type of feed supplied and its quality may also influence the weight.

Weekly feed allocations must be adjusted according to the actual weight of the birds.

Procedure

- The tools which are needed are a catching screen with 6-8 'compartments' each about 60 × 100 cm and a weighing scale accurate to 20 grams.
- Start weighing of broiler parent stock when the hens are 4 weeks old.
Weigh *every week*, on the *same day*, the *same time*, preferably in the morning before feeding. If a skip-a-day feeding programme is in force, weigh on the 'no feed' days, also at the same time.
- Take the sample in the middle of the house. If the house is more than 15 m long, take two samples, at the front and at the rear side of the house.
- Take a minimum of 50 hens in each house (pen).
- Weigh the hens individually and register the bodyweights individually.
- Males are not weighed in the rearing period. It is expected that they take care of themselves, at least in mixed rearing.

If the rearing is done separately, it is advisable to weigh the males in the same way as the females.

The actual weighing

Suspend or place the scale, close to the spot where the birds will be collected.

Collect the required number of birds inside the catching screen; remove the males from the screen as this will make the hens more quiet.

Take one hen out at a time and weigh her. This can be done in two ways:

- with a rope (string) around one leg
- with a cone (head downwards)

In both cases it is absolutely necessary that the bird hangs as quietly as possible. Therefore hold the bird at the thighs and not at the shanks.

After weighing, release the hen quietly and place her on the floor again. Do not drop the bird on the floor because this could cause foot and/or hock joint injuries.

All the hens inside the screen should be weighed!!

Read the bodyweights as accurately as possible, up to 10-20 g; think of the weight of the rope or the cone.

Recording

The bodyweights are recorded individually, on a special card. Also note the maximum and minimum bodyweights on this card.

The average bodyweight is:

$$\frac{\text{total weight, in grams}}{\text{number of birds weighed}} = \dots\dots\dots \text{ grams}$$

Uniformity

Now we know the *average* bodyweight. But this does not say anything about the differences in individual bodyweight in the flock.

The start of laying is partly determined by bodyweight. We want the hens to start laying all at the same time; hence, it is clear that the differences in bodyweight should be as small as possible. We want our flock to be *uniform*: a uniform flock is a flock in which individual bodyweights are grouped closely around the average bodyweight; this can be expressed with a graph.

Every breeding firm provides data showing the required average bodyweight and the desired % of uniformity during the rearing period.

These are different for each breed.

How to determine the ‘uniformity’ in a flock:

- plot the individual bodyweights, with intervals of 25 grams, on the bodyweight uniformity card
- plot the allowable variation in bodyweight
- count the number of birds falling within the limits
- calculate the uniformity % :

$$\frac{\text{number of birds within limits}}{\text{total number of birds weighed}} \times 100$$

Conclusion

It is very important to control the bodyweight of a flock, if one wants to have good performance. This is especially necessary in the rearing period. Some important points are:

- use the correct weighing method
- take the right sample
- weigh the birds on a regular basis
- if bodyweight is not on target, *do something about it*.

4.3 Cannibalism

‘Cannibalism’ is a well-known problem in chicken farming; particularly in ‘biological’ chicken farming in which debeaking is out of the question. Hens will peck and fight each other in order to establish the ‘pecking order’ in the flock. Some hens may continue this habit of pecking and start feather pecking. This easily leads to inflicting wounds to other hens. At this stage the pecking is called *cannibalism*. Once hens have tasted blood, they are able to kill other hens by pulling out their intestines after having injured their cloaca. Remove the affected birds immediately.

Just before an egg is laid the cloaca is partly sticking out. The reddish colour seems to stimulate other hens to start pecking at it. Sometimes eye- and combpecking can be seen, but this must not be confused with fowl pox.

Flock mortality due to cannibalism can be as high as 70%.

It is not known what exactly causes cannibalism. The only thing a farmer can do is to work on the factors possibly influencing cannibalism. Providing suspended green feed may help.

Debeaking the hens is commonly done in order to prevent cannibalism.

Cannibalism occurs in all types of chickens: pullets, layers, broilers and breeding flocks.

In *broilers* it can cause high mortality and it can reduce the slaughter quality. Broilers can be debeaked as day-old chicks.

Breeding flocks can produce many infertile eggs because some cocks may be afraid to walk around in the house and fertilize the hens.

Possible causes of cannibalisms followed by prevention/treatment:

Table 14:

	Causes of cannibalism	Prevention/treatment
The hens	heredity; one flock shows more cannibalism than another	selection in the breeder flocks
	much 'prolapsus' because laying starts too early or because pullets are too fat	proper feeding programme
	debeaking is done too late, the pullets are already used to feather pecking	debeaking at early age
	the flock feels 'bored', the birds are not kept busy enough	supply cereals in the litter, or green feeds or sods with grass
	the smell of blood on pecked and wounded birds	put something on the wounds that is unpleasant for the pecking birds; a useful mixture is oil + sulphur powder + tar
	moulting	remove early and late moulting hens
The feed	low % of crude fibre (CF) in the ration, e.g. in ration with high % of maize	use 2% CF for broilers and 4% CF for older hens, as a minimum
	pelleted feed; hens need little time for eating	<ul style="list-style-type: none"> ➤ change over to mash feed ➤ supply green feeds (grass or legumes) ➤ supply extra cereals
	unknown; may be lack of minerals	add 2% salt to the ration
	may be lack of the amino-acids arginine and methionine	<ul style="list-style-type: none"> ➤ add some rice products to the ration ➤ add animal products if available ➤ add maizegluten meal ➤ add sesame cake
Housing	bright light in the house stimulates pecking	in open houses it is difficult to reduce lighting; but <ul style="list-style-type: none"> ➤ make roof-overhang longer ➤ hang empty bags near windows ➤ prevent direct sunshine in the house
	laying nests are too light and the cloaca colour is clearly visible to other hens	make nests darker by hanging some empty bags in front of them
	temperature and humidity are too high	<ul style="list-style-type: none"> ➤ use thermometer ➤ increase ventilation
	not enough laying nests	add more nests
	many floor eggs	place some nests on the 'problem' places
	insufficient eating and drinking space	add drinkers and feeders
	the house is overstocked	reduce the number of birds in the house
	irritation of the skin through direct sunlight	make the roof-overhang longer
Health	lice infection	treat birds with insecticide
	Gumboro disease or IBD cause cloaca pecking	preventive vaccination

4.4 Debeaking

Debeaking (also named beak trimming) is the cutting of the points of the beaks.

It is a *precision operation and hence must be carried out very carefully*. The wound must be *cauterized*, especially when there is bleeding.

The debeaking operation causes an enormous stress to the birds and for that reason everything must be done to reduce stress before, during and after debeaking.

There are **two** debeaking methods, namely 'hot' and 'cold'; with the 'hot' method cutting and cauterizing are done at the same time. With 'cold' debeaking the beaks often regrow.

Various debeaking instruments are available on the market.

Age at debeaking

Opinions differ as to the best time for debeaking. In general, the younger the bird, the less stress the debeaking causes.

Debeaking is done from one-day old to 18 weeks.

Advantages of debeaking **at one-day old:**

- it prevents cannibalism at early age
- the beaks are soft
- chicks are easy to catch and to handle
- it can be done in the hatchery
- high working speed

but:

- chicks have a painful beak just when they have to learn eating and drinking
- chicks inhale hot air
- the beaks can easily be damaged
- often re-debeaking is necessary, just before the start of laying

Advantages of debeaking **at 6-10 days:**

- the beaks are still soft and there is less stress than in debeaking at a later age
- the birds are still relatively easy to handle and a high working speed is possible
- there is less feed wastage during the rearing period

but:

- up to 20% of the birds need re-debeaking before the start of laying
- poor debeaking can damage the birds and even lead to high mortality
- sexual maturity (start of laying) can be delayed

Debeaking **from 8 weeks to 18 weeks** concerns future laying birds.

The beaks must be cut separately in this case and the corners of the beaks should be rounded off by applying heat.

Problems:

- the debeaking is more difficult and gives more work
- risk of cannibalism before the debeaking
- there is more stress for the birds
- there may be a serious loss of bodyweight; it can take 2-3 weeks before the pullets regain the bodyweight they had just before debeaking
- more bleeding and more problems with feed and water intake may be expected
- poor debeaking may lead to increased feed consumption during the laying period

Debeaking procedure; recommendations

Cut the beaks of older birds separately; always cut the upper beak first.

Cut 1/3 to 1/2 of the upper beak; cut the lower beak to the same length or make it (slightly) longer.

Prevent stress as much as possible.

before debeaking:

- be sure that the flock is in good health
- let the birds fast for some hours; an empty crop gives less stress
- do not vaccinate just before debeaking
- arrange for proper separation between debeaked and not yet debeaked pullets
- do the debeaking in or near the house, because this will cause less stress
- sharpen knife or blade
- supply the birds with vitamin K for some days; this is likely to reduce bleeding

During debeaking:

- enough light to see what is done
- use sharp knife or cauterizing blade
- be seated during the work and take a rest now and then
- do not burn the tongue of the bird
- cut the beaks of older birds separately
- when using plier or knife, have a hot iron at hand to cauterize the wound
- when using an electric debeaker, be sure of the right voltage; the blade must be bright red (heat)
- make sure that no beak is bleeding after debeaking
- handle the birds with care
- regularly clean knife, plier or blade during the work
- work as swiftly as possible, but maintain quality!

After debeaking:

- do not restrict feeding just after debeaking but increase the feed and water level somewhat - the beaks are painful for some days
- control water intake when using a nipple system
- if the birds refuse to eat and drink, then dress the feed with some water
- add some vitamins and antibiotics to the feed for one week (A, B complex, D3 and K)
- dip bleeding beaks in some feed or sand
- give extra hours of light for some days, to enable the birds to eat longer - this will help the healing process
- check the flock regularly for lice, because the birds cannot clean themselves properly after debeaking

Debeaking errors

Table 15:

a split lower beak	<ul style="list-style-type: none"> ➤ cauterizing blade too cold ➤ blunt knife or blade ➤ too high a pressure on beak
lower beak with knotted excrescence (abnormal outgrowth)	cauterizing blade too hot
beaks regrow completely	not enough has been cut off
debeaking too short	<ul style="list-style-type: none"> ➤ reduce working speed ➤ do not debeak very young birds
lower beak shorter than upper beak	treat the beaks separately; always cut the upper beak first
burned tongue	cut beaks separately and push back the tongue
upper beak too short	cauterizing takes too long and horn of beak is damaged
beak regrowth on the sides	beaks are not cut in 90° angle; more problems with light breeds than with medium breeds

Debeaking is a *precision operation* and requires skill and experience (routine).

Careless work or work that is done too rapidly results in losses - the flock will not reach a proper bodyweight, the feed consumption will be too high and the flock's top production will be missed.

But debeaking carried out properly, with the right equipment and by skilful persons, is likely to raise the profitability of a flock.

4.5 Checklist for the growing period

1 One week before the chicks arrive:

- The house should have been cleaned and disinfected thoroughly; all equipment should have been installed after proper disinfection
- The disinfection room (with bath!) at the entrance to the house should have been prepared. Use this *disinfection room (bath)* once the disinfection of the house and its equipment has been completed.

Any and all things that are brought into the house after its disinfection, should be disinfected before being allowed to enter.

- The house should be wild-bird proof.
- Keep rats, mice and other pests out.
- Stop draughts. Use mats to reduce air flow, if necessary.
- Lock the house.

2 24 hours before the chicks arrive:

Temperature

- 1 temperature near the heat source should be about 35 °C; room temperature not lower than about 28 °C
- 2 set up brooder guard around the heat source
- 3 hang a thermometer in each brooder guard and one in each pen, at about 1 metre height.

Lighting

- check whether all bulbs are in order; light intensity should be about 4 watt/m² of floor area and the bulbs should be at 2m height

Litter

- 1 put down dust-and mouldfree litter to a minimum depth of 5 cm
- 2 if litter is 'bite-sized', cover it with paper for a few days
- 3 when using a wire/slatted floor, spread paper or plastic sheeting over the wire/slats and put litter on it

Feeders and drinkers

- 1 put clean feeders around the brooder guard like the spokes of a wheel
- 2 provide 2-3 founts (depending on type) for every 100 chicks and place them on tiles or bricks between the feeders

Bird density

- brooder batches should not exceed 200 chicks per brooder; make sure that a sufficient number of brooders is available

Pre-arranged programmes and record keeping

Hang in distinct place in front of each pen:

- 1 the lighting schedule

- 2 the feeding programme
- 3 the vaccination programme

Keep accurate daily records of mortality, feed intake, house temperatures and other data.

3 Arrival of the chicks:

- Put filled drinkers in position several hours before the chicks arrive
- Make sure of strict sanitation during the unloading job
- Remove chicks from the boxes as promptly as possible and put the chicks into the brooder guards

Should immediate unboxing be impossible, prevent boxed chicks from remaining too long in hot surroundings; place the boxed chicks in a room, e.g. the service room located in front of the brooder house.

- Provide the right light intensity = 4 watt/m² of floor area and allow 23 hours of light daily
- Start the chicks on a good quality all-mash starter ration

4 1st day:

- The best check on the brooding temperature is the behaviour of the chicks. If the temperature is correct, the chicks will be evenly distributed immediately around and under the outer edge of the heat source. If the temperature is too low and the chicks are cold, they will huddle together under the centre of the heat source. If the temperature is too high, the chicks will move away from the heat source. Crowding against the brooder guard is an indication of floor draughts.
- Check frequently whether there is clean drinking water in all drinkers
- Prevent the chicks from tumbling into cavities below feeder plates or holes in the litter

5 2nd to 7th day:

- Provide chick-size, insoluble grit starting the third day
- Gradually reduce room temperature and brooder temperature
- The relative humidity may range from 60-80%
- Gradually expand the brooder area (if possible)
- Check chick vitality. If there are chicks soiled with faeces on the vent area, remove this to prevent constipation
- Promptly remove dead chicks from the house
- Remove the paper sheets covering the litter

6 Second week:

- Gradually reduce room temperature
- Remove brooder guard (completely)
- Start ventilation at very low rate when atmospheric conditions are favourable; remove mats gradually. Beware of cold, strong winds and dust storms
- Put in additional feeders and locate them further away from the heat source
- Turn off heating if need be
- If culling and mortality is higher than normal, call in a specialist

7 3rd week:

- Gradually lower brooder temperature even more, if possible and necessary. Keep humidity at an acceptable level by ventilation
- When changing to automatic feeders and drinkers, make the change gradually. Let the chicks get acquainted with the automatic feeders and drinkers and their location by placing the troughs and founts the birds have become familiar with nearer and nearer to the automatic equipment. Then gradually remove the 'old' troughs and founts.

- Reduce light intensity to 2.8 watt/m² of floor area. Adjust day lengths on the basis of the lighting schedule
- Provide plenty of clean, fresh drinking water for the birds at all times
- There should not be any leftovers of feed in the troughs
- Check the condition of the litter and add new, dry material
- With wire/slatted floor raised chickens, start removing the sheeting at the end of the third week
- Eliminate all obvious culls and chicks with deformities

8 4th week:

- Reduce light intensity to 2.0 watt/m² of floor area. Maintain this rate as strictly as possible. Prevent any unnecessary deviation from this lighting standard (clean bulbs and reflectors regularly)
- Check lighting schedule
- From this week onwards it is essential to check the weight of the birds. Keep accurate daily records of average feed consumption on a per bird basis
- Should cannibalism occur, try to stop it e.g. by debeaking the birds

9 5th to 10th week:

- - 1 stocking rate: 9-12 birds/m² depending on housing system
 - 2 feeding space: about 10 cm per bird
 - 3 drinker space: about 2 cm per bird
- Switch over from chick-size to grower-size insoluble grit
- Adopt an established feeding programme and stick to it. Avoid indiscriminate changes from brand to brand as well as sudden changes from kind to kind. Make the change from starter to grower mash gradually. Feed a mixture of the old and the new feed for at least a week.
- Select breeder birds for meat production at 6-8 weeks according weight

10 10th to 18th week:

- Birds which will be kept in cages or in open-front houses should be debeaked. If debeaking has been done at an early age, check whether it has been done properly and re-debeak, if necessary
- Do not allow stresses to accumulate, such as debeaking, vaccination and feed change-over all at the same time
- Compare the birds' weight records with the standard body weight for the same age

5 Management of laying stock

Introduction

The *laying period* is taken to have started when the birds reach 5% egg production on a hen/day basis. The laying period continues until the birds are sold at the end of a laying period of normal length, or are force-moulted. Housing time starts with the beginning of the laying period. The number of birds housed is the number of pullets in the laying house when egg production starts.

Because of variations in rearing management procedures pullets may be transferred to permanent laying houses (in the multi-stage system) at ages between 8 and 21 weeks. Laying houses are thus used for 'growing' for different periods of time before the birds reach 5% egg production on a hen/day basis.

The following *types of birds* are used for commercial egg production:

- 1 white Leghorn type
 - 2 medium size type
 - 3 any cross between these two
- (2 and 3 are used because they produce a brown or tinted egg.)

In commercial egg production cocks are not allowed in the laying house because they consume feed and fertilized eggs spoil more rapidly than unfertilized eggs.

5.1 Preparing the house for layers

At the time when chickens are moved from growing quarters to laying quarters, the following jobs should have been done already:

- cleaning of the house (thoroughly!)
- provision of fresh litter (dry, clean, free of mould), with a depth of about 10 cm, at acceptable cost
- putting in place of all necessary equipment, in working condition

If the chickens are grown in the laying house, the above points need not be observed, but:

(a) nests should be brought in about a week before the first eggs are laid and proper nesting material should be provided and (b) a selection should be carried out; all birds considered to be unfit for laying should be removed.

If pullets have to be *moved* (transferred from one house to another), then apply the following rules:

- handle the birds carefully; catch them by both feet and do not pick them up by the wing
- do not move birds during the hot part of the day; shift them in the early morning or better still, during the night
- use a tranquillizer in the feed or water, to keep the birds calm

5.2 Feeding the layers

At 21 weeks (or 30% egg production on a hen/day basis, whichever comes first) make a gradual change from the grower mixture to the layer mixture.

Use a mix of both feeds for at least one week.

An increase in lighting time should coincide with the change of feed.

Grower feed only contains enough calcium to support growth and bone development. It does not contain enough calcium for maximum egg production.

Start feeding calcium carbonate (oyster shell) near the end of the growing stage, at about 16-18 weeks of age.

Give feed according to the weight of the birds and the schedule that has been laid down in advance.

Watch out for a drop in feed consumption; this is the first sign of trouble to come. About 70% of the costs in poultry keeping are *feedstuff costs*, so waste cannot be tolerated; check regularly whether feeders function properly and eliminate rodents!

5.3 Managing the flock

In hot climates artificial lighting permits the birds to eat when the temperature is relatively comfortable (high temperatures diminish the appetite of the birds!).

Do not deviate from the lighting programme that has been decided upon in advance.

Collect the eggs several times a day, e.g. at the following hours (natural daylight):

3 hours after sunrise (say 09.00 hr), 5 hours (11.00 hr), 7 hours (13.00 hr) and 11 hours (17.00 hr).

With an artificial lighting programme the hours of egg collection should be adjusted to the time that the light is on.

During hot periods it may be necessary to collect the eggs more frequently.

Gather the eggs on flats (key-trays), not in baskets or buckets (extra breakage!).

Pack the eggs with the narrow end down and cool them to 15-18 °C as soon as possible.

Dirty eggs may be cleaned by rubbing with a very fine cloth while dry. They should **never be washed**, because this would favour the entrance of bacteria through the shell of the egg.

Broodiness can be treated by placing the broody hen in a small cage with a wire floor. Suspend the cage in the air (rope); the swinging of the cage will make the hen lose her broodiness.

Prevent the laying of so-called *floor eggs*:

- place nests in the darkest spot in the house
- provide suitable and ample nesting material
- make sure that the number of nests is adequate
- close the nests at nightfall
- darken the nests with a kind of curtain

Daily culling of inferior and unproductive birds is necessary. Do this quietly, without disturbance.

Maintain strict *sanitation* and medicate when necessary.

Keep *records* of important data. Fill in the forms daily and compute weekly. Compare the results with the standard figures (the norms).

Table 16: Floor space requirements (for over 100 birds per pen; when there are fewer birds they will need more space per bird)

	Leghorn type		Medium size	
type of floor		birds/m ²		birds/m ²
litter		6		5
wire/slats and litter		7		6
wire/slats		10		9

The above figures are for maximum bird density.

A lower density normally gives higher egg production per bird but increases the housing costs per bird. It is important to strike the happy medium.

Table 17: Feeder/drinker space requirements (indicative only)

	Leghorn type	Medium size
straight feeders	10 cm/bird	12 cm/bird
round feeders	5	6
straight drinkers	2.5	3.5
round drinkers	1.5	2.0

(Oyster) *shell* should be available in a special feeder all the time. One feeder per 100 birds.
Insoluble *grit* (gravel) should also be available all the time. One feeder per 100 birds.

If *automatic equipment* is present (for feeding, water supply, for lighting, switches), check **daily** whether everything is in order; replace worn-out parts without delay.
Make sure that the farm never runs out of feed - this could turn out to be financially catastrophic.

Weigh the daily feed supply accurately each time, since both excessive feeding and insufficient feeding are costly.

Catching fences, a hook and scales are needed to weigh a representative sample of the birds *every four weeks*.

Dead (diseased) birds should be disposed of in a closed container - they should be burnt in an incinerator.

Birds coming into lay too early (before being sufficiently mature) suffer at times from protrusion of the cloaca (cloaca sticks out) or from egg binding.

Treatment of individual birds (if detected in time) by steaming the cloacal area is sometimes successful.

There is a real danger of losing the bird when other hens start to peck at the protruding cloaca, as this usually results in heavy bleeding and permanent damage.

Everything should be done to avoid hens coming into lay too early!

It is important not to supply antibiotics to stimulate egg weight and egg production during the first months of egg laying or to change to layers' feed too early.

Note: for further information, for instance on laying nests, see Chapter 2.

5.4 Culling and selection

The term 'culling' is mostly used to indicate that we remove from the flock, and discard, any chicken that is inferior in appearance or production, that is sick or is likely to become sick and that threatens to endanger the profitability of the flock.

The term 'selection' has a more positive meaning: we select the better bird for use in a breeding programme.

Culling may start as soon as the young chicks arrive at the farm. Any day-old chick that shows one of the following defects has to be culled (and should be discarded since it is not profitable and may even be dangerous to keep it):

- deformities like crooked legs (curly toes), only one eye or a crossed beak
- unhealed navels (because they are a source of infection)
- dehydration i.e. too much body moisture has been lost; this condition is difficult to correct
- colours not (quite) representative for the breed i.e. the bird is not genetically true to type; this is more serious in breeder birds than in commercial egg layers
- the bird makes a dull impression (is not lively), with sunken head and drooping wings; this indicates that the chick does not feel well and may already be sick

During the *growing period* we remove any bird that does not keep pace with the others; for instance it is too light in weight, it has crooked legs or other deformities, it has been badly damaged (cannibalism) or it shows signs of illness.

When such a bird is noticed, it should be removed *immediately*. If such birds are left in the flock, in particular the weak birds, they become a potential danger to the health of the whole flock, because the easiest way for any disease to enter the flock is through the weak birds.

Just before the laying period a selection is made of the hens which are good enough for the laying house. In breeder birds this selection is more rigorous than in commercial laying hens. Inferior birds

should never be left in the flock. One may be inclined to think that inferior birds will recover but this is seldom the case.

Good hens:

- are lively and interested in what happens around them
- yellow-skinned breeds have strikingly yellow-coloured beaks and shanks (if sufficient xanthophyll-containing feeds are supplied)
- have smooth and nice-looking feathers in the colours of the breed (important for breeder birds)
- have bright red and fully-grown combs and wattles
- have the right bodyweight (neither too heavy nor too light)

For meat-type and medium-size hens used for broiler production, selection should be based on weight at 8 weeks as this gives an indication of the weight of their offspring at the age of slaughtering - so keep records.

During the laying period several changes occur in the hen. After about two months of laying the good and the poor layers can be distinguished from each other, as shown in the following table.

This table can be used at all times, but the average condition of the whole flock should be taken into consideration.

Selection is strict when meat prices are high and egg prices low, and vice-versa.

Moulting should not take place before 11-12 months of laying.

Table 18: REFERENCE CHART showing some differences between good and poor laying hen

Feature of hen	Good	Poor
comb and wattles	large, red, full	dry, pale, scaly
eyes	keen and sparkling; in most breeds an orange-coloured pupil	sunken, dull, irregular form of pupil, abnormal colour
beak	short, colourless	long, yellow in non-laying hens
feathers	shiny and still beautiful	rounded, lustreless; later tail feathers broken
moulting*	late and rapid; hen lays during moulting	early and slow; hen does not lay during moulting
distance from breast bone to pelvic bones	plenty of room; width 3-4 or more fingers according to the breed	narrow; width 2-3 fingers
distance between the pelvic bones	plenty of room; width 3-4 fingers	narrow; width 1-2 fingers
weight	normal, according to the breed	too heavy because of too much fat, or too light due to illness
skin	smooth and warm	hard and dry
cloaca	oval, fleshy colour, large and moist	small, round, yellow, dry
claws on toes	short	long
colour of the shank (in yellow-skinned chickens)	colourless (yellow colour has disappeared)	yellow
belly (abdomen)	normal, soft, smooth	too big or too small, dry, hard; hard
objects in intestines		may be felt

* Partial moulting, in particular of the neck feathers, should not be confused with real moulting; the neck feathers may wear out due to frequent entrance into the laying nests - these are good layers!

5.5 Daily routine jobs in the chicken house

How to enter the chicken house:

- change clothing (put on a clean dust coat) and disinfect foot-wear
- wash hands
- knock on the door of the pen before entering
- speak in a quiet low voice
- enter quietly and avoid sudden movements

How to catch a single bird out of the flock:

- DO NOT RUN after a chicken
- select a chicken standing near by, preferably with its tail towards you
- stretch your hand out slowly to one of its legs and catch it (use a hook if the bird is too far away)

How to carry a bird:

- hold both wings, near the body of the chicken, with your left (or right) hand
- keep the bird sufficiently far away from you that it cannot scratch you with its legs
- most chickens drop some manure after having been caught

Table 19: Checklist of daily routine

Feeding	How much feed per chicken? <ul style="list-style-type: none"> ➤ depends on age, size and purpose ➤ is found in tables, graphs
	How to feed? <ul style="list-style-type: none"> ➤ inspect previously given feed (consumed or not) ➤ if not consumed, adjust amount accordingly ➤ remaining feed to be pushed to one side (straight feeders) ➤ fill the feeders to approximately 1/3rd, not more; if filled to more than 1/3rd, up to 20% is wasted ➤ add feeders if there is not enough feeding space
	What to feed? <ul style="list-style-type: none"> ➤ fresh and nice-smelling feed ➤ correct for the purpose for which it is intended ➤ be sure of ingredients
	Type of feed? <ul style="list-style-type: none"> ➤ dry mash (and grain) ➤ wet mash ➤ pellets or crumbs ➤ mash and scratch
Drinking equipment	<ul style="list-style-type: none"> ➤ wash drinkers daily and scrub with brush ➤ add a mild disinfectant to the washing water ➤ rinse with clean water ➤ fill drinkers or reservoir and check whether the system is working as it should; adjust if necessary ➤ put drinkers above dropping pit (if possible) ➤ avoid spilling water
Changing disinfectant	<ul style="list-style-type: none"> ➤ clean small buckets daily ➤ wash and brush and put in fresh disinfectants as prescribed ➤ clean entrance bath weekly or more frequently if needed ➤ drain bath and wash and scrub ➤ fill bath and disinfect as prescribed
Egg collection	collect eggs several times per day, e.g.: <ul style="list-style-type: none"> ➤ 1st collection 3 hours after sunrise ➤ 2nd collection 5 hours after sunrise ➤ 3rd collection 7 hours after sunrise ➤ 4th collection just before sunset or more often if necessary
Egg selection	<ul style="list-style-type: none"> ➤ select eggs according to grade; e.g. A = large, B = medium, C = small and whether broken or dirty and according to use (hatching or consumption) ➤ wipe dirty eggs clean, with a soft cloth ➤ dirty eggs are for immediate consumption; this also applies to cracked eggs ➤ beat contents of broken eggs (if clean) with a fork, put in container and store in freezer
Supply green feed	<ul style="list-style-type: none"> ➤ hang green feed just above the heads of the chickens; this will keep the chickens busy (jumping) or, alternatively: ➤ cut alfalfa (or other green fodder material) into small pieces (2-3 cm) and divide over feeders around noon
Supply grit	<ul style="list-style-type: none"> ➤ necessary for the proper functioning of the stomach ➤ keep containers filled ➤ use correct size
Condition of the litter	<ul style="list-style-type: none"> ➤ replace or add litter as required ➤ keep litter loose by raking ➤ caked and muddy parts should be removed immediately
Inspection of flock	<ul style="list-style-type: none"> ➤ first thing to do when entering poultry house after absence for a longer period ➤ check behaviour (anything abnormal?) ➤ remove dead birds immediately ➤ remove and/or separate sick or damaged birds
Records	keep daily records of: <ul style="list-style-type: none"> ➤ feed consumption (amount and type) ➤ egg production (if applicable) ➤ removed birds (dead, sick + cause, sale) ➤ vaccination ➤ medication

5.6 Records to be kept

Records are extremely important in poultry keeping. Many management decisions are based on records. Records are used to compare results with set standards; in this way they give information about how well a poultry business is going.

Roughly speaking two types of records are distinguished:

- 1 Primary records: these records are kept daily
 - for instance quantity of feed consumed per pen per day
 - number of eggs collected per day
- 2 Summary records: these records are based on the primary records
 - for instance total feed consumption for a certain period
 - total egg production for a certain period
 - mortality in a given period

After the relevant information (data) is taken from the primary records and correctly entered into the summary records, the primary records may be destroyed.

Summary records are kept and used for further reference.

Make sure that for each record taken the following is identified:

- the batch of chickens concerned (e.g. 1996-1)
- the house or pen concerned (e.g. house no.3)
- the breed of chickens (e.g. R.I.R.)
- the source from which the chickens came
- the hatching date (e.g. 1-11-1996)
- the housing date (e.g. 3-11-1996)
- the 5% production date, for layers only (e.g. 15-3-1997)
- the number of chickens started (e.g. 150)
- the number of chickens at the beginning and at the end of the record period
- the period concerned (from (date) to (date))
- for primary records, the period usually taken is 4 weeks; summary records usually cover either the full life cycle of a laying hen (generally 18 months) or part of it (e.g. growing period or laying period)

A *most important rule* in record keeping is WRITE NEATLY. Records which cannot be read afterwards become useless and may give rise to mistakes.

The following records are usually kept:

Table 20:

Primary	Summary
<ul style="list-style-type: none"> ➤ house list rearing period ➤ house list growing period ➤ house list egg production period ➤ egg grading list 	<ul style="list-style-type: none"> ➤ rearing period summary ➤ growing period summary ➤ egg production period summary ➤ egg grading review

Other records that are useful:

- Flock history report for laboratory diagnosis (to be sent with dead/diseased birds to the laboratory)
- Medication report (to record any medication given to the flock)
- Vaccination report (to record all vaccinations given to the flock)

Some *worksheets* that are commonly used in poultry farms are:

- average weight of chickens per breed/sex/pen and week
- stocklist of animals per breed/sex and pen - to be kept monthly
- feed allocation per chicken per day and per pen - as a reference for those who are responsible for the feeding

- feed mixture - the ingredients and the quantities to mix
- feed order sheet - to order feed or feed ingredients from the supplier
- stocklist of poultry feeds - to keep a check on stock of feeds and to see at a glance when to order again
- stocklist of equipment
- duty list - to avoid any confusion between personnel; everyone has his or her task clearly written down

Many other records/worksheets can be designed according to need, BUT DO NOT TRY TO KEEP (TOO) MANY RECORDS as this will be confusing.

5.7 The egg

The diagram shows the chicken egg sectioned lengthwise.

The diagram shows the *yellow yolk* with the white yolk in the centre. The white yolk is connected with the *embryo*. The density of the white yolk is lower than that of the yellow yolk and for that reason the white yolk with its embryo lies at the top.

The *yolk membrane* (yolk sac) with its *chalazae*.

Around the yolk lies the 'white' of the egg, consisting of thick and thin white. The white is surrounded by two membranes lying close together.

The *shell* has many pores which permit the entry of air and the evacuation of water vapour and carbon dioxide (CO₂); this is important in view of the respiration of the chick in hatching eggs.

The egg *cuticle* is slimy before the egg is laid but it dries to a powdery layer once the egg is out. The cuticle blocks most pores but permits the passage of gases. In this way the egg does not dry out too rapidly and the cuticle prevents the entry of micro-organisms (not 100%).

Lastly there is an *air chamber* between the two membranes that surround the white, at the blunt end of the egg. The air chamber comes into being when the egg cools down after it has been laid. Generally it becomes larger on storage because the egg loses moisture.

5.7.1 Egg quality

Grading and *standardization* mean arranging (agricultural) produce into a number of uniform categories according to physical and other characteristics which are of economic importance.

Consumers are generally willing to pay a higher price for a uniform batch of high-quality eggs.

Broken (cracked) eggs spoil more quickly than unbroken eggs and should be sold to customers who use the eggs at once.

Spoiled ('rotten') eggs are a danger to human health. They should in any case be detected before they reach the market.

Exterior quality

First class eggs are clean and normally shaped. Eggs with an abnormal shape (too long) or shell (rough surface, thickness not the same everywhere) should be separated from the lot and considered as second class eggs.

The strength of the egg shell (0.3-0.4 mm thickness) is affected by heredity, nutrition (Ca, P and vit.D) and management (egg handling, cage construction).

The condition of the shell can be checked by gently tapping two eggs together

(= 'belling'). A dull sound instead of a clear clinking indicates a cracked egg. Hair cracks only show up on candling (see below).

Brown eggs usually fetch a higher price but the colour of the shell has no influence on the quality of the egg or its shell.

Interior quality

The most accurate method of testing interior quality is to open the egg on a flat glass surface and observe the appearance of the yolk and the white. This is then compared with a standard (e.g. illustrated on a wall chart) authorized by a marketing board.

This testing method can only be applied on a sample basis.

Candling is the only way of testing eggs without breaking the shell. The egg is inspected before a candling lamp which provides a light beam sufficiently strong to penetrate the shell and illuminate the contents.

Various types of candling lamps are used but the essential features are the same: a light beam emerges through a circular opening about 3 cm in diameter.

The egg is held very close to the opening of the candling lamp; the blunt end of the egg is held against the light with the axis at a 45° angle.

The egg is twirled round (= circular motion) to make defects appear which otherwise would have remained unnoticed.

The beginner will soon be able to detect defects like cracked shells, blood spots and advanced stages of rotting, but a *considerable amount of training* (practice!) is needed before internal quality can be judged with reasonable accuracy.

The main *quality points* to observe in candling:

The internal quality an egg is mainly based on the visibility, the ease of movement and the shape of *the yolk*; sided, stuck, uneven in colour, abnormal shape, discoloration due to specific ingredients in the feeds, embryonic development where eggs are not collected frequently enough from nests in hot climates, are all faults;

The quality of *egg white* is judged by the degree of movement of the yolk and the definition of its outline. Faults in the white are discoloration and cloudiness.

The *depth of the air chamber* is a rough indication of the age of the egg and there is often a relation between this depth and the interior quality. But this is not always the case, since freshly laid eggs may be of low interior quality and eggs stored at high temperature and humidity may not have lost much water but may have deteriorated considerably.

Other **defects** are:

Bloodspots

Clots or streaks in the white or adhering to the yolk which can be distinguished from meat spots by their definite pinkish colour; usually easily detected (in a 'blood egg' blood is diffused throughout the white or spread around the yolk).

Meat spots

Floating freely in the white, embedded in the chalazae or attached to the yolk.

Staleness

Abnormally large air chamber in most cases.

Mould growth and rot

Usually definite (violet, green, red or blue) coloration; such eggs even when unbroken often have an unpleasant smell.

Note:

It goes without saying that eggs infected by harmful bacteria such as Salmonella go unnoticed by candling alone. Salmonella present in litter may penetrate into the egg.

5.7.2 Grading of table eggs according to weight or size

Market returns are generally improved when the different types and sizes of eggs each find their appropriate market outlet.

A simple device can help in grading eggs according to size. It consists of a piece of plywood with holes of different sizes:

Table 21:

Ø 43 mm	Ø 40 mm	Ø 37.5 mm
> 60 g will not pass anywhere 50-60 g will just pass here but not elsewhere	40-50 g will pass here but not through the smaller hole	eggs < 40 g remain

Naturally, sophisticated automated equipment is available for grading eggs according to weight (namely endless belts over different scales, each scale set at a specific weight). Sometimes a candling area is fitted with such an automated egg-weighing machine.

Table 22: In the European Union EU the following egg weight classification is in use

Classification	Weight
S = small	< 53 g
M = medium	53-63 g
L = large	63-73 g
XL = extra large	> 73 g

5.7.3 Chemical composition of the chicken egg

An egg of 58 g consists on average of:

11% shell including shell membrane

57% egg white

32% yolk

Heavier eggs usually have more white and relatively less yolk.

Roughly speaking, in all eggs the weight proportion is 6 (white): 3 (yolk): 1 (shell).

Table 23: Chemical composition (approx.)

	total egg	white	yolk
water	65.5%	88%	49%
protein	12	10.5	16.5
fat	10.5	-	32.5
carbohydrate	1	1	1
minerals	11	0.5	1

The yolk is richer in nutrients than the white, specifically with regard to fat.

The protein content of the yolk is higher, but the greatest part of the protein in an egg is in the white.

6 Management of breeder flocks (= parent stock)

The production of hatching eggs requires management practices that are also required for the production of commercial table eggs. But there is an important difference: now we need eggs that have also been *fertilized* and that will *hatch well*.

For the rest many of the practices that have been discussed in Chapter 5 'Management of laying stock' are also valid here.

Farm isolation

Usually breeding birds are subject to some kind of disease-free programme:

- Pullorum
- Mycoplasma gallisepticum (Mg)
- Mycoplasma synoviae (Ms)

The *isolation of the breeding flock* must be complete in order to prevent the entrance of disease from outside: use separate personnel and the persons involved must shower and put on clean clothing before entering the premises.

The permanent breeding quarters are also used for the brooding and growing period of the breeders. There is no transfer from one house to another; this eliminates stress due to transfer and reduces the risk of an outbreak of Mg and Ms.

Conditions in the breeder house

A *concrete floor is required*, because such a floor is more sanitary and easier to clean.

Breeding birds are given *more floor space* per bird than commercial egg laying hens; as indication (adult birds):

Table 24:

Type of bird (male included)	litter		wire/slats and litter (1/3-2/3)	
		birds/m ²		birds/m ²
Leghorn type		6		7
Medium size		5		6
Meat-type		4.5		5

Note that all-wire floors are not used in breeder houses because hens do not like to be mated on wire.

Feeding space (indicative):

Table 25:

	Leghorn	Medium	Meat-type
Straight feeders	10 cm/bird	12 cm/bird	15 cm/bird
Round feeders	5 cm/bird	6 cm/bird	7.5 cm/bird

Drinking space:

Table 26:

	Leghorn	Medium	Meat-type
Straight drinkers	2.5 cm/bird	3 cm/bird	4 cm/bird
Round drinkers	1.5 cm/bird	2 cm/bird	2.5 cm/bird

Nests: provide one nest for every four hens; meat-type birds need larger nests than smaller birds.

Light: in environmentally controlled houses a lighting schedule should be kept, for maximum hatching egg production.

In other cases a lighting schedule may be kept adapted to the natural length of the day.

6.1 What should have been done before breeding starts?

At the end of the growing period of the breeders the following matters should have received attention already. When the production of hatching eggs has started, it is *too late* for these measures:

- 1 proper vaccinations
 - vaccination schedules for breeder birds are different from commercial egg laying birds
 - blood titers should have been checked
- 2 debeaking; female breeders should have been debeaked
- 3 6-8 week selection; in meat-type birds the smaller males and females are removed at this stage
- 4 mature selection; just prior to the onset of egg production, males and females of poor quality are removed from the flock
- 5 if sexing errors are discovered, remove the birds concerned immediately, at any time
- 6 internal parasites; if worms were present during the growing period, an effective eradication programme should have been carried out - allowing the birds to start their breeding period free of worms
- 7 Mg, Ms and Pullorum negative; just before or immediately after egg production starts, the cockerels and the hens should be bloodtested
- 8 correct mature body weight
 - the feeding programme during the growing period should have been such that it produced a specified body weight at sexual maturity

Again, the above should have been done or accomplished during the growing period. REMEMBER: ONE CAN HURT, BUT NO LONGER HELP A 21-WEEK OLD CHICKEN!

6.2 The importance of correct body weight

Breeder birds should have the right body weight when they reach sexual maturity; therefore they should be weighed, at least every two weeks. In particular, medium size and meat-type birds have a tendency to develop too much body fat. For these types the body weight should also be controlled during the period of egg production.

Good body fleshing but without excessive fat is desirable for the following reasons:

- onset of egg production is delayed
- first eggs are larger
- egg production during the laying cycle is increased
- more hatching eggs are produced (because the eggs will be of a larger size)
- laying house mortality is reduced
- feed cost of growing pullet to sexual maturity is lowered
- feed cost of producing a hatching egg is reduced
- fertility of the hatching egg is increased
- hatchability of the hatching egg is improved

If the breeder birds are fed to appetite during their growing period, they may be too heavy at sexual maturity and may not produce the possible maximum number of eggs during the laying cycle.

Feed allocations should be made with the aim of obtaining the recommended body weight for the particular type of bird concerned. There are *no set rules*: follow the instructions of the breeder of the birds.

To *check* the body weight, females should be weighed once every two to four weeks during the laying cycle.

Weigh a representative sample of the hens in each pen.

Weigh a sample of the males too.

6.3 Measures to improve fertility

About 4 weeks before reaching sexual maturity (i.e. at about 18 weeks of age), the males should be placed with the females. Do this late in the afternoon, as this will reduce fighting; fighting will occur for about half an hour in this case, until sunset (the next morning it is over).

Too many males in the breeding pen reduces fertility; not enough males has the same effect. The ratio is about 1:10; slight deviations may be useful depending on the breeds involved, as is shown in the following table (indicative only).

A few *extra* males should be placed in the pens at the time when the cockerels are introduced to the hens, to allow for some early culling and mortality from fighting. But remove them as soon as the flock seems to have come to rest.

Table 27:

Males	Females	Product	Males per 100 females
White Leghorn	White Leghorn	White Leghorn type	8
Medium size	Medium size	Medium size type	9
Meat-type	Meat-type	Meat-type	11
White Leghorn	Medium size	Hybrid layer	8
Medium size	White Leghorn	Hybrid layer	9
Meat-type	Medium size	Broiler	11

- Males mate between 20-80 times a day. During hot weather cocks have a reduced sex drive, which may result in no significant fertilization of eggs at all. Most matings take place in the cooler part of the day (early morning).
- Fertile eggs will be produced for days after the males are removed from the flock; but if males are removed and new males added to the flock the same day, the fertile eggs produced after three days will be the result of matings by the new males.
- Excessive body weight of the male at maturity must be avoided.
- Any inferior looking male should immediately be removed (catch by both legs).
- Exercise the males: strew a little grain in the litter, several times a day.
- Use proper equipment for the males. Often feeders and drinkers are inadequate for cocks. Place special feeders for cocks if their body weight is too low. Place them higher so that only the cocks can reach them.
- The timid male. In males as in females there is a certain social order. A timid male may not receive enough feed. Make sure that there is enough feeding space.
- When cocks have sore feet they will not mate. Treat immediately.
- Males not mating. On a partly litter floor, males will show a tendency to remain on the wire/slats, as a sort of 'roosting' place. Hens prefer to be mated on the littered part. Strewing a little grain in the litter will cause the males to come down.
- Age of breeders: cockerels (young males) give better results than older cocks. It is not advisable to use males above two years of age.

Light during the egg production period stimulates the production of eggs and also increases the quantity and the quality of the semen of the males. Apply a specified lighting schedule.

6.4 Hatching egg production

The only purpose of keeping breeding birds is to produce an *abundance* of hatching eggs that will give a *high* percentage of *quality chicks*.

The following management practices are important for the production of hatching eggs:

Nesting material

Hatching eggs are valuable and egg breakage is costly. Therefore abundant nesting material should always be available. It should have the following properties: absorbent, durable, coarse so that it will not easily be blown from the nest, dust free, good cushioning quality and inexpensive.

Useful nesting materials are wood shavings, groundnut hulls, rice husks, chopped corn cobs, straw and hay.

Floor eggs

The breeder hens should be trained to use the nest rather than the floor on which a high percentage of the eggs laid will be broken. Floor eggs are also less suitable for hatching. To induce hens to lay their eggs in the nests:

- place the nests in the pen before the birds start laying
- put the nesting material in the nests at the time the nests are placed; keep the nesting material clean before egg production starts
- if roll-away nests are used, put nesting material in them before and during early egg production; hens refuse wire-floored nests
- provide adequate nesting material; if the material has been blown out of the nests, or if it is wornout, with bare surfaces showing, the hens are not likely to lay eggs in the nests
- block off corners of the pen where hens congregate and are likely to lay eggs on the floor; do this before egg production starts
- make sure that there are enough nests; if a hen cannot find a nest in which to lay an egg, she will be forced to find a 'nest' on the floor
- disperse broody hens as they take up nesting space, forcing other hens to lay eggs on the floor

Collecting hatching eggs

Hatching eggs should be collected from the nests at least 4 times per day; in extreme temperatures 5-6 times per day. Frequent collection decreases breakage and helps to maintain the hatching potential.

It is important to collect the eggs that are laid late in the afternoon on the same day. Hatching eggs left in the nest overnight will lose some of their hatching qualities.

Suggested time schedule for the collection of hatching eggs, under a natural daylight programme:

- 3 hours after sunrise (e.g. 09.00 hrs)
- 4 hours after sunrise (e.g. 10.00 hrs)
- 5 hours after sunrise (e.g. 11.00 hrs)
- 6 hours after sunrise (e.g. 12.00 hrs)
- 7 hours after sunrise (e.g. 13.00 hrs)
- 11 hours after sunrise (e.g. 17.00 hrs)

Close the nests at night and open them again early in the morning, before egg production starts. Do not allow hens to sit in the nests overnight and remove any hen found in the nests, to prevent broodiness.

Egg containers

- use only plastic egg flats (key-trays)
- never use a bucket or basket because eggs piled on top of each other will break and cannot cool down
- place the eggs with the narrow end down
- when collecting eggs, separate the extra large/double yolk/misformed & cracked eggs from the normal ones
- do not carry more than 2 egg flats on top of each other unless a special carrying device is used
- disinfect and fumigate egg flats after use

The hatching eggs should be *fumigated* as soon as possible after collection.

Storage time should be as short as possible. At 2-3 days after laying hatchability decreases.

For short periods (up to 4 days) hatching eggs should be *stored* at 18-20 °C. For longer storage periods, the eggs should be stored at 18 to 14 °C; longer than ten days at 12 °C. Try to maintain a relative humidity of 80% or more.

Selection of hatching eggs

Hatching eggs should be first-class, fertilized eggs.

There is no way yet of checking the fertility before incubation, but the practices outlined below will help to eliminate possible failures.

Guidelines:

- do not include dirty floor eggs
- only first class eggs should be used; all eggs with obvious abnormalities should be rejected
- misformed eggs do not hatch well
- broken or cracked eggs are useless because they dry out inside the incubator
- small eggs usually give weak chicks
- long eggs are mostly 'double yolks' which will never hatch
- abnormally coloured eggs are usually the result of a genetic defect.

There are specific egg-weights for each type of chicken according to their production season, but in general a hatching egg should weigh between 52 and 70 g.

Handle hatching eggs carefully because they are costly!

REMEMBER: ANY DIRTY OR CRACKED EGG IS LOST AS A HATCHING EGG.

Vaccination

Breeding birds should produce parental immunity in chicks. To produce a constant degree of parental immunity it is necessary to *revaccinate* the breeder females for Newcastle Disease and Infectious Bronchitis at *intervals of 12 weeks* during the laying period.

See Chapter 8 'infectious disease and their prevention'.

6.5 Guidelines for the selection of breeding stock

The selection of males and females for future breeding stock should be based on the relative economic importance of each characteristic that is considered in the selection process.

Every hen selected for breeding purposes should be carefully examined.

The following is a list of desirable characteristics:

- 1 physical
 - good breed type
 - reasonably good plumage colour
 - free from defects
- 2 egg production
 - early sexual maturity

- high rate of laying
- non-broodiness
- no pauses (or only short ones) in egg laying
- persistence of production

3 egg quality

- standard egg size
- proper shape and colour
- uniform shell texture
- high % of thick albumen
- no blood spots etc.

The above characteristics can most easily be checked by trapnesting the birds. An individual check for each bird will give information. Trapnesting for 3 consecutive days per week gives enough information. The other 3 days can be used for trapnesting another flock or for doing any other job. This will save time and labour. Trapnesting is usually done over a period of 300 days.

Checks every 4 weeks and individual hen recording will give sufficient information.

4 hatchability

- high fertility
- high hatchability
- quality chicks

Incubation and hatching records will give information.

5 viability of growing stock and layers

- low mortality %
- low culling %

Any bird still present at the age of 12-15 months will have a rather high resistance to diseases and/or other unfavourable conditions. The collection of eggs for future breeding stock should therefore not start before this age.

6 meat production

- rapid growth
- early feathering
- superior breast fleshing
- good body size

Body weight at 6-8 weeks of age gives a good indication of the weight of the offspring later on. There is little correlation between body weight at sexual maturity and the weight of the offspring.

Selected birds (at 6-8 weeks) should be checked at marketing time (9-14 weeks) on the following characteristics:

- feathering; full feathering is desired (pin feathers lead to discount in price when the birds are sold)
- breast fleshing
- body size

Each of the above characteristics has to be taken into consideration on the basis of its relative economic importance. For instance, selection on (a) has hardly any economic value and (f) is only important for meat-type breeders.

Note: the selection on feed consumption and conversion should be taken into consideration too, but these are very difficult to measure on the individual bird.

6.6 Recycling of the breeder flock

Breeder flocks used for the production of hatching eggs are often force-moulted and 'recycled'. The reasons for doing this are:

- to supplement normal hatching egg production
- to compensate for high mortality in the growers; if there is excessive mortality in the growing flock that is going to replace the present flock, the latter may assist a second time in the production of hatching eggs
- an unexpected heavy demand for chicks (the demand for day-old chicks is sometimes difficult to predict)
- for single-line breeders, recycling the flock (or part of the flock) is the most reliable method of improving the breed

Force-moulting can be achieved by one (or a combination) of the following methods:

- 1 Water withdrawal for one or two days, after which water supply is restored and then withdrawn for another two days. *Not* to be practised during *hot weather*.
- 2 Feed withdrawal for several days, or feeding an unbalanced ration (feed grains only).
- 3 Light withdrawal in environmentally controlled houses, well below 11-12 hours per day.

Any one (or a combination) of these methods will create stress in the birds, causing them to drop their feathers and lose weight. Hopefully not many of them will die.

After two days of depriving the birds of water and/or feed, a return is made to a skip-a-day programme (one day feed, the other day water) which is continued for one week.

After this a normal, controlled (restricted) feeding programme. After 60 days the light may be stepped up to 14-16 hours per day. Egg laying will resume.

Force-moulting a flock and recycling is only worthwhile if the quality of the flock is excellent. Only birds having desirable characteristics should be used.

In most cases it is advisable to add new males to the breeder flock because they are more fertile.

Note: it should be kept in mind that force-moulting is a difficult technique and it should not be taken lightly.

In a tropical climate moulting can quite easily take place *accidentally* too! For instance because of a heat stroke, watering failure or a sudden change in feed quality.

Accidental moulting always means a very serious economic loss.

7 Broiler and roaster production

A **broiler** is a small chicken used for human consumption. The maximum live weight is 1½ to 2 kg. A **roaster** is a much heavier chicken used for human consumption. The maximum live weight is 3 to 3½ kg.

7.1 Broiler production

The growth of the broiler industry has been phenomenal in many countries. Because the margin of profit per chicken is usually small, broiler production is often a large-scale enterprise. Thousands of chickens have to be reared by a single producer in order to make a reasonable income.

Requirements

Broilers are produced from special chicken breeds. Nowadays they are usually *hybrid birds*. Broilers are raised on *special feed*.

Broilers need *special housing and equipment*, in most cases heavily automated.

Broilers are grown in a *short period of time*, usually in 7 to 9 weeks.

The more the broilers are crowded, the poorer the results.

Indicative floor space of broilers and roasters, under tropical conditions:

Table 28:

Weight of marketable bird		birds/m ²
1.5-2 kg		15-12
2-3 kg		12-7
-		-
-		-
-		-

Usually broilers are kept on litter and this requires a *concrete floor* unless the soil is dry and porous (sand). Sand should be easy to replace or turn over at all times.

Most broiler houses hold not less than 10,000 birds, divided into pens. The number of birds per pen should not exceed 2,000.

The equipment used is the same as that for the rearing of young chicks although more automated.

Since broilers are normally some kind of hybrid bird, selection should be done on the basis of performance tests in testing stations.

There is not much difference between the top ranking groups.

Daily management

Broiler management might be called *micro-management* because it involves a lot of little things which as such seem insignificant but added together make for economic production. It depends on the farmer/manager/caretaker whether or not the business will be economically successful. If the management is careless, forgetting small things or does not know the business very well, the broiler enterprise is likely to be a failure.

The *preparation* of the house for the broiler chicks is the same as that for chicks reared for egg production. But the time between two batches is usually shorter, therefore the cleaning (+ repairs) of the house and its equipment should be accurately scheduled.

Special attention should be paid to:

Temperature

House temperature should be 32 °C at the start and thereafter is usually reduced by 3-4 °C per week until 20 °C at an age of 4 weeks. Under tropical conditions as low as possible!

Ventilation

The chicks grow rapidly to considerable weight. Very good *ventilation* is needed, to remove moisture and ammonia, to replenish the oxygen and to maintain an optimum temperature.

Under extreme weather conditions ventilation may become a problem, in particular in the last weeks before marketing.

Light

With broilers, light is only necessary to enable the birds to move about and see the eating and drinking places. Light intensity should be as low as possible, to keep the birds quiet which improves feed efficiency and to avoid feather pecking and cannibalism.

There are different lighting schedules for broilers, e.g. daylight with some hours of artificial light during dark hours. For closed houses every lighting schedule is possible, including intermittent lighting.

Cannibalism

Broilers should be debeaked at day-old *or* not be debeaked at all. If cannibalism develops there is hardly any treatment or remedy. In environmentally controlled houses one can make use of red light which seems to reduce cannibalism.

Using red light in open-sided or windowed houses makes no sense.

Disease prevention

With broilers, as opposed to birds raised for egg production, there is only a short growing period - too short for the birds to recover from most disease outbreaks before marketing time. Therefore disease control procedures must be directed at *disease prevention rather than treatment*.

There is no generally accepted vaccination programme. Some broiler producers do not vaccinate at all because they practise complete isolation and sanitation. This is not recommended. Vaccinations against Newcastle Disease ND and bronchitis IB are useful for broilers. These are mostly carried out at the hatchery.

Note: vaccination creates a stress, therefore be sure of:

- the right type of vaccine
- the freshness of the vaccine
- the directions for use (how to apply)
- the right time to apply the vaccine

When buying a vaccine *always ask for a leaflet* with detailed information about the vaccine, such as type of vaccine (live or dead, mild, intermediate or strong), the dosage for different ages, dilution rate, side-effects, contra-indications, how to store and transport the vaccine and vaccination methods. On the vaccine vials there should be a *sticker* with the name of the vaccine and the name of the company that produced it. There should also be a batch number on this sticker together with the expiry date of the vaccine.

Coccidiosis must be fully suppressed in broilers as there is no time for the development of immunity. Use a coccidiostat at full level in the feed. An outbreak of coccidiosis reduces the profit to be made on the flock. Quite often it will be necessary to medicate a flock of broilers to alleviate the stress created by disease or some management failure. Most drugs used in the course of

treatment must be withdrawn from consumption by the birds some time before the date the birds are marketed, in order to eliminate or reduce the amount of drug in the body tissue of the birds. Be sure to know the withdrawal period of each drug that is used.

Note: for further information, see Chapters 8 and 9, for instance the sections on immunity and vaccination, buying and storing vaccines, drinking water and eyedrop vaccination, coccidiosis and treating chicken diseases.

Records

Weekly records should be kept of:

- live body weight (samples)
- weekly increase in body weight
- weekly feed consumption + cumulative feed consumption
- weekly feed conversion + cumulative feed conversion
- mortality

Compare the results with known standards. Deviations should be traced and corrected if possible.

The study of the records will most likely show that:

- Males grow faster than females; the males attain a certain weight approximately nine days before the females.
- Weekly increases in weight are not uniform; gains increase weekly, until reaching a maximum at about 8 weeks. Females reach their maximum weight gain before males.
- Weekly feed consumption increases as weight increases. Each week the birds eat more feed than they did before.
- The first gains require less feed. Feed conversion is lowest (the most economical) in the first week, then increases each week thereafter (more feed needed per unit of weight increase).
- Males convert feed to meat more efficiently than females.
- The heavier the weight of the straightrun flock, the greater the percentage difference between the sexes.

Other findings may be:

- Larger chickens consume more feed than smaller ones.
- Healthy birds consume more feed and have a better feed conversion (less feed per unit of weight increase) than sick birds.
- Usually the more feed consumed, the better the conversion at a certain age.
- Exercise tends to reduce feed efficiency (more feed per unit of weight increase).
- Cannibalism lowers feed consumption and feed efficiency (ditto).
- Very high temperatures reduce feed consumption and cause a poorer feed efficiency.
- Growth and feed efficiency are poorer during cold weather because a greater portion of the feed is used to maintain body temperature.

Catching the birds at marketing time

Recommendations:

- allow the feeders to get empty 8-10 hours before slaughtering
- catching should be done at night (open houses); use dim light during catching so that the birds will be less disturbed. The use of dim blue or red light will enable the catchers to see the birds whilst the birds cannot see them
- remove all possible obstacles in the pens: otherwise birds that try to escape the catcher will damage themselves and cause economic losses (condemned meat)
- catch the birds by both feet and do not carry too many birds at a time
- do not overcrowd the crates used for transporting the birds; 20 birds per crate of 0.2 cubic metre (87 × 63 × 35 cm)
- load the crates onto the transport truck with care

- make sure that there is enough ventilation in between the transport crates (15 cm between rows)

7.2 Roaster management

In some places consumers prefer a heavier fowl than the broiler. Roasters are young birds grown to a weight between 2.75 and 3.75 kg in about 16 weeks.

Roasters are reared just as broilers but to a heavier weight. The management is the same until they reach approximately 2.0 kg body weight. After this a few changes are made:

- 1 More floor space is required, because the birds grow to a heavier weight; see table on page 97. Stick to the figures used for growing pullets.
- 2 More feeder and waterer space is required: feeder space 10 cm/bird after 8 weeks of age and waterer space 5 cm/bird.
- 3 More ventilation is required.
- 4 Adjust feed consumption if necessary. Sometimes light is given day and night to increase appetite.

Production of cockerels from straightrun flocks

Cockerels from medium size straightrun flocks can, after sexing (at about 6-8 weeks of age), be fattened for meat production.

8 Infectious diseases and their prevention

8.1 Production hygiene

Decisions with regard to the hygienic conditions on large-scale chicken farms are taken *at three levels*:

- 1 At the planning level, at the time when the farm is planned and set up - by the owner (long-term decisions).
- 2 At the farm organisational level - by the manager (medium-term).
- 3 At the operational level, in the day-to-day running of the farm - by the attendant(s) (short-term).

Small-scale chicken farmers are operating at all three levels.

'Hygiene' means first of all *the fight against pathogens*: no entrance, no spread, no accumulation of pathogens. Secondly, the resistance of the birds against pathogens that should be built up.

re 1. Planning

the location (mainly related to isolation):

- neighbouring farms
- area, size, local climate
- infrastructure: roads, electricity, water, availability of feeds, equipment, daily supplies, advice, veterinary assistance

type of enterprise:

- type of birds, number, age-groups; all in/all out is the ideal situation
- preferably no other species of animals

situation of the farm buildings, layout:

- size, capacity, distance between houses
- wind direction: ventilation, spread of pathogens to other houses
- paved, smooth roads which can be cleaned
- fence, gate, entrance (disinfection)
- parking place outside
- planting trees around to prevent entrance of pathogens by the wind; shade

type of housing (mainly related to contamination pressure):

- bedding, slatted floor, combinations, batteries
- ventilation, light
- manure disposal system: flies, spread of pathogens
- roof (insulating material to prevent heat build up)
- floors: smoothness, cracks, slope, drainage
- prevention of entrance: rats, mice, birds, people (locked door)
- feeding system, feed storage
- watering system
- equipment: should be easy to clean and to dismantle, should not hurt the birds
- entrance facilities, special room for large houses
- facilities for sick and weak birds

re 2. Management

choice of personnel; should not have birds at home

training of personnel, instruction, motivation, work clothing and personal hygiene

advising the owner; being up-to-date oneself

planning, supervision of the daily work

choice of supplies:

- birds, from one farm; density (number)
- feeds, daily supplies, disinfectants
- veterinary assistance, advice
- hygienic origin and transport of all supplies

control:

- feed consumption, water, production data
- administration

farm hygiene:

- each house own equipment, easy to clean
- vaccination scheme
- periodical health checks: blood titres, laboratory examinations, esp. coccidiosis in broilers
- sick animals: rapid diagnosis and treatment
- dead birds transported in packed condition
- precautions with regard to visitors
- no hobby birds on the farm
- only entrance of clean, disinfected supplies
- transport of birds with clean, disinfected (own) vehicle, packing materials, people
- no kitchen waste in the farm

re 3. Daily care

strict farm routine:

- birds are animals of habit; stress prevention
- quiet birds reduce the dust content of the air

(twice daily) *health control:*

- 1 behaviour, appearance of flock and individual birds, if necessary examination
- 2 intake: feed, water
- 3 output: production, droppings, dead birds
- 4 periodical checks

animal care:

- clean water, clean waterers
- clean feed, clean feeders, no old feed rests
- temperature, ventilation, air composition
- bedding, manure disposal, fly control
- immediate separation of weak and sick birds
- execution of treatments
- reporting abnormalities immediately

farm hygiene:

- keeping everything clean, well-arranged and maintained
- maintenance of disinfection bowls, etc.
- control on hygienic entrance of people
- prevent entrance of dogs, cats, children, birds
- control the hygiene of everything that enters the farm
- control of rats and mice
- maintenance of the farm area
- immediate cleaning and disinfection of the house after disposal of a flock
- routine examination of dead birds

routine administration:

- feed, water, production, mortality, incidents

periodical activities:

- vaccination
- preparation related to reception, delivery and transport of birds
- routine checks of (ecto-)parasites once a month

8.2 Flock observation and health control

There are several reasons why one should *regularly and closely observe a chicken flock*:

- 1 Observation is the *contact* we have with the birds. The birds can only ‘talk’ to us through their behaviour. When something is wrong (husbandry practice; health), they will tell us.
- 2 In case of disease outbreaks, these should be noticed by us *as early as possible*. Only in the *beginning* can losses be limited by treatment.
- 3 Most diseases are *subclinical*. Only *intensive* observation can lead to discovery.
- 4 *Weak birds* have to be noticed as soon as possible and they should be removed immediately. They cause high infection pressure and with early removal they may still be consumable.
- 5 *Non-productive birds* eat and ask services but do not ‘pay’ for that. One could say that non-productive ones eat the profit of the productive birds. Early removal is essential.
- 6 *Without observation skill there is no husbandry skill*.
- 7 Observation should lead to *decision-taking*. Observation is an important source of knowledge.

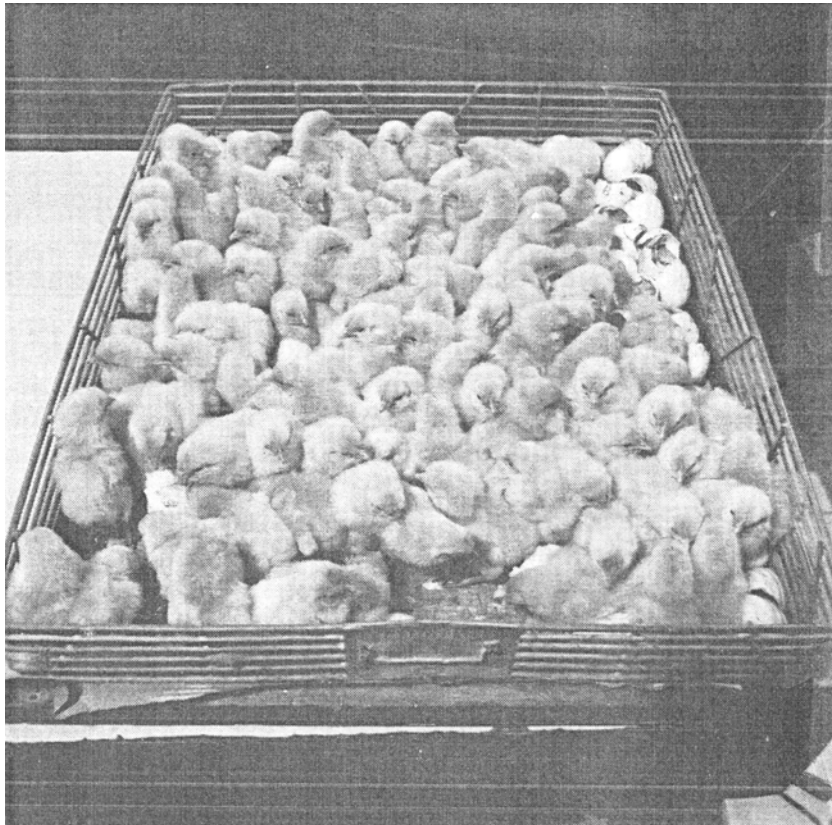

Figure 48: It is the health of the flock as a whole that matters



Figure 49: A diseased chick

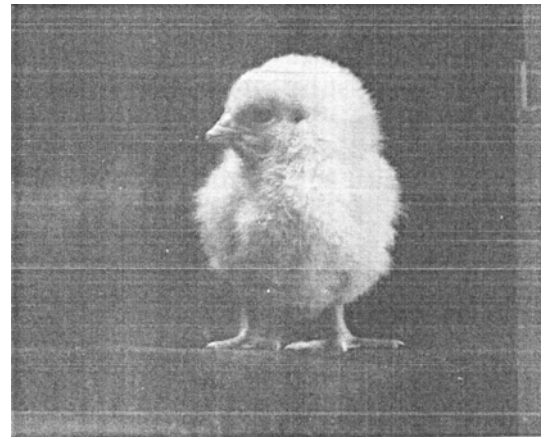

Figure 50: A healthy chick

When should the birds be observed?

- at least two times every day, during normal care
- when we have time to enjoy looking at them (as owner or otherwise)
- when we expect or suspect problems
- at certain events (some routine):
 - during individual vaccinations
 - when the birds are moved to battery or floor pens
 - before and after moulting
 - during and after disease outbreaks
 - once a month when ectoparasites are checked

‘Observing’ is using our sense organs, in combination with our intelligence and experience. It is mainly a question of *seeing*.

Noticing everything during an observation round is an art that needs (much) practice.

All husbandry practices are processes with four phases (as in any other productive mind process):

- 1 observation; helped by motivation, experience and common sense
- 2 judging; distinguishing the essential points
- 3 decision-taking; making a plan of operations
- 4 the execution of a plan; doing something and doing it well

Then follows the observation of the result(s), judging, etc.

Husbandry practice includes *making choices*; this is more difficult than to apply or reject all possibilities.

Observing a weak bird and doing nothing is poor husbandry practice.

The five basic points in *routine health observation* twice daily are:

Intake:

- feed and water consumption of the flock (including grit, shell, green plants)
- a change in water consumption is often a warning

‘Output’:

- droppings
- eggs (quantity and quality)
- dead birds; a rise in the death rate is the surest sign of real trouble

Behaviour of the flock, including the ‘talking’.

Appearance of the flock (mainly skin and feathers).

Routine checks and routine data: growth rate, feed conversion rate, mortality rate.

The above should be visible, controllable or available, otherwise the standard of husbandry is necessarily low.

Chickens are healthy when they behave according to norms. They are probably sick when they deviate from the norms.

In case of suspicion, *individual birds* are observed and examined. To get good results it is necessary to work along a fixed sequence; the following is convenient:

- 1 behaviour
- 2 body temperature
- 3 condition
- 4 skin and its appendages
- 5 circulatory system
- 6 respiratory organs including the eye mucous membrane
- 7 digestive organs
- 8 uro-genital organs
- 9 locomotive organs
- 10 nervous system and sense organs

This sequence is discussed below.

re 1. Behaviour

To observe 'behaviour' best there should be no interference with the birds.

A **healthy chicken** is active, vital, alert, has a strong appearance; it has clear, active, bold and bright eyes which seem to come out; it has a proud posture, makes talking sounds, is active with eating, drinking and scraping in the litter and is sexually active (parent stock).

Abnormalities

- The chicken is inactive, sleepy, sits too much, is slow and dull. All diseases cause decreased activity, less attention for the surroundings, less appetite and often less water consumption. Very sick birds are bent (crooked), have closed eyes, feathers standing up and drooped wings and tail.
- The chicken is too active, afraid, nervous, frightened, restless.
- There are abnormal activities: pecking at own cloaca, cannibalism, itching, excessive pecking of own feathers, head shaking, nervous movements, respiratory problems.
- Heatstress: spread wings, open beaks, rapid respiration.
- Chickens are not very sensitive to pain; when they show pain there is something wrong.
- Abnormal appetite and eating abnormal things such as bedding.
- Changes in secondary sex characteristics (hen) and behaviour towards cocks; such hens are not productive.

re 2. Body temperature

Body temperature in chickens is not taken as a routine as in mammals. The normal cloaca temperature of an adult chicken is 41 °C. The temperature of an active adult chicken is quite strongly influenced by the environmental (ambient) temperature.

Taking the body temperature is mainly important to discover heat stress or cold stress in young chicks.

Increased body temperature due to a hot environment is called hyperthermia; when due to infection it is called fever.

re 3. The condition

The 'condition' of a chicken is the proportion between bones, meat and fat. It depends on genetic factors, feeding, egg production and whether or not the bird is healthy.

The best way to learn about the condition is to weigh the chicken; the weight can then be compared with the standard weight for breed, sex and age. Remarks:

- When the bird is lifted, the weight together with the natural tension of wing muscles are measured and noticed. Low weight and low tension indicate a weak bird. Healthy, active hens resist lifting.
- When chickens are in good condition, the breastbone (= sternum) is covered with muscles. Emaciated (= thin) birds have a sharp breastbone without observable muscles.

A 'rubbery' breastbone, often in combination with curving, indicates decalcification (loss of calcium).

In layers the breastbone position is declining from front to back, in non-layers horizontal.

- Fat birds are heavy, have a thick abdominal wall and increased abdominal contents (abdomen = belly).

Meat-type birds are long and wide, but not 'deep.'

Deep birds have a large intestinal volume and have little meat ('hollow' birds). Deep chickens are called 'balloon' chickens.

re 4. The skin and its appendages

The skin can best be observed on its head ornaments: comb, wattles and ears.

The skin is the 'mirror of health'. Depending on age, sex and breed, the comb and wattles are red, firm and shining and the skin itself is soft, fine, silky and loose and pliable on breast and abdomen.

The ears should be soft, round and dry. The ears are white in white egg layers and red in coloured egg layers.

The skin appendages are the feathers, the scales, the shaft bones, the beaks and the claws.

Skin abnormalities can be located at the surface or below.

To inspect the skin beneath the feathers, the feathers are blown open and kept open by the fingers.

Healthy birds have shining feathers (due to the action of fat glands).

Young layers have a complete, shining feather cover.

Abnormalities

- Feathers. In sick birds the feathers stand up beginning on the head. Feathers can be dirty, dusty, rough, worn, broken, loose, delayed, partly absent by moulting, abnormal in shape.

Good layers have worn feathers in the second half of the laying period, especially in the tail.

Small batteries cause worn feathers. Mating causes worn feathers on the back of the hens.

Hens which start moulting early are not the best layers.

- Skin pigment. In yellow-legged breeds and crosses the cloaca, eyelids, beaks and legs are yellow. In layers the colour disappears in the order cloaca, eyelids, beaks, legs and comes back in the same order when production stops.

- Comb and wattle abnormalities: shrunken, swollen, inflammation, necrosis, lesions, crusts, scabs, fungus ('powder comb'). The colour can turn pale, bluish or black.

- Skin: dehydration of the skin on the keelbone; skin wounds, small bleedings, bloodvessel tumours (leucosis = bloodcysts). Problems under the skin: oedema, bursitis on the keelbone, bleedings causing greenish discolouration, tumours in and under the skin, inflammation.

- Day-old chicks should not have an open navel or a bubble on the navel and their belly should not be hard and distended.

- The shanks should be straight, shining and have well-closed scales. Mange causes a thickened, greyish skin.

- The feet should not have long claws (staying in batteries) or footsole abnormalities.

re 5. Circulatory system, blood and lymph

The circulatory system includes the heart, blood vessels (arteries, veins, capillaries), blood, tissue fluid and lymph. The bonemarrow and lymphoid tissues produce the blood.

anaemia = blood and tissues have a pale colour due to lack of blood

oedema = accumulation of blood fluid; hot oedema (inflammation, painful) and cold oedema

waterbelly = accumulation of fluid in the belly (ascites)
dehydration = skin on the keelbone less flexible
haemorrhages = internal bleedings, light or heavy, becoming greenish by blood breakdown

A bluish discolouration indicates accumulation of CO₂ in the blood (cyanosis); a bluish-black colour of comb/wattle is a combination of cyanosis and other abnormalities.

re 6. Respiratory organs including eye mucous membrane

The normal respiration frequency is 35× per minute.

Conjunctivitis (inflammation of the mucous membrane joining eyelids and eyeball) accompanies most respiratory infections or may even be the beginning. A swollen nose mucous membrane prevents the drainage of tears through the tear duct.

Abnormalities

- Wet eyes, dirty eyes, tear streaks, red eyes, sunken eyes, blinking with the eyes because of pain, pus, necrotic material, haemorrhages, eyeworms, closed eye (often by sticky excretion), inflammation of the cornea, putrefied eye.
- Nose discharge (the normal nose is dry and clean): dirty, dark nostrils, watery, pus, bloodstained, crusts, closed nostrils, headshaking, dirty feathers on neck and wing because of nose cleaning, dirty smell of discharge.
- ‘Owlshead’ (swelling of cavities below eye socket), mainly by accumulation of cheesy pus material.
- Respiratory noises: weak sounds only to be heard during the night, coughing, sneezing, rattle in the throat, screaming, sawing sound.
- Open beak with stretched neck, gasping, pumping respiration, distress.
Gasping without respiratory noises indicates problems without the involvement of the upper air tract.

re 7. Digestive organs

Abnormalities

- * Beak: debeaking quality, crusts, necrosis, crossed beaks, loss of beak.
- * Tongue: curled, dark colour.
- * Mouth, throat, gullet: colour, inflammation, warts, crusts, pseudomembranes, nasal cleft clean or with exudate.
- * Crop: contents (preferably filled), paralysed, ruptured, suspended, gas, too hard, stoppage.
- * Increased size of belly: fat (thick wall), waterbelly, inflammation of membrane lining belly cavity (peritonitis), tumours, intestinal stoppage, laying difficulties, parasites.
- * Palpation of the belly is done with the thumb on one side and two or three fingers on the other side of the belly. Both thumb and fingers palpate; palpate with care! as follows:
 - *laying birds*: proper volume, thin and flexible wall, gizzard easily palpable, just behind the point of the breastbone;
between layingbones 4-5 cm (2 to 3 fingers) distance;
between layingbone and breastbone 8-10 cm (4 to 5 fingers);
the laying bones are loose, easy to move;
the cloaca is pink, moist, somewhat swollen, oval-shaped and relatively large
 - *non-laying birds*: belly less voluminous, somewhat drawn up, between layingbones about 2 cm (one finger) distance, between layingbone and breastbone 4-5 cm (2 to 3 fingers);
cloaca round, yellow, dry, relatively small
 - *fat birds*: heavy, belly wall thick and stiff, gizzard difficult to palpate

re 8. Uro-genital organs

- Cloaca: size variable, dry or moist, colour, wounds, cloaca sticking out (prolapsus), inflammation (cannibalism), dirty through diarrhoea or inflamed oviduct or broken egg inside.

A small, round, dry, retracted and yellow cloaca indicates non-laying.

Producing hens have a pink/flesh coloured cloaca that is moist, relatively large and oval shaped.

- Faeces are best to be checked under cages or slatted floors. Normally there are two kinds:
 - 1 solid, coarse structure, greyish-green, partly covered by a thin, whitish layer of uric acid salts (urates);
 - 2 pasty brown or a little foamy, wet brown droppings coming from the caeca and appearing a few times a day.

Abnormal is: too thin, watery, slimy, spinach colour (very green), pink mucus strings, fibrous flakes, red or black blood, bad smell, yellow, white, poorly digested, much fluid around normal faeces, frothy, parasites.

re 9. Locomotive organs

The locomotive organs consist of bones, joints, muscles, tendons and tendonsheaths.

Abnormalities

- Of bones: decalcification, crooked bones, (eg. keelbone, 'battery fatigue'), broken bones, torsion of shinbone (causing slipped tendon), bone thickening, broken back.
- Of joints: distorted joints, wings and legs; arthritis: swollen, asymmetry, warm, painful, red; deformed joints, abnormal kneejoint, joints too wide.
- Of muscles: atrophy, tumours.
- Of tendon: rupture, displacement, leg making rowing movements.
Of tendonsheath: synovitis = inflamed tendonsheath.
- Toes curled or crooked.
- The nervous system can also cause locomotion problems.

re 10. Nervous system and sense organs

Nervous symptoms are unsteadiness of legs, etc., e.g. cock-gait, trembling, lack of balance,

convulsions, twisted head, head backward, laying on the floor with cycling movements, hysteria, abnormal fright, beating with the wings, jumping.

Remarks

- 1 Paralysis can affect every system: respiratory muscles, digestive system, crop paralysis, intestinal stoppage.
- 2 Test for normal *wing movement*: hold the bird with the thighs and make a sudden, falling movement - both wings should react, in the same way.
Test for normal leg movement: hold the bird with the wings, let the bird fall (gently) on a table or floor - both legs should stretch and the toes should spread simultaneously.
Suddenly lifting the bird should result in symmetrical flexure of the legs.
Holding the bird with the legs up and the back down - both legs should move actively and in the same way.
- 3 *The eyes*: normal eyes are active, with a sharp lining between iris and pupil, the iris is in most breeds red/orange, the pupil is black and shining. Normal eyes follow the movement of objects and a bird reacts when a finger approaches the eyes.
The pupil becomes smaller when lighted by a torch (also spontaneous changes occur).
Iris abnormalities: too small, irregular, greyish, not reacting.
In a killed bird an abnormal iris often does not widen.
- 4 *The ear*: sometimes inflamed as a result of throat infection. Sometimes there are parasites in the ear canal e.g. fly larvae (myiasis).

(8.2 adapted from texts written by J.J.Dik and R.T.Haalstra)

A piece of *chicken sociology* to end this section:

As soon as two cocks or hens meet for the first time, they establish at once a relation of domination and subordination (the weaker one is afraid of the stronger).

This leads to the well-known *pecking order* in flocks of chickens: the tendency of weak birds to be driven away from feeding and watering places, to be poorly nourished, not to grow (and produce) well and to become still more the victim of the others.

Breeding cocks prevent one another from mating with the hens. The weaker cocks try to isolate themselves and gradually lose sexual activity, with their semen becoming very poor. This can be overcome by keeping the weakened cocks on their own for some time so that they regain their strength.

It is thought that in large flocks the birds form *sub-groups*; the members of one sub-group recognize each other and get along well but outsiders are rejected. This has practical consequences: there should be sufficient feeder troughs, waterers and laying nests well distributed over the house, so that the sub-groups can organize themselves around them and live there in peace and harmony.....

8.3 Cleaning & disinfection of chicken houses

Domestic animals which are kept in intensive systems, accumulate a lot of pathogens (= disease-causing organisms).

Thorough cleaning each time after the evacuation of a batch of chickens prevents the building up of a high contamination pressure. Especially day-old chicks are very sensitive. If the cleaning is poorly done we may expect pests and diseases to attack the new flock.

The reason for cleaning is to *save* money, to *earn* money and to *increase the reliability* and predictability of the production system. And cleaning is more important than disinfection!

Cleaning should start *as soon as possible* after the evacuation of the birds for two reasons:

- as we wait, the dirt dries and attaches itself more strongly to floors and equipment; so cleaning becomes more difficult
- when we clean immediately, the resting period becomes longer; during the resting period the remaining pathogens die, due to the disinfectant which has been applied, or through the drying process and the light (ventilation and light during the resting period are very helpful)

Take all the feed (and all the equipment) out of the house. Again for two reasons:

- during cleaning, the feed would be contaminated with water and dirt
- during the resting period the feed would attract moisture and dirt from the air; the feed would spoil from mould growth

When there are silos on the farm, they should be emptied and thoroughly cleaned.

Why should cleaning be done *thoroughly*:

- by cleaning thoroughly, we can remove 99% of all pathogens
- when we do it poorly, the usefulness of our work is low; there is little difference in usefulness between poor cleaning and not cleaning at all, hence poor cleaning is a waste of effort and water
- after cleaning comes disinfection; disinfection without perfect cleaning has generally little sense

The cleaning job

1 We start with soaking equipment and slats in a submerging tank. After each use the tank should be thoroughly cleaned. Soaking should last about 3 hours.

If a hose is used, the 'hosing' should be combined with 'brushing', otherwise too much water and effort is lost and the results are not satisfactory. Mind that people have a natural inclination to do hosing instead of brushing.

- 2 Feed remainders, manure and litter are removed from the house and transported to a place at a certain distance from the farm.
- 3 The upper parts of the house are cleaned by brushing. The floor is cleaned by scraping and sweeping. Do not forget the surroundings of the house!
Sometimes soap is used to clean equipment. Also a hot 2-5% Na₂CO₃ solution (soda) is an excellent cleaner.
'Clean' means: there is no more visible dirt on the surfaces (this may need inspection!).

High pressure equipment

- the pressure should constantly be 40-50 kg/cm²; a higher pressure can be destructive
- the optimum water use is about 12 litres per minute
- the round opening ('round-jet' is used for cleaning at a longer distance, e.g. the ceiling the chink-shaped opening ('flat-jet') is the best cleaner; it is kept at 10-30 cm from the dirty surface
- high pressure cleaning equipment producing hot water has no advantage above cleaning with cold water

Disinfection

Before disinfection, check for the presence of beetles, weevils, ectoparasites, etc. If insects are present apply insecticide after disinfection of the house.

Disinfection means taking the infection away; disinfection is *only possible after thorough cleaning*.

Disinfectants are normally applied with a knapsack sprayer.

The normal quantity of disinfectant solution is:

- 1 litre per 10 m² of ceiling
- 1 litre per 4 m² of porous wall
- 1 litre per 8 m² of smooth wall
- 1 litre per 2½ m² of floor

Never mix two disinfectants then after a thorough study (possibly inactivation, explosion, production of toxic gas).

- Disinfect all equipment, ceiling and walls down to a height of 1 metre from the floor, with calcium hypochlorite Ca(ClO)₂, 10 g/litre water. Make an estimation of the total surface area; use 1 litre disinfectant per 5 m² surface area (approx.).

Calculate the quantity of disinfectant solution to prepare. Disinfect by spraying with a knapsack sprayer. Let everything dry. Make sure that everywhere the disinfectant solution can drain away from the equipment.

The remains of the chlorine need not to be washed away (no rinsing required).

- Disinfect the floor and lower part of the walls by whitewashing (painting with brush), with a mixture of lime and water.

The lime should stay white during the whitewashing. If it becomes brown, then the surface is dirty and the cleaning should be done again.

- Apply insecticide if found necessary.
- Now the house is locked and nobody should enter.
Allow maximum light and ventilation during the resting period.
Control rodents and flies in the surroundings.

- The resting period is the best time to repair the house.

When cracks in the floor (cement) have to be repaired, this is done after thorough cleaning.

In this case the disinfection of the floor will be done afterwards.

Note: the disinfection of a chicken house with a beaten earth floor is almost impossible. Consequently such a chicken house can only last the time of a single batch of birds. It should be removed and rebuilt at every batch change.

The best products to be used are:

- 1 chlorine products
 - such as 60% $\text{Ca}(\text{ClO})_2$ as a 1% solution which is a cheap product
 - or organic chlorine products like chloramine and dichlor isocyanid acid which have a longer action but are more expensive
- 2 formaldehyde
 - generally as formalin (which is a 40% solution of the gas formaldehyde in water); it is used as a 3-10% solution
 - it is a very irritating gas and a mask should be used when it is sprayed with a knapsack sprayer
- 3 phenol derivatives such as carbolic acid (cresol) and lysol
 - they last long and also kill insects and mites
 - generally as a 3% solution
- 4 slaked lime $\text{Ca}(\text{OH})_2$
 - for whitewashing floors and walls (up to 1 metre height)
 - 200-400 grams quicklime CaO per litre of water; stir regularly during use
 - it is active by its high pH; it also controls insects and repels rodents
- 5 a mixture of lime and ammonium sulphate (both fertilizer quality)
 - excellent disinfectant of floor
 - 1 kg lime, 2 kg ammonium sulphate per 10 m² of floor surface, 10 litres water
 - first spread both powders evenly over the floor area and then pour water with a watering can; work rapidly and systematically, from one end to the other and use a mask (ammonia!)
- 6 U.V.light (sunshine)
 - the sun is a very cheap and important 'disinfectant' but works only superficially
 - U.V.light does not pass through glass
 - if possible, clean equipment outside, in the normal way, as prescribed; after cleaning use 'sunshine' as a disinfectant

On mud floors apply lime without water. Spread the lime evenly, ½ kg lime per m². The walls are whitewashed normally.

Disinfection in case of an outbreak of a serious infectious disease

In case of an NCD outbreak, the house should be disinfected before cleaning (and after cleaning too of course). Disinfection before cleaning is done to reduce the spread of the NCD virus.

Different disinfectants can be used to disinfect the bedding and the manure:

- 1 formalin
 - per 100 m², pour 300 litres 5%, with a watering can; use a mask
- 2 caustic soda NaOH , lye
 - it is very corrosive and caustic; in general it is used as a 2% solution
 - per 100 m², pour 300 litres NaOH 2%, with a watering can
- 3 quicklime CaO
 - a caustic product becoming hot with water
 - per 100 m², spread 70 kg CaO and pour 300 litres water, with a watering can

Let the disinfectant work for 2-3 days.

After disinfection, transport the manure carefully to a safe place, preferably a shallow hole.

Cover the manure with soil. After six months the manure is safe for use or transport.

8.4 Infectious diseases in chickens

In modern chicken farming, diseases should be seen in relation to the *flock as a whole*. Economically speaking it makes no sense to treat the individual bird.

On the other hand the health of individual birds is certainly something that influences the economic result of a chicken enterprise. With margins usually being low, a light increase in mortality in a batch of laying hens (normally less than 1% per month) may reduce profitability to nil.

Even worse is a drop in egg production of a few percents or a rise in the feed conversion rate (more feed for less eggs).

Normally, chickens which are *well fed and managed* and have been *vaccinated* against known local diseases, remain healthy.

DISEASE PREVENTION should then receive most attention.

But if there is a disease outbreak, sick birds should be separated from the healthy ones and strict sanitary measures should be applied to all the chicken houses. And a veterinarian or extension worker should be notified immediately.

As far as Western Europe is concerned, the occurrence and importance of the different chicken diseases vary with time. In the course of time the measures that were taken to control diseases have rendered certain diseases less prominent whilst other diseases have become more important.

For instance, in the past, parasites in the intestines caused heavy losses. In the fifties, diseases of the respiratory organs were important. In the sixties Marek's disease and leucosis caused great problems. Lately new diseases have appeared, such as Gumboro.

Infectious chicken *diseases spread* in various ways:

- 1 infection from animal to animal ('horizontal infection')
- 2 infection from the environment, men and all sorts of materials
- 3 infection by way of the hatching egg ('vertical infection')

Chicken diseases may be divided into groups, as follows:

- 1 infectious respiratory diseases
- 2 neoplastic diseases
- 3 avian adenoviral diseases
- 4 miscellaneous virus diseases
- 5 miscellaneous bacterial diseases
- 6 diseases caused by parasites
- 7 non-contagious diseases

On the following pages is a (very) brief description of some of the above diseases.

One source of information was the brochure 'Important poultry diseases' published by INTERVET International, Boxmeer, Holland.

8.4.1 Infectious respiratory diseases

Chronic Respiratory Disease (CRD) or Airsacculitis

This condition is frequently triggered by respiratory viruses such as the viruses causing Newcastle Disease (ND) and Infectious Bronchitis (IB) and then complicated by bacterial invasion.

The main bacteria found in the infection are *Mycoplasma gallisepticum* (Mg) and *E. coli*.

Stress caused by moving the birds, overcrowding, poor ventilation, dust, draughts, debeaking or other operations, makes the birds more susceptible. Infected birds spread the disease by contact or by breathing.

Parent birds infected with Mg can transmit the organisms through the egg to their offspring.

clinical signs

Young chickens (broiler chicks or layer pullets) show respiratory distress. Often there is lack of appetite resulting in decreased weight gain and increased feed conversion rate (more feed per weight gain).

In adult chickens the most common symptoms are sneezing, coughing and general signs of respiratory congestion.

In laying birds egg production drops.

Normally CRD does not cause an alarming number of deaths. But the overall economic loss can be (very) great.

treatment and control

Control and eradication of MG infection is by far the most effective method of combating CRD. Fertile eggs from infected birds can be treated with antibiotics to eliminate the Mg organisms (injection of fertile eggs or egg dipping).

Blood serum testing of breeder chickens for Mg antibodies has become routine.

Infectious Coryza

The cause is a bacterium called *Hemophilus paragallinarum*. The disease spreads from bird to bird and flock to flock by contact and airborne infected dust particles and via the drinking water. Equipment and personnel can also spread the disease. The incubation period varies from 1 to 3 days.

clinical signs

The main signs of the disease are inflammation of eyes and nose, with foulsmelling discharges, conjunctivitis, sneezing and facial swellings. Feed and water intake is reduced (weight losses, drop in egg production). Mortality varies but is generally low.

The symptoms are similar to CRD.

treatment and control

Eradication and prevention are the most desirable means of controlling coryza. Vaccines have been developed but are only used in areas where the disease is endemic and cannot be eradicated.

Aspergillosis (or Fungal pneumonia)

The disease is caused by a fungus named *Aspergillus fumigatus*. Transmission is by inhalation of fungus spores from contaminated feed. Hatcheries may also contribute to infection of chicks. Young chicks are very susceptible; older chicks are more resistant to infection.

clinical signs

Infected chicks are depressed and thirsty. Gasping and rapid breathing ('pump handle breathing') can be observed. Mortality varies from 5 to 50%. The lungs and airsacs are affected in the first place. Yellowish-white pinpoint lesions can be found. Sometimes all body cavities are filled with small, yellowish-green granular fungus growth.

treatment and control

There is no treatment for aspergillosis. Affected chicks should be removed and destroyed. Strict hygiene in breeding and hatchery management is necessary. Choice of litter material is important so that no spore-bearing wood shavings are used.

Newcastle Disease (ND or NCD)

ND is a very serious virus disease that may attack many different kinds of birds (not just poultry) and occurs world-wide. It is a highly contagious disease and spreads through infected droppings and respiratory discharge between birds.

Spread between farms is by infected equipment, trucks, personnel, wild birds or simply the air.

The incubation period varies but is usually from 3 to 6 days.

clinical signs

ND causes high mortality, with depression and death in 3 to 5 days as major signs.

Difficult breathing, with wheezing and gurgling, accompanied by nervous signs (such as paralysis or twisted necks) are the main indications. Egg production decreases 30 to 50% or more. Eggs may have thin shells or have no shells at all.

control

There is no treatment for ND. The only thing to do is *vaccination* as a preventive measure. In Holland the vaccination for ND is obligatory.

Infectious Bronchitis (IB)

IB is a virus disease. IB is very infectious and is transmitted from bird to bird by the airborne route. It can also spread by air between chicken houses and even from farm to farm. It only affects chickens (and not other kinds of birds).

clinical signs

In young chicks the infection causes a cheesy exudate in the bifurcation of the bronchi. This chokes the chick to death, preceded by severe respiratory distress ('pump handle breathing'). In older chicks IB is not lethal.

Respiratory signs include wet rale, gurgling and wheezing.

Egg production will decrease dramatically, sometimes to zero, and will never return to normal levels; often there will be deformed eggs with wrinkled shells.

treatment and control

There is no treatment for IB. Secondary infections may be prevented by, or treated with antibiotics. Prevention by *vaccination* is the best method to control IB.

Infectious Laryngotracheitis (ILT)

ILT is caused by a virus. Infection is from bird to bird by the respiratory route. Most outbreaks of ILT on farms are due to transmission by visitors, shoes, clothing, egg boxes, used feeders, drinkers, cages, crates, etc.

The incubation period varies from 4 to 12 days.

clinical signs

Sometimes breathing becomes extremely difficult ('pump handle breathing') and the birds die from suffocation. Mortality is approximately 1% per day in a typical ILT outbreak. Milder forms of ILT outbreaks occur where less virulent strains of ILT virus are involved. Conjunctivitis and respiratory sounds (wheezing) may then be observed, with little or no mortality.

The disease spreads through a chicken house more slowly than either IB or ND.

Egg production in laying flocks will usually decrease 10 to 50% but will return to normal after 3 to 4 weeks.

treatment and control

Prevention of ILT by vaccination with mild eyedrop vaccine is by far the best control method. Sometimes such vaccines are applied by drinking water or spray methods, with variable success.

Even after an outbreak of ILT has been detected in a chicken flock, immediate vaccination is advisable to stop the spread of infection.

Avian Influenza

Avian influenza is caused by a virus. Airborne virus particles from the respiratory tract, droppings and people carrying virus on their clothing and equipment are the main routes of transmission. Avian influenza also affects turkeys and ducks. In 2003 there was a very serious outbreak in Holland; see addendum.

8.4.2 Neoplastic diseases

Lymphoid Leucosis (LL)

Other names: big liver disease, visceral leucosis.

Lymphoid leucosis is a virus disease transmitted by horizontal and vertical infection. Leucosis leads to tumorous growths which especially affect the liver and spleen.

An infection with the leucosis virus during the first six weeks of the life of a young chicken has an incubation period of at least 100 days after which the bird becomes ill. Chickens that are infected after this age are able to build up resistance and overcome the infection.

Leucosis is a lingering disease. The birds become sluggish, with combs turning pale and shrivelling; production stops and the birds become thinner and thinner and eventually die.

LL may be confused with Marek's disease, but in LL the nervous system is never involved (no paralysis).

Up to date it has not been possible to effectively control leucosis. The parent stock would have to be made leucosis-free after which the young would have to be reared under very strict hygienic conditions.

Marek's Disease (MD) or Neurolymphomatosis

The virus is mainly transmitted through infected premises.

The day-old chicks become infected by the oral respiratory route. Susceptibility decreases after the first few days of age. The infection is followed by an incubation period after which the birds may show typical disease symptoms.

Hereditary disposition, general health and external conditions (stress) partly determine whether or not the disease symptoms appear. The virus spreads horizontally, from bird to bird.

Infected birds lose weight or may show some form of paralysis. The classical form (paralysis) with leg nerve involvement causes a bird to lie on its side with one leg stretched forward and the other backward.

The presence of *tumours* in liver, spleen, kidneys, lungs, ovary, muscles or other tissues indicates MD, but may also point to LL. However, nerve involvement is typical of MD.

Especially older birds may be affected by blindness. Skin involvement often consists of tumours of feather follicles or between follicles (skin leucosis).

As with other chicken diseases, *preventive* care is very important:

- strict hygiene, especially rearing in isolation
- the breeding of Marek-resistant strains
- but especially *vaccination* of day-old chicks; the Marek reagent is administered by injection and gives lifelong protection.

However, MD vaccine only prevents the appearance of the tumours and paralysis of Marek's disease, it does *not* prevent the birds from becoming infected with MD virus.

8.4.3 Avian adenoviral diseases

Inclusion Body Hepatitis - Infectious Anaemia

The above two diseases are caused by an avian adenovirus and occur simultaneously. Egg transmission is an important factor but horizontal transmission also takes place from bird to bird by contact with droppings.

clinical signs

The two diseases strike usually at 5 to 7 weeks. The birds are listless, have ruffled feathers and appear very pale. Mortality is usually quite severe, up to 25% in the first ten days of the disease.

treatment and control

There is no treatment. The best method of control is to ensure adequate immunity against Infectious Bursal Disease (Gumboro) in breeder chickens.

Egg Drop Syndrome 1976 (EDS '76)

The virus of this disease is transmitted through the egg to a few birds in a flock; these birds carry the virus until the flock comes into lay at which time they begin to excrete virus and infect birds kept in the same house.

clinical signs

EDS '76 affects only layers and breeders at the start of or during their egg production period.

Affected birds fail to reach peak egg production, or egg production drops and is accompanied by an inferior egg shell quality and loss of shell colour (in the case of brown eggs).

Affected birds may also appear to be anaemic, may show a passing diarrhoea and sometimes the food intake may be reduced.

There is no mortality. IB (and to a lesser extent ND and ILT) will also have to be considered.

treatment and control

There is no treatment for EDS '76. Vaccination is the only available effective control method.

8.4.4 Miscellaneous virus diseases

Fowl Pox (avian pox or avian diphtheria)

Fowl pox is a virus disease. The introduction of infected or 'carrier' birds into a susceptible flock will cause an outbreak by direct contact and by water and feed transmission. Biting insects such as most mosquitoes can also transmit the virus from bird to bird in the flock and to nearby flocks.

The incubation period varies from 4 to 20 days.

clinical signs

- wart-like lesions on the head, combs and wattles, yellow to dark brown in colour
- internal lesions ('wet pox') in the mouth, gullet and/or windpipe, yellowwhite and cheesy in appearance

Affected birds are depressed, lack appetite and breathe laboriously when 'wet pox' is present. Mortality varies from low to over 40% ('wet pox').

It is difficult to treat affected birds. Preventive vaccination using a live vaccine is by far the most successful control method.

Even when an outbreak of fowl pox has been diagnosed, it is advisable to vaccinate the flock immediately, to stop further spread of the infection.

Avian Encephalomyelitis (AE) or epidemic tremor

The AE virus is mainly transmitted through eggs (vertical transmission). Infected breeders will transmit the AE virus for several weeks and egg hatchability will decline.

Infected chicks that hatch will show signs of the disease and spread the infection in the incubator to other newly-hatched susceptible chicks. Young chicks can also be infected on the farm.

The incubation period varies from 5 to 14 days depending on the route of infection.

AE is mainly a disease of young chicks, between 1 and 3 weeks of age. Affected chicks sit on their hocks, do not move well, and many fall on their sides. A fine, rapid tremor of the head and neck can be seen, but especially *felt* when affected chicks are held in the hand.

In laying and breeding flocks, AE virus infection causes a marked drop in egg production which returns to normal in about 2 weeks. Mortality in chicks can be high.

Preventive *vaccination* of breeder pullets with live AE vaccine before egg production starts is the only effective means of AE control.

If a breeder flock has not been, or has been improperly, vaccinated and an outbreak occurs, it is advisable to stop the hatching of eggs from the flock for several weeks until the breeders have acquired immunity and no longer transmit AE virus.

Infectious Bursal Disease (IBD) or Gumboro disease

IBD is caused by a very stable virus which is difficult to eradicate from an infected farm. IBD virus is very infectious and spreads easily from bird to bird by way of droppings. Infected clothing and equipment are means of transmission between farms. Especially young birds may be affected.

Affected birds are listless and depressed, pale and huddling and some may die.

Of more economic importance is the subclinical form in which the immune system of the bird is affected leading to Gumboro disease-related diseases such as Infectious Anaemia.

In broilers this form of the disease results in poor performance.

In *acute* cases the bursa is enlarged and gelatinous, sometimes even bloody. In chronic cases the bursa is smaller than normal. The lack of white blood cells (lymphocytes) results in decreased resistance of the birds to other infections.

There is *no treatment*. The vaccination of parent breeders and/or young chicks is the best means of control.

Viral Arthritis/Tenosynovitis (VA)

The virus may be transmitted by droppings from bird to bird. Egg transmission is also a factor when breeder flocks become infected during egg production. Not all strains of the virus are pathogenic.

clinical signs

The first signs of VA/tenosynovitis are usually observed in broiler breeder chickens between 6 and 10 weeks of age. The birds are reluctant to walk and, when forced, have a painful and trembling gait.

A distinct swelling of the tendons of the shanks and above the hock joint can be observed.

Leg problems in broilers or broiler breeders associated with swelling of shank tendons or tendons above the hock joint, sometimes accompanied by ruptured tendons, are indicative of VA/tenosynovitis.

treatment and control

VA/tenosynovitis cannot be treated successfully.

Malabsorption Syndrome

This complex disease has been reported under various names such as helicopter disease, femoral head necrosis, brittle bone disease, infectious proventriculus, pale bird syndrome, runting disease and stunting disease.

The disease is mainly observed in broiler flocks. Many affected broiler flocks have a history of diarrhoea, beginning as early as a few days of age and lasting until 10 to 14 days of age. Light or dark brown, foamy droppings can be found with undigested food particles.

Several affected broilers in a flock may show malpositioned feathers, especially on the wings.

Early rickets with extreme paleness of legs and heads can be observed. At a later age (5-6 weeks) osteoporosis becomes evident, often causing the birds to limp. Later, an important effect is the delayed growth of the affected birds.

Mortality varies.

treatment and control

Treatment is impossible and no specific vaccines against this disease are yet available.

Strict hygiene and sanitation will reduce the incidence of this disease.

8.4.5 Miscellaneous bacterial diseases

Infectious Synovitis

This disease is caused by *Mycoplasma synoviae* (Ms).

Vertical transmission from Ms-infected breeder hens is most common. But horizontal transmission from bird to bird and transmission by infected equipment, clothing, shoes and egg boxes, also occur.

The symptoms vary from mild respiratory signs to synovitis (= inflammatory swelling of the joints of legs and wings) and inflammation of the sternal bursa ('breast blisters').

Creamy exudate (to exude = ooze out, give off moisture etc. like sweat) in joints extending into tendon tissues is indicative.

Staphylococcus arthritis (a bacterium) can also cause swollen joints with a creamy exudate sometimes extending into the tendon sheaths. Viral arthritis can also cause swelling of joints and tendon sheaths, but the exudate is more watery or blood-tinged unless secondary *Staphylococcus* infection occurs.

Ms infections can be treated with antibiotics with greater or lesser success. But blood testing of breeder chickens and the elimination of positive Ms reactors is a much better way of controlling infectious synovitis.

Fowl Cholera or pasteurellosis

Fowl cholera is caused by a bacterium named *Pasteurella multocida*.

Transmission of fowl cholera is mainly from bird to bird, by water or food contamination. Rats and mice also appear to play a role in the contamination of water and feed with *Pasteurella multocida*.

Affected birds are depressed and have less appetite. Egg production drops and mortality is high in *acute* fowl cholera. Birds that die from acute fowl cholera often have bluish combs and wattles.

Chronic fowl cholera does not cause high mortality; swollen wattles is a feature of chronic fowl cholera.

Internally, there is haemorrhage and congestion of liver, spleen and kidneys. In chronic fowl cholera, cheesy exudate can be found between the intestines and on the liver and heart.

Treatment with the proper antibiotics or medicines can be successful in stopping mortality and restoring egg production. If clinical fowl cholera, with mortality, reappears, one must treat again.

Rodent control is also very important to prevent the infection from appearing again.

Vaccines are available.

Pullorum Disease and Fowl Typhoid

Other name: Bacillary White Diarrhoea (BWD).

Pullorum disease (briefly called 'pullorum') is a *disease of the young chicken* and is caused by a bacterium, *Salmonella pullorum*.

The symptoms of pullorum are lack of appetite, heads tucked in and wings hanging down, slimy greyish-white diarrhoea with pasted vents, sometimes respiratory problems, crowding, peeping sounds and high mortality.

Older animals may be carriers of the disease without showing the symptoms.

The bacteria spread horizontally from bird to bird (via droppings) and vertically, through the eggs of infected breeder hens.

Fowl typhoid is caused by *Salmonella gallinarum* which is related to, but not identical with *S. pullorum*.

Fowl typhoid is more a disease of adult chickens, with high mortality. Transmission through infected droppings, bird carcasses and infected clothing, shoes and utensils, is important in fowl typhoid.

Fowl typhoid in adult chickens causes listlessness and sulphur-coloured diarrhoea. The birds have a generalized infection with swollen livers, spleens and kidneys and bleeding in these organs.

Blood testing of breeder chickens and subsequent elimination of 'carrier' birds will stop the incidence of egg-transmitted pullorum.

If hatching eggs from tested pullorum-free breeders are kept free from contamination by infected eggs from infected breeders, or from contaminated incubators, or other contaminated equipment, chickens can remain pullorum-free.

Treatment of pullorum will not bring about a cure. The same applies to fowl typhoid.

The remedy is therefore to start with healthy day-old chicks from breeders who submit their birds to regular blood testing, and then to keep the chicks pullorum-free.

DISEASES CAUSED BY PARASITES : see Chapter 9

8.4.6 Non-contagious diseases

Ill health may have other causes than those referred to above.

We mention here the diseases which are related to *nutrition*.

When certain essential components are lacking in the diet of chickens, diseases with characteristic symptoms will develop:

- vitamin *E* deficiency = crazy chick disease, encephalomalacia
 - affects the brain, causing degeneration, oedema and haemorrhage
 - affected young birds appear unable to walk, they fall on their sides or stand with their heads between their legs
 - may also be found in adult chickens
- vitamin *B* deficiency = curly toe disease
 - young chicks, as early as one-week old, show curling of toes, inability to walk and sometimes diarrhoea
- vitamin *D* deficiency = rickets, 'rubber legs'
 - young chickens, 2 to 5 weeks of age, with vitamin D deficiency, are unable to stand and have very soft, pliable legs and beaks ('rubber')
 - the rib joints are swollen like beads and curved inward; the breast bone is often twisted
 - in older chickens, vitamin D deficiency causes soft-shelled eggs and a drop in production
 - an incorrect calcium/phosphorus balance in the feed also leads to rickets

Young, growing animals especially are affected by vitamin deficiencies in the feed.

The daily provision of sufficient amounts of *green fodder* is one insurance against vitamin deficiency diseases.

Poisonous substances may cause ill health and even widespread death in serious cases.

It is not always possible to pinpoint the cause. Sometimes it is clear that:

- 1 poisonous pesticides
- 2 excessive amounts of minerals (for instance)
- 3 poisons formed by moulds

have contaminated the feed one way or another.

Addendum page 116, on Avian influenza

In the year 2003 **Avian influenza** struck the poultry industry in Holland. It is an industry with at any time some 100 million chickens (in recent years).

There was an outbreak in March and, despite the measures which were taken to prevent the spreading of the disease ('stamping-out', including farms surrounding infected farms), a few months later many farms were affected. In the summer of 2003 the country was declared disease-free again. In the meantime, one third to one quarter of the chicken population had to be killed (by the application of CO₂ gas, heavier than air) and destroyed.

The Government compensated the farmers for the chickens which had to be destroyed, but not for the losses the farmers incurred because of 'empty houses' following the destruction.

Flocks could become affected suddenly, from one day to another, and farmers were very apprehensive when entering their chicken houses. Infected chickens rapidly had severe respiratory problems and mortality was very high.

(editor)

8.5 Diagnosing poultry diseases

Many poultry diseases may exist in a *chronic* state, e.g. coccidiosis and CRD. Those in daily charge of poultry flocks may not be aware of a problem but nevertheless production is then not what it should be and this may even threaten the profitability of the farm.

With poultry it is not the individual bird that counts but the *group*. It is important *to observe the flock as a whole* (group diagnosis):

- development of disease
- number of birds affected
- symptoms: sounds of sneezing, signs of diarrhoea on the litter, position of sick animals in the group

Note: see section 8.2 'flock observation and health control'

Laboratory examinations too are carried out on a *number of birds*, not just on an individual, in order to be valid.

The discovery in the laboratory of some germ considered harmful under certain conditions is not a proper diagnosis, since diseases appear more and more in the form of (world-wide) *syndromes*, i.e. one harmful micro-organism associated with another causing a disorder.

For instance, the association between Salmonella and chronic coccidial infections in syndromes resulting in diarrhoea.

Diagnosing poultry diseases in a *laboratory* is by no means easy. It requires poultry disease specialists with a lot of laboratory experience coupled with observations made on many different farms.

In the *tropics* diagnostic difficulties are often increased by the isolated position of laboratories, if they exist at all.

In addition, the samples sent to the laboratories may not have been well prepared and preserved and properly transported.

8.6 Immunity and vaccination

Taking proper care of farm animals is the most important thing to do in order to prevent diseases.

It will strengthen the *resistance* of the animals to diseases in general. Important signs of good resistance are proper condition (animal looks good and is lively), healthy mucous membranes and proper functioning of the stomach.

‘Resistance’ protects the animal from **all** diseases and (temporarily) unfavourable environmental conditions.

Immunity protects the animal from **one** specific disease. For that reason (a high level of) resistance is more important than immunity.

However, resistance and immunity cannot be separated from each other. A normal or even high level of resistance is needed to build up immunity. In general, proper animal care enhances both resistance and immunity.

8.6.1 Immunity

When an animal has suffered (and recovered from) an infection, it has built up a *specific* protection against this infection, for a longer or shorter period.

This specific protection is called *immunity*.

The immunity is produced by lymphocytes which are present in lymphfollicles in the animal body.

Where do we find most lymphocytes in the chicken body:

- in all mucosae of the chicken body
- in two special ‘youth glands’: the thymus and the bursa; the thymus is scattered in the neck along trachea and oesophagus, the bursa is situated above the cloaca
- in two special glands, one behind the eye of the chicken and the other in the spleen near the stomach (chickens have no lymph glands like mammals have)

To get proper immunity, it is desirable to bring the pathogens (disease-causing organisms) in close contact with the lymph follicles. Immunity is produced in those lymphfollicles that come into contact with the pathogens.

Vaccination is ‘artificial’ infection resulting in immunity.

Generally speaking the immunity is at its best when we imitate the natural infection. For instance:

- the vaccine is applied there where the natural infection enters the body
- virulent pathogens give the best immunity; ‘virulent’ means rapid multiplication of the pathogens in the body, often in the mucous membranes

Immunity is made up of four elements:

Circulating antibodies

Antibodies are proteins produced by lymphocytes and circulating in the blood. Antibodies are transmitted to the newborn animals; in birds via the yolk in the egg. So a young chick has the highest concentration (= titre) of antibodies in the blood at the age of four days, when the yolk is nearly absorbed.

The immunity of the newborn animal derived from the mother is called *maternal immunity*. Maternal immunity only consists of one type of antibody and has about the same titre as that of the mother.

There are 5 types of antibodies, each with a specific half-lifetime and specific functions against pathogens and toxins.

Circulating anticells

Anticells are lymphocytes which can kill infected or abnormal cells.

Local antibodies and anticells in the mucous membranes

These antibodies and anticells are not circulating in the blood but are produced and located in the mucous membranes. They give **local** immunity. Local immunity is the most effective protection because it prevents the entrance of pathogens.

Memory cells in the lymphfollicles

After an infection (or vaccination) a certain number of lymphocytes keeps 'remembering' the production of antibodies and anticells. If there is renewed contact with the same pathogen, the production of antibodies and anticells starts much earlier than before and happens on a much larger scale, thanks to the presence of these 'memory' cells.

For this reason many kinds of vaccinations have to be repeated:

- the first one (the 'primer') results in low-level immunity but produces memory cells
- each repeated vaccination utilizes the memory cells which are present, and this results in a more rapid, stronger and longerlasting immunity (so-called booster vaccinations)

In the case of mammals, sometimes *antibodies* are injected, in order to obtain *rapid* protection. The antibodies may have come from blood serum or may have been produced in a laboratory.

Here we speak of *passive* immunity (maternal immunity too is 'passive'). In *active* immunity the animal itself makes the antibodies/anticells, during a natural infection (whether noticed or not) or after a vaccination.

Normally, active immunity lasts much longer than passive immunity.

Antigens play a role in many processes

An *antigen* is any substance in the body which may lead to the making of antibodies and anticells:

- therefore pathogens and vaccines may be called antigens
- sometimes animals make abnormally large quantities of antibodies or anticells against abnormal products: we then speak of allergy or hypersensitivity
- the proteins of each animal are specific and act as antigen in another animal

Immunity is a process with a *beginning and an end*.

After a vaccination antibodies and anticells appear after 5-7 days and reach a peak in 2-3 weeks (in general). This is the period of maximum antibody titre.

Then follows decline which is rapid at first.

The duration of the presence of antibodies and immunity is specific for each disease.

The general state of health of the animal (care!) plays an important role: poor animal care results in low-level immunity that also disappears more rapidly.

8.6.2 Chicken vaccines

Chicken vaccines are mainly applied in three different ways:

- 1 local vaccination on the mucosae (= mucous membranes)
- 2 injection of vaccine underneath the skin
- 3 vaccination in the skin itself

Local vaccination is used for *live* vaccines.

Examples are eyedrop, spray and oral vaccination.

Advantages of local vaccination are:

- a (nearly) immediate local protection by virus vaccine
- less risk (compared with injection) that circulating antibodies neutralize the vaccine
- all four elements of immunity become involved

Oral vaccinations are only successful if the virus can survive the acidity level of the stomach of the chicken (chloric acid HCl; pH=2!).

Injection is mainly subcutaneous (S.C., underneath the skin) and intramuscular (I.M.). It is the only way to administer dead vaccines.

Strongly irritating vaccines are given intramuscularly.

Examples of *vaccination in the skin*:

- follicle application, against fowl pox
- wing-web method is used for pathogenic strains of NCD

Important *differences* between live and dead virus vaccines:

Table 29:

Live vaccine	Dead vaccine
rapid protection, hence indicated in case of high risks	protection develops more slowly
more natural, resulting in more complete protection (antibodies + anticells)	protection mainly based on circulating antibodies
cheap, because most of the virus is produced in the vaccinated bird	expensive, because quite a lot of virus is needed for one dose
combinations are difficult	combinations are possible; so-called cocktails
cell destruction, hence reactions are possible	less health risks
risk of spread of virus	no spread
risk of inactivation during storage	easier to store
suitable for mass treatment	often needs 'priming'; can give homogeneous and high-level titres which is important for parentstock (protection of chicks)

The **composition** of a vaccine:

- 1 The (weakened) disease organism or/and its products (toxins).
- 2 Rest of the medium in which the disease organism was grown.
- 3 Added substances to stabilize (mainly) live vaccines.
- 4 Anti-microbial products in dead vaccines.
- 5 Added substances to stimulate immunity-build up, the so-called adjuvants, (mainly) in dead vaccines.
- 6 Added substances to get a 'slow release', the so-called oil vaccines; this improves antibody production.

Producing a vaccine is a highly complex process, with many technologies involved (company secrets!). This is one of the reasons why the quality of vaccines varies considerably.

Live virus vaccines are generally freeze-dried, and sometimes vacuum-packed in ampoules.

Important types of vaccines and antigens are:

Virus vaccines

Mainly virus grown in embryonating eggs or in tissue culture.

- 1 Naturally occurring viruses:
 - fully virulent virus given at a safe age; example AE
 - weak virus strains; example NCD Lasota, Hitchner, a.o.
 - related viruses of another animal species; HVT (Herpes virus of turkeys) against Marek
- 2 Artificially weakened ('attenuated'); IB.
- 3 Dead virus vaccines, e.g. oil vaccines against NCD, IB, Gumboro, EDS.

Nowadays laboratories are actively trying to develop virus vaccines which consist only of parts of pathogens, so-called immune stimulating complexes (Iscoms).

Bacterial vaccines

Bacterial vaccines can easily be cultivated in artificial media.

- 1 Live non-virulent bacteria.
- 2 Dead bacteria, generally together with their toxic products; e.g. Pasteurella, Coryza.
- 3 Inactivated bacterial toxins, e.g. Clostridial vaccines.

Antigens for rapid plate agglutination

These antigens are used for diagnostic purposes, e.g. to demonstrate the presence of antibodies. Important antigens for plate diagnosis are:

- Salmonella pullorum antigen
- Mycoplasma gallisepticum antigen.

8.6.3 Buying and storing vaccines

Recommendations with regard to the purchase and storage of vaccines for chickens:

- 1 Buy vaccines from a reliable, specialized firm or veterinarian selling relatively large quantities of vaccines
 - check type of vaccine, dose, date of expiry
 - check the sealing; vaccine becomes rapidly inactivated in damaged bottles and ampoules which have lost their vacuum.
- 2 When buying a vaccine, bring an ice-box along and take the vaccine home as rapidly as possible.
- 3 It is essential to have a reliable refrigerator
 - large farms need two refrigerators and a stand-by electricity generator in case of power failure
 - place the refrigerator in a cool, dry and well-ventilated room
 - maintain the refrigerator properly and check ice formation regularly.
- 4 The temperature inside the refrigerator should be as stable as possible, between 2 and 6 °C
 - the refrigerator should have a thermometer or maximum-minimum thermometer inside; check the temperature regularly
 - open the refrigerator door as seldom as possible - the door should be locked
 - if possible use the refrigerator only for the storage of products which have to be kept inside for a long time
 - never put hot products or large quantities of warm products in the refrigerator
 - put the vaccine as deeply as possible inside, to reduce temperature fluctuations
 - do not take the vaccine out if this is not necessary; temperature fluctuations are harmful for live vaccines
 - do not put vaccines in the freezing compartment.

8.6.4 Drinking water vaccination

Vaccination with drinking water is often considered easy but in reality it is not. The main difficulties are:

- the unequal distribution of the vaccine water over the birds
- it is difficult to keep the drinking water cool
- the vaccine may be inactivated in the acid stomach of the chickens
- vaccine virus may stick to dirty or rough surfaces of the equipment
- the inactivation of vaccine virus because of
 - traces of drugs, detergents or disinfectants
 - rusting equipment, metal drinkers
 - poor drinking water quality (chlorine, heavy metals! have the water tested beforehand)

- easy neutralization of several vaccine viruses by antibodies, either maternal or actively produced.

Generally speaking the results of drinking water vaccination are variable and often poor, especially for respiratory viruses such as NCD and IB. But if well performed, good results can be obtained for intestinal viruses such as IBD and AE.

Vaccination with **pipéd water** or with medicine tanks:

- the results are even more unreliable than with handwatering
- the pipes, etc., must be clean and free of algae
- in low pressure and in nipple systems the vaccine water is put in (small) reservoirs
- when the house is very long it is nearly impossible to get the vaccine rapidly to places which are far away
- it is difficult to get reservoirs and pipes clean and free of chemicals
- adding skim milkpowder can later result in blocked nipples; whole milkproducts cannot be used because the fats would contaminate the system
- water nipples with meters can cause additional problems
- in high pressure water systems the vaccine water must be put into the drinkers (troughs)
- medicine tanks are not suitable for vaccination purposes

How drinking water vaccination should be carried out

Materials which are needed:

vaccine, cleaning materials, plastic watering can(s), skim milkpowder, measuring equipment, a mixing vessel, stirrer, a pail with disinfectant, packing materials.

All the equipment should be very clean and absolutely free of disinfectants and detergents by rinsing several times with clean water.

Sequence of activities; as follows.

- 1 Read the instructions accompanying the vaccine and check the type of vaccine, the number of doses and the date of expiry.
- 2 A few days before the vaccination day extra plastic drinkers are added, so that all birds can drink at the same time and the birds get accustomed to use them. The last few days before vaccination no drugs, disinfectants or detergents should be used.
- 3 Only good quality, cool water should be used
 - free of heavy metals, chlorine, less than 50 mg NO₃/litre, no NO₂
 - good quality public tap water without chlorine can be used; rainwater can also be used
 - boiling the water is a good practice; the water should be rapidly cooled down afterwards
 It is safe and preferable to add milkprotein for the protection of the vaccine virus:
 - most common is to use 2 g skim milkpowder per litre of water
 - it is also possible to use 20 ml pasteurized or sterilized skim milk or whole milk or 20 ml of boiled fresh milk/litre of water
 - milk replacers for young animals or baby feeding should not be used because of possible harmful additives in these products (for the vaccine virus)
 - using more milk than the above-mentioned minimum quantities is all-right up to a maximum of 50% milk or 50 g skim milkpowder per litre of water
- 4 The best time for vaccination is at a cool period of the day; this is the (early) morning. It is then easier to get cool drinking water and to keep it cool.
- 5 At the time of vaccination all the birds should be a little bit thirsty
 - supply no water for at least two hours prior to vaccination; laying birds and young chicks for not longer than two hours, rearing birds sometimes longer, up to twelve hours
 - the aim is to get a *rapid* water consumption, by *all* birds
 - because of irregular water consumption of chicks, this method is not advised before the age of three weeks

- 6 The drinkers are cleaned thoroughly with brush and clean water just before vaccination. The drinkers should not be exposed to sunlight (in order to keep the temperature down).
- 7 Calculate the quantity of water that is needed:
 - the water should be consumed within 2-3 hours
 - the number of chickens
 - consider age, type of bird, environmental temperature and humidity
 - a general rule is to use as many litres of water /1000 birds as the age of the birds in days, with a maximum of 40 litres; e.g. 4 days old = 4 litres, 47 days old = 40 litres per 1000 birds
- 8 Measure and prepare the drinking water and measure the milkproduct:
 - mix 2 g of skim milk powder with one litre of water
 - to protect the vaccine virus, the milk powder has to be added before the vaccine
- 9 For the distribution of the water, plastic watering cans are better than plastic pails:
 - the content in litres should be known
 - they should be perfectly clean
- 10 Mix the virus vaccine properly with the water, just before giving the water to the birds:
 - open the ampoule or flask
 - always spread the vaccine over the water (and not the other way round); quickly mix the vaccine by stirring
 - the best thing to do is to mix first with a small quantity of cool water, in a smoothly-walled calibrated vessel and then to put (or to distribute) this mixture in a measured amount of water in the watering can(s) whilst stirring well
- 11 Immediately after mixing, the vaccine is distributed to the chickens
 - work rapidly
 - start the distribution of the vaccine water at different places in the house
 - not all the vaccine water is given at the same time but keep the drinkers filled until all the vaccine water has been distributed
 - give no additional drinking water before all the vaccine water is finished
- 12 The cleaning-up phase:
 - pack and burn disposable objects or sterilize by boiling or disinfection
 - disinfect and then clean all equipment (and the hands)
- 13 Records:
 - date of vaccination
 - name of product, brand, batch number
 - number of doses
 - number of birds vaccinated

8.6.5 Eyedrop vaccination

Eyedrop vaccination is also called ocular vaccination.

How it works:

When vaccine is dropped on the eye, it comes in close contact with the mucous membrane of the eye. Part of the vaccine travels from the eye through the tear duct to the nose and there contacts the nose mucous membrane

- when there is inflammation (infection, irritation by dust or ammonia gas) the tear duct may be closed
- for several reasons good results of eyedrop vaccination can only be obtained with healthy birds, under good husbandry conditions.

Part of the vaccine in the nose is inhaled and enters into the windpipe and the bronchi, where it contacts the mucous membrane in these places.

In all these mucous membranes the virus of the vaccine multiplies which is essential for good immunity results.

The multiplied virus is then transported to the lymphfollicles of all mucous membranes.

The result of a good vaccination is the establishment of antibody immunity, anticell immunity and local mucous membrane immunity.

Indications for eyedrop vaccination:

- eyedrop is an excellent vaccination for NCD, is the best vaccination for IB and is the only practical vaccination for ILT;
- the birds have to be individually handled; this takes time but is paid for by the good results which are mainly due to the equal treatment of each individual bird

Vaccine can also be applied *directly to the nose* (nose drop, beak dipping). As these vaccination methods have no advantages as compared with eyedrop and have some disadvantages (less hygienic), they should not be recommended for chickens.

How eyedrop vaccination should be carried out

Materials which are needed:

vaccine, catching rack for chickens, measuring device for liquids (20 ml syringe or measuring glass) and a bucket with a disinfectant

Sequence of activities:

- 1 Read the directions for use accompanying the vaccine and check the type of vaccine, the number of doses and the date of expiry.
Plan the vaccination for the cool period of the day; this is good for the vaccine and causes less stress to the chickens.
- 2 Calculate the amount of vaccine diluent that is needed:
 - one drop of water is about 0.04 ml, so for each 100 drops 4 ml of water is needed. But the drop size of the virus solution depends on the vaccine components and on the size of pipette that is used. Hence, follow the directions of the vaccine producer and your own experience in this matter. In general, taking into account a margin for small losses, we need 5 ml (cc) of diluent per 100 birds or 50 ml per 1000 birds
 - as diluent can be used:
 - special diluents (normal saline), often supplied in special soft plastic pipette flasks, are to be preferred
 - distilled water, de-mineralized water, rainwater and chlorine-free tap water can also be used; the latter two should be boiled and then rapidly cooled down
 - store the diluent in the refrigerator, at 4-8E
- 3 Check whether everything is ready in the chicken house:
 - concentrate the birds on a small area
 - the separation between the vaccinated and the not yet vaccinated birds should be very strict when the vaccination is carried out
- 4 Prepare the vaccine solution:
 - up to the moment of preparation, vaccine and diluent should stay in the refrigerator
 - in general, all the vaccine virus of a flask or ampoule should be used in the preparation of the required amount of vaccine solution. Extra vaccine virus in the solution is seldom a problem; too little vaccine virus is always wrong
 - the amount of diluent is measured with a syringe or a measuring glass
 - with the help of a syringe or pipette an amount of diluent is injected into the vaccine flask (or ampoule) filling about 3/4 of the flask
 - shake well and pour the vaccine virus into the diluent; shake again and the vaccine is now ready for use

- in the case of virus in ampoules, it may be more convenient to spread the dry virus vaccine over the surface of the diluent
 - preferably only prepare one flask/ampoule of the vaccine at a time
- 5 Carry out the vaccination:
- start vaccinating the birds immediately
 - one person presents and passes the chickens one by one
 - with the pipette, one drop of solution is dropped on one of the eyeballs whilst the eye is fully open. Choose either the left or the right eye but in all birds the same eye. The choice depends on the vaccinator being either right- or lefthanded, and on the way the other person presents the chicken. If one eye looks abnormal (because of pecking or dust), then the normal eye is chosen
 - the head of the bird is held in sidewise position. The best approach is to spread upper and lower eyelid with thumb and finger, to expose a part of the mucous membrane or to lift the (lower) eyelid a little in order to prepare a 'sac' that takes more vaccine. This also prevents closing of the eye; in that case the vaccine drops on the eyelid (repeat the vaccination)
 - during vaccination and between two vaccinations, the pipette flask or pipette is kept in a vertical position
 - holding the pipette flask not vertically, the drop size changes or the vaccine can run spontaneously out of the pipette
 - do not hold the vaccine flask in the full hand because this would warm the vaccine too much
- 6 The cleaning phase
- pack and burn disposable objects or sterilize by boiling
 - first disinfect and then clean all articles used (also the hands)
- 7 Records
- date, name of product, brand, batch number, number of doses
 - number of birds vaccinated

8.7 Treating chicken diseases

It should be realized that *treating sick birds generally means that prevention and hygiene have failed*. When we have to treat sick birds we are usually too late, we are 'running behind the problem' instead of in front.

Problems in the treatment of chickens

- 1 Intestinal absorption of a drug. Using a drug that is not absorbed (= does not pass from the intestines into the body) only makes sense when the infection is localized in the intestines
 - poor or no intestinal absorption: aminoglycosides (amikacin, gentamycin, kanamycin, streptomycin, tobramycin, neomycin, spectinomycin), polymyxin (polymyxin B, colistine), bacitracine, virginiamycine, flavomycin, furoxone, framycetin
 - good or reasonable absorption: synthetic or semi-synthetic penicillines, tetracyclines, spiramycin, oleandomycin, erythromycin, tylosin, lincomycin, chloramphenicol
- 2 Destruction in the stomach, mainly by hydrochloric acid: penicillin, chlortetracycline, erythromycin.
- 3 Inactivation or reaction with other nutrients, e.g. tetracyclines react with calcium which prevents absorption.
- 4 The taste can decrease water or feedconsumption: sulfa-dimidine - Na, chloramphenicol, tylosine. They can cause a severe drop in egg production.
- 5 Sick animals eat less and may drink less. Great individual variations inside the flock exists. Healthy and highly productive birds eat and drink much.
- 6 The dose must be based on the live weight. Therefore the concentration has to be based on feed or water consumption.

- 7 As feed or water are consumed gradually it can take a long time before a curative level in the blood is reached.
- 8 Flock treatment generally results in growth depression by lower feed consumption or toxicities. Because of the variation in intake, intoxicators in small numbers of birds are common (e.g. sulfas, furoxone).
- 9 The normal intestinal flora is often suppressed or changed:
 - Neomycin, tylosin and lincomycin suppress the anaerobic intestinal flora predisposing for Salmonella infection, Salmonella activation and longer excretion period.
 - Lincomycine: same effect as neomycin.
- 10 Birds may be too sick or too weak to reach drinking or eating places e.g. E. necatrix infection.
- 11 Supplying the exact dose is very difficult. Even under ideal conditions the variation in blood-level of the drugs will be very great.
- 12 Treating sick birds in a flock is expensive because all birds are treated. In the choice of a drug costs and advantages have to be weighed. Sometimes a cheaper and less active drug is preferred above an expensive excellent drug.
- 13 Individual treatment is the best treatment and can be done by injection, pills or capsules. But it has also disadvantages because birds have to be caught and handled. This causes stress especially in layers resulting in egg drop. It may be necessary eg. in E. necatrix infection because sick birds do no longer eat and drink. Injections are given with a thin, sharp needle, subcutaneously (neck) or intramuscularly (breast muscle, leg muscles)
 - oral application deep into the gullet by syringe and blunt needle is possible
 Normally about 90% of the plateau-level is reached in four times the half-lifetime of drugs.
 Stopping: four times half-lifetime results in 10% of the plateau-level, seven times half-lifetime results in < 1% of the plateau-level.
- 14 Accumulation. Drugs may accumulate e.g. tetracyclines in the bones.
- 15 Contamination of the environment with drugs may happen.
- 16 Antibiotic treatment can cause yeast and fungus infections e.g. monilia.
- 17 Treatment with drugs which are absorbed always results in residues in eggs and also in meat when the withdrawal period is not respected.
- 18 The relation between the concentrations in feed and water depends on the respective consumption. In feed the concentration should be 2 to ? times higher than in water.
- 19 The way of application influences the price of drugs:
 - injectable drugs are expensive because they have to be pure, sterile and non-irritating
 - soluble drugs also are relatively pure and expensive
 - in feed non-soluble drugs can be used; they can be less pure and are the cheapest drugs.

General instructions

- Sick birds have to be separated from the healthy birds. Because in the flock sick birds would be driven away from feed and water and for that reason treatment results would be poor.
- Intensive treatment: to reduce the infection pressure it is essential to treat sick birds intensively. This can only be realized by separating the sick birds.
- Selection: to reduce infection pressure, sick birds with little hope for recovery are killed before the treatment starts. This selection continues during and after the treatment.
- Hygiene during treatment is important. After treatment it is useful or essential to remove the litter and do cleaning to prevent reinfection.
- Antibigram: for drugs which are regularly used a regular testing of the sensitivity is important.

Treatment by the feed

- 1 Advantages
 - easy to distribute and for this reason preferred by the owner
 - non-soluble, cheap products can be used
- 2 Disadvantages
 - it takes time to prepare the medicated feed in the feedmill

- mixing and de-mixing can create problems. In complicated factories with many pipes and machines, a large part of the drug can get lost and contaminate other feeds
- the high temperature during pelleting can destroy drugs
- the high temperature in the silo can destroy drugs
- reaction and inactivation by feed components is possible
- sick animals eat less, healthy and highly productive animals eat more

3 Instructions

- the feed must be produced separately, transported separately, stocked separately and (the bags) must be well labelled
- for mixing, first a premix is made (ration or special carrier). Then this larger quantity is mixed with the remainder
- do not try to mix drugs with prepared pellets or crumbles
- sprinkling a premix with drugs over the feed troughs is a very unreliable method and is contraindicated with toxic drugs
- in case of feed restriction the concentration of the drug has to be adapted
- when the drugs are given through feed soaked with water, the supernatant water will be rich in soluble drugs and can cause intoxications

Treatment by drinking water

1 Advantages

- can be started immediately and can be followed by medicated feed that takes time to prepare
- sick birds continue to drink after they have stopped eating

2 Disadvantages

- the water consumption between flocks can vary considerably
- the water consumption inside the flock can be greatly different
 - birds with diarrhoea may drink very much
 - birds which eat little, drink little
 - temperature differences in the house influence water consumption
- only soluble drugs can be used
- suspensions can sink to the bottom and cause serious intoxications, which can happen with the poorly soluble nitrofurans
- the quality of the water is important
 - pH is often too low. Ideal is 7 or a little higher
- the stability of many products in water is low

3 Instructions

- dissolving and preparing the right concentration need precise instructions
- the pH can be corrected by NaOH
 - sulfadruugs, best is pH > 8
 - tylosine, best is pH 5.5 to 7
- with high water consumption in the tropics the concentration has to be adapted
- for drugs which are difficult to dissolve the following measures can be of help:
 - first mix the drug with some milkpowder
 - or add a little bit of liquid detergent for washing domestic dishes
- with automatic watering equipment the following things are necessary:
 - a special drug tank is needed
 - the tank is placed high in the house
 - the tank must be closed against dust and dirt
 - the tank must have a good device for reading the amount of water the tank contains
 - a stopcock must prevent the flow of drugs into the wrong water pipe
 - after use, the tank and the pipes must be cleaned thoroughly
 - automatic dosers which can be connected with the water pipes are available but seldom work with enough precision

- bitter drugs can be corrected by sweets. Sugar of sugarsyrup 2 to 5 ml/litre water. First dissolve in warm water
- fresh solutions have to be made at least once daily
- the drinkers have to be clean otherwise much drug can get lost
- the best treatment is to dissolve the drugs first in a small quantity of water. In some cases the water has to be added to the drug and not the contrary) e.g. tylosine.

Combining drugs

- interference with absorption is possible
- interference with excretion is possible
- potentiation of activities. Potentiation is that the activity of the combination is more than the addition of both (synergism):
 - sulfas with 2-4 diaminopyrimidines: pyrethrine, pyrimethamine, diaverdine, entrimethoprim
 - chloramphenicol + polymyxine
 - penicillines + streptomycin
- antagonism
 - do not combine bacteriostatic with bactericidal drugs
 - bacteriostatic are tetracycline, spiramycine, erythromycin, tylosine, lincomycin, chloramphenicol, sulfas
 - bactericidal are penicillines, bacitracin, streptomycin, framycetin, kanamycin, neomycin
- generally a too low concentration of each drug is used
- a big risk for decreased colonisation resistance
- using more types of drugs increases the risk of resistance

Toxic combinations:

- tiamutin + monensin: nervous symptoms, low egg production, unfertile eggs
- tiamutin + lasalocid (Avatec)
- nitrofuranes + zoalene

Toxicity of drugs

- young birds are more susceptible because of lower activity of kidneys and liver
- see individual drugs and combinations

1 Drugs toxic for all chickens

- furoxone; growth depression even at 100 ppm in young birds
- see individual drugs

2 Drugs toxic for all layers

- coxyl (sulfaquinoxaline - Na 5% pyrimethamine 1.5%)
- cycostat (robenidine 6.6%)
- ethopabate
- furoxone can cause lower egg production
- maxulvet (sulfadimethoxin 33.5%)
- nicrasin (nicarazine 25%), nicarbazine: eggdrop 50% or more, pale eggshell, small and deformed eggs, weak shells, mottled yolks
- pancoxin (amprolium 20%, ethopabate 1%, sulfaquinoxaline 12%)
- sulfa-drugs: sulfadimidine, sulfaquinoxaline, etc. poor quality shells, lower egg production, pale shells
- sulfa-Na (sulfaquinoxaline-Na 3% + pyrimethamine 0.9%)
- whitsyn S (sulfaquinazoline 30 mg/ml, pyrimethamine 9.1 mg/ml)

3 Drugs toxic for parent stock and breeding stock

- see also layers
- anti-coccidials: pyrimethamines (daraprim): embryonal death, hatching percentage up to zero
- furoxone: lower hatching percentage

Resistance to antibiotics

Occurrence:

- is mainly a problem in Gram-negative bacteria: *E. coli*, *Salmonella*
- resistant strains can be introduced by one-day old chicks through the hatchery. So resistance is possible in farms where no drugs have been used
- routine preventive treatments increase resistance
- low concentrations (often in preventive treatments) increase resistance
- some drugs easily create resistance: streptomycin
- some drugs create multi-resistance. Multi-resistance is the combined resistance to different groups of drugs (e.g. neomycin)
- in a healthy environment, where no antibiotics/chemotherapeutics are used, the resistance disappears rather rapidly.

Residues in poultry products

Eggs:

- drugs absorbed into the blood can be present during 10 days in the yolk, but in the albumen for a short time only

Meat:

- for meat we should respect the instructions of the withdrawal period

Treatment with antibiotics

1 Preventive treatments during a few days

Indications:

- transport stress
- debeaking/toe amputation
- virus infections
- vaccination with live vaccines

Disadvantages:

- they are not directed against a specific causative organism
- generally too low doses are used
- increase bacterial resistance
- often cause of growth depression
- destroy or interfere with the normal bacterial flora
- costs are generally much higher than the advantages

2 Curative treatments

- only treat when a proper diagnosis has been made.

Common drugs in poultry

1 *Chloramphenicol*

- drinking water 1-2 g/ltr (lower concentration give no therapeutic bloodlevel); feed 4 g/kg
- rapid absorption, half-life time 80 minutes (in man 4 hours)
- layers: results in residues in the eggs
- chloramphenicol is rather insoluble (1:400); the palmitate form is to be used, is quite soluble and less bitter
- toxicity: is toxic for the bloodcell producing tissues (bone marrow)

2 *Flumequine* (Flumic contains 3% flumequine)

- 12 mg/kg bodyweight 20 g/50 kg b.w. Gives a good therapeutic bloodlevel
- good absorption, half-life time 1 hour; good therapeutic blood levels
- indications: E. coli, Salmonella, Pasteurella
- resistance: difficult to develop and is of the more-steps type;
 - no cross-resistance with tetracycline, chloramphenicol, neomycin, sulfas, trimethoprim, furazolidone
- no growth depression

3 *Neomycin*

- oral application is not to be advised:
 - no absorption
 - easily creating multi-resistance
 - decreasing colonisation-resistance to Salmonella, increased period of Salmonella excretion
- do not combine with synthetic amino-acid cystin/cystein

4 *Nitrofuranes*

- no (or a very low) absorption, no therapeutic blood levels, no use for systematic diseases
- furoxone } in feed 100-200 ppm
- nitrofurantoïne }
- in water - 2 ml of a 3% suspension per ltr
- the absorption is influenced by the particle size (crystal size)
- nitrofuranes can be toxic for ducks, turkeys, guinea fowls and quails

All waterbirds receive the half dose.
 In all birds they decrease leucocyte production.
 Can lower the hatching percentage.

Furoxone

- growth depression
- the absorption is generally very low
- not soluble in water

Nitrofurantoïne (furadantine)

- the absorption is better than furoxone but the renal excretion is so rapid that no measurable blood level exists
- the taste is bitter

5 *Penicillines*

- only synthetic products can be used orally, the biological products are destroyed in the stomach by HCl

Ampicilline

- drinking water 1.1 g/ltr (lower dose gives no therapeutic blood level) e.g. against E. coli; for intestinal action 55 mg/ltr water
- rapid absorption; half-life time 15 minutes (in man 5 hours)

6 *Sulfa drugs*

- sulfadimidine - Na: 2 g/ltr water 3-2-2 (5 days with an interruption of 3 days); good therapeutic blood levels against E. coli
- Es B 3 (can be used in layers)
 - 30% mixture: 1 g/ltr water; good therapeutic blood levels e.g. against E. coli
- toxicity: kidney damage, haemorrhages, blood in faeces; in layers decreased production, eggs with thin shells or no shells

7 *Tetracyclines:*

- chlortetracycline (aereomycin)
- oxytetracycline (terramycin)
- tetracycline

Drinking water 1 g/ltr gives a therapeutic bloodlevel, e.g. against *E. coli*; for intestinal action 0.2 g/ltr water.

Rapid absorption. Tetracycline gives the highest blood-level

- the watertroughs and tubes have to be clean. Tetracyclines adhere to proteins giving loss of drugs and formation of sediment
- quite soluble with exception of chlortetracycline
- they are not stable in watery solutions
- they form insoluble complexes with calcium and magnesium, reducing strongly the activity. The same happens with hard water producing a brown sediment plugging the drinking nipples. They accumulate in the bones.

9 Diseases caused by parasites

9.1 Coccidiosis

Coccidiosis is the most common contagious disease in chicken farming. It is caused by several coccidium species which generally affect the intestinal tract of the chickens.

The symptoms vary from acute death mainly in young birds, to suboptimal production in all ages (that is to say, production is not what it should be).

Coccidiosis is caused by coccidia (singular coccidium) which are protozoa, one-celled parasites.

Where there are chickens there are coccidia!

Economic losses can be enormous. Large-scale chicken farming only became possible after the discovery of coccidial drugs.

Wire floors (or slatted) were mainly introduced to prevent coccidiosis.

Coccidiosis is the main single reason for suboptimal production. Already slight infection of the small intestine in broilers reduces their growth. The preventive use of anti-coccidiosis drugs in broilers and rearing stock represents quite a lot of money.

Coccidiosis is not only a disease of chickens, it occurs in all types of poultry. And, for instance, it can also affect goats kept under intensive husbandry in goat houses.

However, chickens have their own specific coccidia types which do not cross-infect other (bird) species.

In the chicken are *nine* species of coccidia, of which five are important. They are:

- | | |
|---------------------------|---|
| 1 Eimeria (E.) acervulina | very common, often subclinical |
| 2 E.maxima | mainly subclinical |
| 3 E.necatrix | together with tenella the most pathogenic species |
| 4 E.tenella | very common and pathogenic |
| 5 E.brunetti | |

The coccidium life-cycle is complicated and not exactly the same for the five species. There are three stages in the cycle. The first stage is an enormous, non-sexual multiplication *inside* the host. After that there is formation and fertilization of so-called *oocysts*, also inside the host. The oocysts are expelled with the faeces.

Under favourable conditions the oocysts then *sporulate* (they form so-called sporozoites) and become infective for chickens. Only sporulated oocysts cause infection.

The period of the cycle inside the host lasts 4-5 days (minimum) and the sporulation time under favourable conditions is 1-2 days. The total of the cycle is therefore 5-7 days, under favourable conditions.

Sporulation time depends on the factors (a) temperature, (b) humidity and (c) oxygen availability:

temperature

The optimum temperature is about 28 °C and about 90% of the oocysts will then sporulate in 1-2 days (if moisture conditions are right).

Each coccidium species has its own range of temperature for oocyst development, e.g. E.tenella = 12 to 33 °C.

Temperatures lower than the minimum temperature conserve the oocysts and there is no development.

moisture

Too dry means 'no development'. Good litter contains 17-35% moisture. Ideal conditions for the development of immunity in the chickens is litter with 30-35% moisture.

When it is too dry for sporulation the oocysts slowly die.

oxygen

There is seldom a lack of oxygen and 10% of air oxygen pressure is already sufficient for sporulation.

Oocysts are difficult to kill. Their resistance is high, especially in a humid and cool environment.

In litter oocysts are affected by dryness, high temperatures, ammonia, lack of oxygen and bacterial toxins.

Disinfectants in general have little influence, but ammonia kills in high concentration (5-10%); a combination of lime + ammonium sulphate (fertilizer quality) is effective in this respect.

Infection

Direct contact cannot infect the birds.

The chickens ingest the sporulated oocysts by eating and drinking. The infection is carried by contaminated buildings, the farm yard, litter, dust, contaminated feed and water, objects and persons. Also insects can transmit oocysts.

Introducing new chickens always means introducing coccidia.

infection pressure

The 'infection pressure' of coccidia depends on several factors, indicated as follows:

- whether the birds are kept on litter or on wire (slatted) floors
- stocking density
- hygiene in general
- moisture content of the litter which in itself is related to water spillage, ventilation and air humidity
- during dry, cool conditions unsporulated oocysts can accumulate; by a change to warm, humid weather or by diarrhoea, water leakage and lack of ventilation, these accumulated oocysts sporulate and can cause an acute outbreak of coccidiosis
- the environmental temperature; an increase in humidity and temperature often precedes an outbreak
- the number of sporulated oocysts ingested by the birds; *one* oocyst can already start the infection of a flock, later on resulting in a disease outbreak; in bacterial infections one bacterium can do nothing and in most bacterial infections 1,000 to 1,000,000 bacteria are needed to cause infection.

The 'pressure' also depends on the species: acute disease results after infection with 500,000 sporulated oocysts of *E.acervulina* but with only 10,000 oocysts of *E.tenella*.

Within the coccidia species there are differences in pathogenicity.

Mixed infections are common but generally one species strongly predominates.

Infections are often farm-linked; *coccidiosis is a management disease!*

The disease process

Acute outbreaks with rapid deaths are possible. In that case a large number of sporulated oocysts have been taken up (ingested) by the flock, in a short time.

The coccidia cause damage to the tissue forming the outer layer (= epithelium) of mucous membrane in the wall of the intestines of the chickens. The damage is mainly mechanical although there is production of toxins.

Tenella and necatrix cause haemorrhages, inflammation and epithelial loss; tenella in the caeca, necatrix in the small intestine (middle third part).

Maxima and brunetti cause epithelial loss and sometimes small haemorrhages; maxima in small intestine, brunetti in colon, cloaca, last part of small intestine and first part of caeca. Acervulina cause epithelial destruction without haemorrhages.

The pathological effects are:

- loss of resistance
- loss of many mucosa cells resulting in poor digestion
- loss of blood serum or blood to the intestinal content (6 anaemia)
- inflammation of intestinal wall
- production of toxins
- secondary infections and absorption of toxins by loss of epithelial cells

The result is that even subclinical infections already have a *distinctive negative effect* on appetite, condition, production, feed conversion and health.

In more severe cases the result is sick animals, rough feathers, diarrhoea by enteritis and mortality.

Immunity and resistance

Immunity is important and is more present in older birds. Because of the establishment of immunity, coccidiosis is mainly a problem in young chickens.

The immunity to coccidiosis is so-called species-specific; this means that a chicken can suffer from coccidiosis as often as five times (because there are five E. species).

The development of immunity depends on several factors:

- breed and age of the chickens
- the overall resistance of the flock
- the species of coccidium; the immunogenic property of the species decreases in the following order: maxima > brunetti > acervulina > tenella > necatrix;
as illustration: a mild infection of maxima gives good immunity but necatrix requires several re-infections to obtain good immunity
- drugs can interfere with the development of immunity depending on where and how the drug acts in the life-cycle of the coccidium

Older birds without immunity are more susceptible than young birds. Outbreaks of coccidiosis in broilers of a certain age cause more growth depression than in young birds.

Immunity can stop the cycle of development of a coccidium; with strong immunity there is no development at all.

Other infections e.g. Gumboro, worms, management errors, stress, etc., lower the overall resistance of the birds and often initiate an outbreak of coccidiosis.

Oocyst excretion

Oocyst excretion in a flock often lasts only a few weeks because of the development of immunity.

Large differences in oocyst production exist between species; it decreases in the following order: acervulina > tenella > brunetti > maxima > necatrix.

In an acute outbreak of disease, especially of necatrix and tenella, severe symptoms can precede the production of oocysts.

9.1.1 A brief discussion of the five Eimeria species affecting chickens

Eimeria acervulina: chronic, subclinical, low mortality

Affects first half of small intestine.

The cycle is completely performed in the epithelial cells; here oocysts can often be seen with the naked eye.

Lesions are caused mainly by the huge number of oocysts of which more than one can develop in the same cell.

Relapses are no exception because of the enormous contamination of the environment with oocysts, and the weak immunity.

Symptoms: in all ages, but often in older broilers and young layers. Many infections are subclinical or chronic (name: chronic coccidiosis).

In severe cases there is poor feed conversion, suboptimal growth and production, slightly increased mortality, pale and thin birds.

Organ damage: thickening of the wall of first part of small intestine, flaky turbid content, never haemorrhages.

In severe cases white striations (= linear marks) can be seen which are accumulations of oocysts and other stages, in the intestinal wall. In mild cases red mucous membranes.

Eimeria maxima: mainly chronic, subclinical, mortality low or moderate

Affects whole small intestine but especially middle third part. The lesions are mainly caused by stages other than oocysts. The oocyst production is low. There is a big loss of epithelial cells.

The spread in the flock is slow because of the low oocyst production.

A slight infection already gives a good, long-lasting immunity.

Symptoms: often in young birds around ten weeks of age, varying from subclinical to severe disease.

Severe: dull, diarrhoea often mucoid, some mortality.

Slight infections cause suboptimal condition and production, less growth and poor feed conversion.

Organ damage: in slight infections a red mucosa, enteritis.

Severe: intestine widened, swollen intestinal wall, brownish mucoid content, some haemorrhages in the wall are possible, never haemorrhagic content.

Many coccidiostats are not very active against *E. maxima*.

Eimeria necatrix: often acute, mortality can be high

Affects middle third part of small intestine but sometimes up to the gizzard. Many haemorrhages and severe inflammation.

The formation of oocysts takes place in the caeca without clear symptoms because oocyst production is low.

Necatrix is the most pathogenic form of coccidiosis in the small intestine. Immunity is difficult to build up, but after clinical infection there is a reasonable immunity.

Symptoms: generally the symptoms are clear and vary from acute to subacute, with birds affected up to 100% and acute mortality up to 30%.

Mainly in birds older than ten weeks, sometimes in broilers. *Necatrix* was a big problem in broilers before the discovery of coccidiostats.

The birds are dull, have a low appetite, depressed growth and egg production, bluish-red comb and wattles, watery or mucoid faeces sometimes with blood. Generally in a flock only some birds are clearly sick.

In severe cases the intestinal movement stops completely with the result that the bird neither eats nor drinks (no intake of drugs!). Afterwards the birds are very weak, with low resistance.

Organ damage: especially middle part of small intestine is widened, with a thick wall, many small or large haemorrhages, small white spots, content thin and mucoid often with blood.

In severe cases the intestinal wall is fragile and the content bloody; red mucosa with severe haemorrhages.

Necatrix is the most difficult form of coccidiosis to diagnose microscopically.

Eimeria tenella: often acute, mortality can be very high

Affects the caeca, seldom small intestine and colon.

Severe inflammation and large haemorrhages. Chicks can die by bleeding in the caeca.

The oocyst production is very high which causes acute outbreaks.
The destruction of the caeca is very serious.
Subclinical infections can give a reasonable immunity.

Symptoms: this is the most pathogenic form of coccidiosis.

Because oocyst production is very high and sporulation very rapid (24 hrs.), the disease occurs at a young age and spreads very rapidly. Many birds in a flock can be affected and mortality can be high. Often young chicks from 2 up to 10 weeks are affected but older birds including layers can also become sick.

Birds can die very quickly, in large numbers. Being very sick they stop eating, generally continue to drink, have drooped wings, pale-yellowish combs and wattles (because of severe anaemia).

Often acute haemorrhagic diarrhoea; sometimes the faeces is pure blood (it is the only chicken disease in which faeces is pure blood).

The birds huddle together forming groups because they feel cold.

The recovery after treatment is generally complete.

Sometimes the clot of fibrin in a caecum does not gradually disappear, causing chronic inflammation of the caecum.

Organ damage: large caeca, often haemorrhagic.

In light cases there is some blood in the caeca.

In severe cases the caeca are filled with blood. The blood forms a large clot which later gets a greyish colour and is gradually expelled in one or two weeks.

The carcass is very pale.

Eimeria brunetti: often acute, moderate mortality

Affects the colon, cloaca, last part of small intestine and beginning of caeca. Some small haemorrhages, but mainly severe loss of epithelium (necrosis).

After infection a good immunity develops.

Symptoms: rarely in young birds, but then more severe; sick birds with watery diarrhoea, sometimes with some blood.

In older pullets and young layers the symptoms are often less clear, sub-acute to subclinical, with a slightly increased mortality.

Organ damage: swollen intestinal wall, with red striations, small haemorrhages and necrotic enteritis or necrotic areas.

In severe cases the mucosa is a necrotic membrane.

9.1.2 Diagnosis of coccidiosis

The symptoms of coccidiosis are never specific, with the exception of blood diarrhoea in *E. tenella* outbreaks.

The examination of the faeces or the litter for coccidia oocysts gives very limited information. Post mortem examination is most important.

Severe infections can often be diagnosed by naked eye already, including the species concerned.

Microscopic examination is done in all routine post mortem examinations:

- At four places: border duodenal loop/small intestine; middle small intestine; border small intestine/caeca; caeca.
- Carefully push away the intestinal content with a knife without damaging the epithelium, because the intestinal content complicates the microscopic examination by presenting feed particles which may look like the parasite.
- Make a deep scraping of these four places, with an (object) slide glass or a knife and prepare four slides (use cover slips).
- Examine the four smears by magnification 10×10 .

Oocysts are seen as well defined, thick-walled, roundish to oval bodies with a granulated content surrounded by a clear area. This clear area is small or absent in very young oocysts.

Size about 2-3 mm under the microscope.

In case of doubt use magnification 10×40 .

- In practical situations typing of the species is never necessary. Typing in a specialized laboratory is a very expensive, time-consuming operation.

Routine examinations (so-called indicator method); as follows.

This is mainly practised in broilers at week 3 and week 5-6.

In farms without problems during the last two batches, the first examination can be done at 4 weeks.

For infected farms 4 weeks is too late because acervulina can have disappeared already.

In farms with severe problems, the examination has to be done every week starting during the second week.

Select 3-5 weak birds and examine the intestines at the four places mentioned above. Because coccidiosis is very contagious a few birds already give a reliable picture of the flock if these birds are taken from sites all over the house.

Examine (say) 20 fields at magnification 10×10 and count the number of oocysts per field.

Average number of oocysts per field:

Table 30:

	acervulina	maxima
not present	0	0
slight infection	50	5
moderate infection	50-250	5-50
heavy infection	> 250	> 50

N.B.: If no oocysts are found there may still be losses through coccidiosis because the examination may not have been done at the right time.

9.1.3 Therapy (treatment)

Besides drugs, *husbandry plays an important role*, as in any other chicken disease situation.

- The best results are obtained at the peak of the infection or shortly thereafter, so within one week after the start of the infection. Later on a treatment has little or no result.
The treatment costs of subclinical coccidiosis are about 10% of the losses caused by subclinical coccidiosis.
- In a flock two or more treatments may be necessary because of outbreaks of different coccidia species.
- The best result may be expected from a drug that acts strongly on that stage of the cycle which mainly causes the symptoms.
- Drugs in water act better than drugs in feed, because sick birds stop eating but generally continue drinking.
However, only a few drugs are soluble in water e.g. sulfadimidine, Na-sulfaquinoxaline, Na-sulfachlorpyrazine, Na-amprolium, Coxyl.
- Ideally all litter (bedding) and manure should be completely removed after treatment but this is in practice seldom possible.
However, at least dirty, wet spots in the litter should be removed, and drinking and feeding should be done under strictly hygienic conditions.
- The litter should be kept dry and loose in order to prevent sporulation.

9.1.4 Prevention of coccidiosis

The *prevention* of coccidiosis is based on three things:

- 1 hygiene
- 2 management
- 3 drugs

Vaccination does not play an important role so far and genetics (selection) is not very promising.

re 1. *hygiene*

- All-in all-out chicken farming, combined with thorough cleaning including dust removal and disinfection, immediately after the removal of the birds.
- Prevent the introduction of oocysts by persons, materials, animals or dust.
- Prevent contact with faeces. Wire floors or slatted floors prevent outbreaks even without the use of preventive drugs.
However, in young birds infection with acervulina is possible. And wire floors do not suit all types of chickens. In young birds of heavy breeds (parentstock of broilers) wire floors can cause many problems: synovitis, breast blisters, tibia torsion and slipped tendon.
- Have wire (slatted) floors around drinkers.
- Hygiene in watering and feeding. Prevent water leakage.

re 2. *management*

- Keep the litter dry and loose.
- Proper hygiene and management can give good results in broilers without the use of preventive drugs.
- Check consumption of feed and water daily.
- Routine examination by post-mortem is very important. If there are oocysts (or other stages) in low numbers, then treat broilers and consider changing over to another preventive drug.
- Take a sample of each feed supply and keep it until the flock has been delivered.

re 3. *drugs against coccidiosis*

Anti-coccidiosis drugs can stop the development of the cycle (= coccidiostatic) or kill one or more stages in the cycle (= coccidiocidal). Most drugs have both actions.

The drugs can act early or late in the cycle. Early-acting drugs are likely to prevent the destruction of mucosal cells in the intestines but may also prevent the development of immunity.

Most drugs act early in the cycle.

Drugs can be used for prevention or for cure. Some drugs can be used in both ways. Most are used in one way only.

Sometimes a combination of drugs is used.

Choice of preventive drugs.

Preventive drugs used during the rearing period of layers (not destined for cages) and of parentstock should permit the development of immunity. For broilers the choice depends on several factors but the main one is the growth-depressing action of most drugs (see table of drugs).

Adult chickens under normal conditions do not need preventive drugs. In several countries (e.g. EU countries) preventive drugs for layers and parentstock are forbidden.

Coccidia preventives are not essential for chicken farming with battery systems.

For broilers, drugs should act early in the cycle and prevent intestine tissue damage.

For rearing birds, however, the drugs should permit the development of immunity.

Drugs do not always give satisfactory results:

- mistakes in the composition of the feed or in the mixing are the cause
- the spectrum of the drug used may be insufficiently broad

- poor hygiene (high infection pressure) or low resistance of the birds (diseases, poor management) may give unsatisfactory results
- the coccidia develop resistance or tolerance to a certain drug

tolerance = a quantitative change in sensitivity; higher doses are necessary

resistance = no longer sensitive; higher doses of the drug do not solve the problem

Resistance of coccidia may appear suddenly or develop slowly (the losses are small at first and gradually increase).

Cross-resistance is normal for drugs within the same group.

Suboptimal doses sooner induce resistance; the same does higher infection pressure.

Species-specific resistance is most common; e.g. a drug loses its activity against *acervulina* but not against other species.

Cocciostatic drugs sooner induce resistance than coccidiocidal.

Resistance is temporary; the sensitivity of the coccidia returns after a shorter or longer time.

Prevention of resistance against drugs.

The most important preventive measure is *proper hygiene and management*.

Change of drugs is essential. To use a drug until the results become disappointing is mis-use of this drug.

Two systems are possible: rotation and shuttle programme, as follows.

shuttle programme:

In the same broiler batch two different drugs are used, one after the other.

The two drugs should not be related chemically.

The first drug should act coccidiocidal and have a broad spectrum; it is given for 3-4 weeks for instance.

The second drug should not cause growth depression.

rotation:

The same drug is used for some consecutive batches of broilers and after this the drug is changed for another.

All drugs have a withdrawal period, i.e. the number of days that should pass after the last treatment and the sale of the birds.

A long withdrawal period may be somewhat risky; therefore in a shuttle programme a drug with a short withdrawal period may be used last.

The ideal coccidial (= drug against coccidiosis)

Unfortunately the ideal coccidial does not exist. All drugs have strong and weak points.

Desirable properties are:

- Relative cheapness.
- Easy quantitative and qualitative determination methods.
- Growth depression must be low. Nearly all drugs depress growth but large differences between drugs exist. Higher doses increase growth depression.
- Low toxicity for the chicken itself, for other animals and for man.
Modern drugs tend to have a smaller margin between 'effective' and 'toxic'.
- No other undesirable effects on the host such as inhibited feather development, watery faeces by extra water consumption.
- No residues in the final product (meat, eggs).
- The drug should permit the development of immunity; this is an important point especially for rearing birds.

- Broad action; all the five important coccidia species should be sensitive.
- Slow development of resistance or tolerance.
- The drug should be stable chemically (during feed storage; during technological processes in feed manufacturing).
 - No electrostatic properties (mixing).
 - No chemical reaction with feed components or other drugs in the feed.
- Easy biological breakdown (degradation).
 - Not toxic for the ecosystem e.g. for plants.

(9.1 adapted from a text written by the late R.T.Haalstra)

9.2 Blackhead (other names: histomoniasis; enterohepatitis)

This disease is also caused by a protozoan parasite.

There is direct transmission by infected water, feed or droppings. Indirectly, the parasite may be transmitted via infected eggs or intestinal worms.

Chickens and turkeys are natural hosts to blackhead infection.

Signs

Affected chickens are depressed, stand or sit with ruffled feathers and have yellowish diarrhoea. The darkening of head parts, especially in turkeys, gave the name to this disease (blackhead). Gross lesions in the liver.

In chickens the mortality is usually limited, young chickens being the most susceptible.

Treatment and control

Medicines against protozoa can be effective.

Drugs can also be given at preventive levels in turkey starter and grower feed.

Growing turkeys on wire and indoors can reduce the incidence of blackhead to a large extent, but strict hygiene and elimination of intestinal worms remain important control measures.

9.3 Worms

When chickens are kept for too long on the same ground, or when wet patches develop in litter houses, the chickens run the risk of a worm infection. In the search for food the chickens may ingest the eggs of worms which all hatch in the intestines.

The disease symptoms are partly those of coccidiosis.

Treatment with medicines is possible.

Keeping the birds on a wire floor prevents a worm infestation.

9.4 Ectoparasites

Parasites *on* chickens are called *ectoparasites*; they can cause problems in chicken farming everywhere. The birds become restless, lose weight and produce less; in severe cases they may even die. Intensive housing as it is practised in modern chicken farming offers the proper conditions for heavy infestations. However, with *proper hygiene a lot of trouble can be avoided in most cases*.

Unlike endoparasites (i.e. living *in* the birds), ectoparasites can also be a problem in houses with wire/slatted floors or battery cages.

In a general way the ectoparasite situation on a chicken farm is an indicator for the level of farm and house hygiene of that farm.

Ectoparasites are also common in extensive 'backyard' chicken farming but here the 'sand bath' of free-ranging chickens is considered to limit the ectoparasite infection in a natural way.

In hot climates ectoparasites are more common and the infections more severe than in temperate climates. The (partial) explanation is the higher environmental temperature which shortens the life-cycle of the ectoparasites.

Ectoparasites multiply faster on weak animals than on healthy and strong animals.

The *most common ectoparasites* are:

- 1 Lice
- 2 Mites and ticks
- 3 Fleas

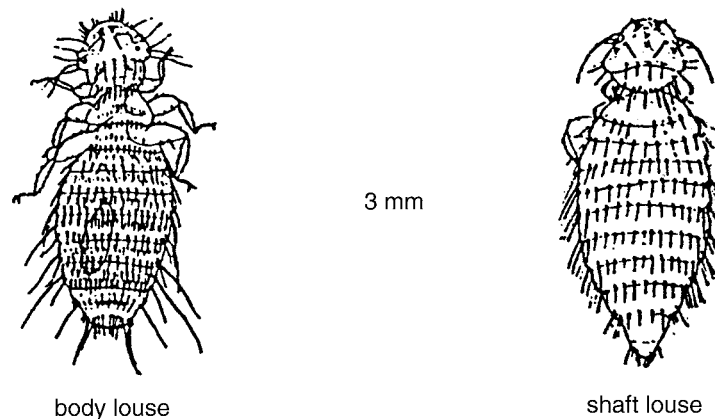

Figure 51: Lice (*Mallophaga*)

Lice are insects without wings.

On chickens they are not blood-sucking but they bite in the skin for food.

Normally the entire life-cycle is spent on the same bird and lasts about three weeks (from egg to adult). The lifespan of lice is several months on the host. Away from the host they can live for about one week.

Lice are easily transmitted through equipment, crates, etc. or through direct contact from bird to bird. There are several kinds of lice (body louse, head louse, wing louse, fluff louse, etc.).

Lice are the easiest to detect; one can see them moving about the base of the fluffy feathers around the vent.

re 2. Mites and ticks (*Arachnida*)

Here the body is not divided into distinct parts like with insects and there is no segmentation of the body.

Mites are by far *the most important ectoparasites* of chickens, in terms of economic losses.

Mites are mainly transmitted by contaminated houses, objects, and persons or by direct contact.

They are not very host-specific.

A distinction should be made between:

1 mites permanently on the body of a chicken

- The *tropical fowl feather mite* is a very common parasite in warm climates and is harmful by sucking blood.

Most eggs are laid in the litter, especially in the litter of nests. The nymphs and the adults feed on the bird. They have a brownish colour when filled with blood.

They are mainly located on the hind part of the back of the chicken.

The control of blood-sucking mites is very difficult and should concern the bird, the litter and the equipment.

- The *northern fowl feather mite* is the most important ectoparasite in many temperate climate countries.
There are other species of feather mites but they are less common and less harmful.
Other mites are the shaft mite (‘depluming itch’) and the scalyleg mite.

2 *mites and ticks visiting the host*

- The *red mite* (roost mite) is well known all over the world. The eggs are laid in crevices and cracks of the house. The nymphs take one bloodmeal on a bird and return to crevices to moult. Adults take bloodmeals only during the night and hide away from the birds during day-time, in dark places (the red mite hates light!).
Adults can live up to six months without a bloodmeal.
Red mites suck much blood and can cause anaemia and even death in brooding young chickens.
- The *fowl tick* is widely distributed in tropical and subtropical countries. Its size is 5 mm (males) and 10 mm (females).
Fowl ticks also suck blood during the night. Larvae, nymphs and adults hide in crevices and cracks.
Adult females may live away from a host without a bloodmeal during more than four years!

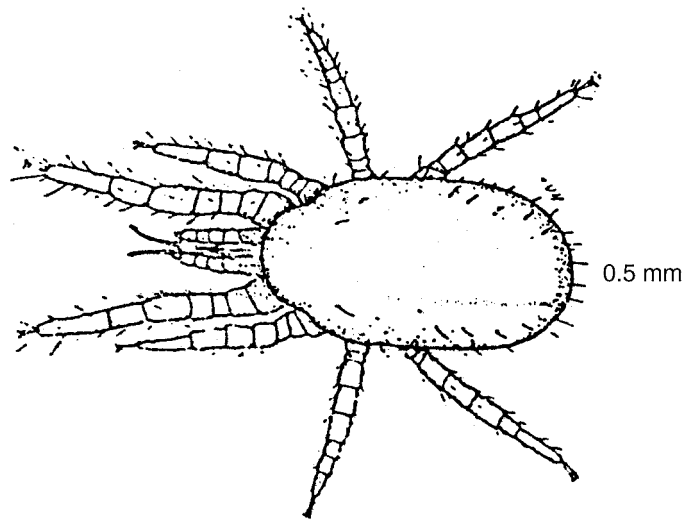

Figure 52: Red mite

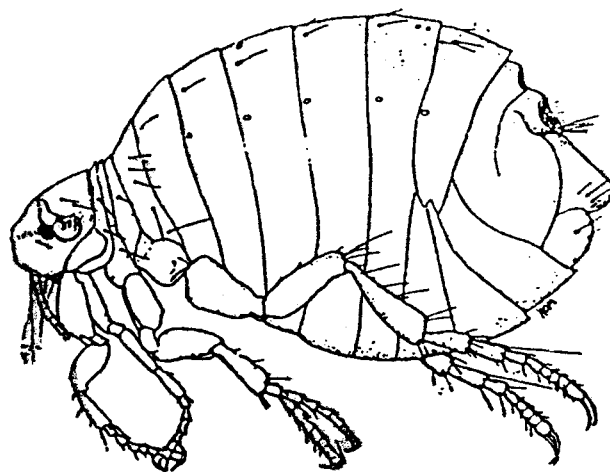

Figure 53: Flea

Fleas are wingless insects with compressed bodies. They have long legs for jumping.
Fleas are not very host-specific.
When not on the host, they live in crevices, cracks of boarded floors, in dirt and debris.
Unfed fleas do not survive in dry places, but they can survive for several months in moist places.
Fleas are troublesome, especially to laying hens.
They breed in litter and in nests.

9.4.1 Ectoparasite control

The control of ectoparasites should be wide-ranging:

- cleaning and disinfection of chicken houses immediately after the evacuation of a flock
- buying birds from a reliable supplier (parasite-free)
- farm and house hygiene
- routine checks every four weeks
- treatment (preventive and when ectoparasites are present)

These points are further discussed (below).

Cleaning and disinfection

Cleaning and disinfection of chicken houses has been discussed elsewhere in this guide.
If it is known that ectoparasites were present in the flock (through routine checks), special measures for disinfection should be taken *after* the house has been cleaned and disinfected in the normal (and proper) way.
This disinfection should be done twice because the ectoparasite transmission from one flock to the other is mainly through the house.

Buying birds from a reliable supplier

Reputable hatcheries sell day-old chicks free from ectoparasites.
The transport should be hygienic and straight from the hatchery to the farm.
If chickens of a certain age are bought then it is very wise practice to inspect the birds. If necessary the chickens should be treated before they enter into the clean house.
It is clear that adding a few new birds (cocks) to a flock is very risky in this respect; they should be treated for ectoparasites (and endoparasites) preferably twice, in a quarantine house.

Farm and house hygiene

Special attention should be given to have the house wild-bird proof.
Houses should have as little as possible crevices and cracks and slats should be easy to detach (improve the situation if necessary).
The painting of perches, slats and wooden parts with creosote is a proper thing to do. After cleaning, metal cages can be treated with kerosene which kills parasites and protects the metal against rust.
In houses with perches, the perches can be suspended from the roof by wires passing through cups with oil which will prevent ticks or mites to reach the birds during the night.

Routine checks every four weeks

Of each flock a minimum of five birds should be inspected. If a bird is found positive, inspection can stop and treatment has to start as soon as possible.
Inspect the chickens preferably outside, in broad daylight.
Open the feather cover by blowing and by the fingers. Birds with ectoparasites often have much dirt and dust inside their feather cover.
Look everywhere and give special attention to the hind part of the back, the surrounding of the vent, under the wings, and to places with broken or rough feathers.
Look for quick- and slow moving lice and mites and for their eggs, deposited singly or in clusters on the feathers or on their base.

Mites can be found moving on collected eggs.

A microscope (magn. 40-100 x) or a magnifying glass are necessary for feather mite inspection.

The red mite is not present on birds during daytime.

Inspect by making a rubbing movement under the batteries, perches, and laying nests. In case of large numbers of red mite the fingers get sticky by blood. There is also a peculiar smell. Small numbers can be seen walking over the fingers.

When should the *presence of ectoparasites* be suspected:

- broken feathers, rough feathers, feather cover not shiny, sometimes skin inflammation, red places where ticks have fed; but:
 - good layers have worn feathers during the second half of the laying period, especially on the tail
 - small battery cages cause worn feathers
 - female parentstock have worn feathers on the back caused by mating
- anaemia, especially in case of blood-sucking mites; the red mite can cause extreme anaemia and sudden death (at night birds die in nest or on perch)
- unrest, increased headshaking, cannibalism, discomfort
- lower egg production, easily 10% decrease; loss of condition

Blood-sucking parasites can transmit diseases when they migrate from one host to another. Examples are fowl pox and fowl cholera.

Young chicks normally suffer more from ectoparasites than older chickens.

9.4.2 Treatment of chickens against ectoparasites

Safety precautions for personnel:

- The inhalation of dust (powder) or mist drops can be very dangerous; use preferably rubber or plastic hand/arm protective cover and wear raincoat (or similar). Not all nose masks provide proper protection.
- For nearly all drugs there is a waiting period before meat or eggs can be safely consumed. Never treat birds (just) before slaughter.

for the birds:

- Buy only reliable products, well-labelled and with precise instructions with regard to use. Read and follow the instructions carefully. Store the product(s) safely, dry, cool and dark.
- Do not combine with other drugs.
- Try to prevent the treatment of sick, weak or stressed birds, and of young birds.
- Treat during the cool part of the day; layers always late in the afternoon.
- Mix thoroughly to get the finest emulsion or suspension. Mix again if there is a resting period in the course of the treatment.
- Only use freshly prepared solutions.
- During spraying, remove feeders and drinkers or have them closed.

for the environment:

- Treat preferably with biodegradable products.
- Discard remains carefully or better, try to use them to treat the animal environment to support the actual treatment of the birds.
- Prevent contamination of fishwater and the environment of other (useful) animals including insects.

There are *several ways* to treat chickens; as follows

- 1 spraying the birds
- 2 submerging/dipping
- 3 dusting
- 4 localized treatments

Also the *environment* of the chickens can be treated:

- 5 spraying the house and all the equipment
- 6 mixing drugs in the litter
- 7 painting the perches
- 8 disinfection of empty houses
- 9 or, possibly, a combination (birds + environment)

A discussion follows below.

Spraying the birds

- Make the birds come together (but not too close, no 'heaping'). After spraying, keep the birds 'concentrated' for some time, but moving around, so that they rub the spray fluid into each other's feather cover.
- The spray fluid must penetrate into the feather cover. With a knapsack spray, use maximum pressure (about 5 bar), spray from a short distance and try to reach the whole bird including the cloaca area.
- Quantity of spray fluid (preferably applied lukewarm):
 - 10 litres/250 birds or
 - 10 litres per 5 m² 3-tier battery or
 - 10 litres per 7 m² 2-tier battery or
 - 10 litres per 10 m² 1-tier battery

Some products that can be used are:

- trichlorfon 97% (Nevugon); 15 g/10 litres water
- propetamfos 200 g/litre; 15 ml/10 litres water
- tetrachlorvinfos 50%; 100 g/10 litres water
- carbaryl 50%; 80 g/10 litres water
- cumafos (Asuntol)
- malathion
- stirofos
- pyrethrin + piperonyl butoxide 0.1%
- permethrin
- penvalerate

Submersion/dipping

- Use a drum of about 1 metre height and fill it for about one third.
- Make three quick dipping movements to open the feathers and to make the spray fluid penetrate into the feathers; make the head of the bird go down only by the last movement.
Let the bird drip out over another drum (or wide bowl), by a second person; the run-off fluid can be used again.
- The required fluid quantity is about 10 litres per 50 birds.
Add regularly some new fluid, to keep the level adequate and the activity of the fluid constant.

Some products that can be used are:

- trichlorfon 97%; 10 g/10 litres water
- propetamfos 200 g/litre; 10 ml/10 litres water
- tetrachlorvinfos 50%; 60 g/10 litres water
- carbaryl 50%; 50 g/10 litres water

- cumafos (Asuntol)
- malathion
- stirofos
- pyrethrin + piperonyl butoxide
- permethrin
- penvalerate
- lindane (in special cases)

Dusting (powdering) the birds

- Required quantity 4-5 g per bird.
- Rub the powder into the feather cover. Work above a wide barrel (bowl) to collect falling powder.

Some powders that can be used are:

- carbaryl 50%-5% mixture
- cumafos (Asuntol) 5%
- malathion
- stirofos
- lindane 0.66% (in special cases)

Localized treatments

Localized treatments are mainly applied in the case of mange ('scaly leg'). The loose crusts are removed as much as possible, in order to reach the mites which are deeply hidden in the skin (the crusts should be burnt).

Some products that can be used are:

- dimethyl diphenyldisulfide 20%; paint-brush with the undiluted fluid three times every three days and repeat once after three weeks
- 20% kerosene/80% oil mixture
- sulfur 60/soft soap 30/warm water 4 litres; mainly against depluming mite
- trichlorfon (Neguvon)
- lindane 5%
- lindane undiluted, 2 drops on neck, lower back and wings; gradually reaches most parasites over the whole body. Only in special cases.

Spraying the house and all the equipment

- When there are chickens in a house it is often necessary to treat the environment of the birds. Most common is the weekly treatment of the laying nests together with a change of litter in the nests.
- Quite often a thorough killing of all parasites in the environment is required. After the removal of litter/manure, all the equipment and especially all dark places, cracks and crevices are treated. A high-pressure spray is important in this case. Also hot (boiling) water can be used to kill parasites in cracks and crevices.
- In many cases birds and environment are treated simultaneously. The drugs and their concentrations are then those recommended for spraying birds only (see above).
- If only the environment is sprayed (without the birds), the following products can be used:
 - trichlorfon 97%; 30 g/litre water/100 m²
 - tetrachlorvinfos + dichlorvos mixture
 - malathion 520 g/litre; 400 ml/10 litres water/100 m²
 - dimethoate 200 g/litre; 1 litre/10 litres water/100 m²
 - dimethoate 150 g/litre + fenitrothion 150 g/litre; 0.5 litre/10 litres water/100 m²

Mixing drugs in the litter

Some products that can be used are:

- tetrachlorvinfos 50%; 75 g/10 m²

- carbaryl 50%; 60 g/10 m²
- cumafos (Asuntol) 5%; 70 g/10 m²
- malathion 4%; 10 g/10 m²
- stirofos

Painting the perches

- nicotine sulphate 400 g/litre; 40 ml/m² or lindane 1%; 40 ml/m²

Disinfection of empty chicken house

- If houses are infected with ectoparasites, especially houses that cannot be cleaned properly, a *double* insecticide treatment has to be given after the house and its equipment have been cleaned.
- All products that are used for spraying houses in the presence of birds can also be used for spraying without birds, generally in a higher concentration.

The following products can be used:

- fenitrothion 20 g/litre; 1 litre/20 m²
 - fenthion
 - methoxychlor 120 g/litre; 1 litre/15 litres water/300 m²
 - methoxychlor 30 g/litre + dichlorvos 5 g/litre; 1 litre/20 m²
 - toxaphere
 - lindane 70 g/litre; 90 ml/10 litres water/100 m²
- All wooden parts (e.g. slatted floor) of the house can be painted with crude creosote. This kills and repels parasites and preserves the wood. At least one week of drying is required before chickens can be put in the house.
 - Metal battery cages can be treated with a spray of kerosene or a mixture of kerosene with an insecticide e.g. dichlorvos 550 g/litre, 30 ml + 1 litre kerosene, or kerosene mixed with a pyrethroid. Kerosene is an insecticide and it prevents the rusting of the cages which is important.

Combination of treating birds and environment

- If there are ectoparasites on the birds, the environment is contaminated too. Sometimes, during day-time the ectoparasites are away from their hosts but still in their vicinity.
- This means that in all cases of ectoparasites it is advantageous to clean the environment; to remove dirt, bedding and droppings and to treat the environment with an insecticide. The treatment of the environment prevents infection, re-infection and the spread of infection.
- The treatment of the environment becomes increasingly important from the top down, in the following list:

skin mites	only the treatment of the birds can solve the problem
lice	
fleas	
northern fowl mite	
tropical fowl mite	
red mite	only the treatment of the environment can solve the problem

Choice of treatment and treatment interval

A proper *diagnosis* is important: which parasite or often which parasites are causing health or production problems?

All treatments are mainly effective against *active* parasites. Eggs and moulting stages are not completely killed. This means that generally speaking at least *two* treatments are necessary.

The duration of the life-cycle (time between egg and egg-producing adult stage) should determine the interval between two treatments.

This interval should be a little shorter than the life-cycle.

The duration of the life-cycle is influenced by the environmental temperature: the higher the temperature, the shorter the life-cycle. This partly explains the greater importance of ectoparasites in warm climates.

Also the humidity plays a role in the duration of the life-cycle.

In general, the interval between two treatments should be 7 to 10 days.

Re-infection is also determined by the time period ectoparasites can live away from the host. Ticks and mites are notorious in this respect. This time period plays an important role in the transmission of parasites from one flock to the next flock through infested houses and surroundings. Hence, when deciding about treatment, the future of the farm and of the coming flocks should play an important role.

9.4.3 Pesticides used to control ectoparasites on chickens

The pesticides used include:

- 1 Cholinesterase inhibitors: organophosphates and carbamates
- 2 Pyrethrins and pyrethroids
- 3 Chlorinated hydrocarbons (CHC's)
- 4 Synergists/combinations
- 5 Rest group

re 1. Cholinesterase inhibitors

Nerve poisons. Their action results in (spastic) paralysis of the parasite and of its host in case of intoxication.

Parasites and hosts vary in their susceptibility to the different drugs in this group. The drugs can be more or less selective in their action.

Organophosphates are usually rapidly oxidized and inactivated in the liver of the host.

Toxicity: in man the symptoms are headache, dizziness, vomiting, narrow pupils, sweating, diarrhoea, slow pulse, cyanosis, trembling, convulsions, coma (in that order of seriousness).

The activity of these drugs is additive, hence the concurrent use of two drugs, or use with short intervals, can be dangerous.

Organophosphates are:

- trichlorfos (Neguvon, metrifonate)
 - soluble in water; not stable in watery solution and for that reason the solution can only be used up to 24 hours
 - wait with slaughter for 14 days at least
- dichlorvos
- low solubility in water, highly volatile, is rapidly metabolized and excreted (by the host)
- tetrachlorvinfos
- cumafos (Asuntol)
 - nearly insoluble; used in suspension
- propetamfos (Propexide)
- dimethoate
- fenithrothion
- fenthion
- malathion
 - is one of the safest organophosphates; is also used in man against head lice; 0.5% in pure alcohol rubbed in the hair and washed after 12 hours
- diazinon
 - is a liquid that cannot be mixed with water; used as emulsion
- stirofos

Carbamates:

- carbaryl
 - a cheap product; low solubility in water , moderate degradation

ad 2. Pyrethrins and pyrethroids

Natural pyrethrins are extracts of certain flowers. Their action is rapid but short-lived.

Pyrethroids are synthetic derivatives of natural pyrethrins. They have a stronger action than the natural pyrethrins. They are less toxic for mammals.

Fish are extremely sensitive and bees can lose their sense of orientation.

Absorption through the skin of mammals is low.

- fenvalerate
- permethrin

re 3. Chlorinated hydrocarbons (CHC's)

CHC's mainly act on nerve cells.

This group of drugs is becoming less and less popular because of their persistence (and accumulation) in animal tissues and in the environment in general. Several CHC's are banned in many countries e.g. DDT.

The ones which are still tolerated should not be used for laying hens, on the body or in the house.

Products which are used:

- lindane
 - low solubility in water; is applied as emulsion
- methoxychlor
 - is one of the safest CHC's, but contact with the eyes of the birds is harmful
- toxaphene
 - is reasonably degradable
 - poultry are very sensitive

ad 4. Synergists/combinations

Combinations such as

- dimethoate + fenithrothion
- tetrachlorvinfos + pyrethrins + piperonyl butoxide
- pyrethrins + piperonyl butoxide

Do not 'experiment' with combinations! but follow prescriptions.

ad 5. Rest group

- nicotine sulphate is a very toxic fumigant
- tar derivatives such as creosote
- oil derivatives such as kerosene
- mixtures of sulphur 60, soft soap 30, warm water
- fine dusts: ash, slaked lime powder (fertilizer quality)
- boiling water
- mechanical cleaning with water or vacuum cleaner

10 Waste management

10.1 Chicken droppings

Chicken droppings are the result of feed digestion (including bacterial fermentation) in the intestines, and the addition of dehydrated urine. Hence the quality of the droppings depends on the quality of the feed and the digestion process.

Fresh chicken droppings (or dried droppings) do not have an unpleasant smell; the pH is slightly acid (uric acid in the urine) and the dry matter content of fresh droppings is about 20%.

Normally, infection with pathogens is low. If there are pathogens, the most important are:

- Salmonella - in ruminants Salmonella is killed in the rumen
- Campylobacter - is killed during drying
- Avian tubercle bacteria - only in old, poorly managed flocks
- Listeria - can multiply in wet manure

Composition

The nutritional value of good-quality chicken droppings is (much) higher than that of pigs and ruminants.

Per kg DM in good-quality droppings (indicative values only):

- 250 g crude protein CP (digestibility 80%)
- 15 g crude fat EE
- 300 g sugars NFE
- 200 g crude fibre CF
- 200 g ash (layers 250 g)

Energy content in TDN is 500 g.

Alterations

- added wasted feed, feathers and broken eggs may change the composition of the droppings somewhat
- influence of the litter
- most important is fermentation/decomposition of the organic matter; as follows:
 - in wet litter, up to 45% of the organic matter and 60% of the energy and nitrogen content can get lost; keeping the litter dry is not only preventing diseases but also preserves the valuable organic matter in the litter
 - the temperature of the litter is very important; at 15 °C there is little or no fermentation and at 35 °C fermentation is at its highest level; keeping the litter loose and dry is the only way to prevent heat production
 - as soon as litter becomes warm, the oxygen consumption by micro-organisms is high; in wet litter this results in anaerobic conditions and thus heavy ammonia losses
 - anaerobic decomposition of very wet litter results in toxin/stench production.

Wet litter and rotting manure are **not** suitable for animal feed!

How much droppings do chickens produce:

as a general rule, the fresh dropping production is in weight the same as the feed consumption; hence 100 hens eating 12 kg feed produce 12 kg droppings, with about 20% DM (= 2.4 kg).

Requisites for using chicken droppings as animal feed:

- 1 Only droppings produced from well-balanced, high quality feeds guarantee a high nutritional value:
 - droppings from free range chickens are only useful as fertilizer (crop production, fish ponds).

- 2 Only droppings produced by healthy birds, kept in flocks of the same age, are a safe feed:
 - anti-coccidials are not known to have harmful effects
 - when drugs are used, it is wise to inquire about possible effects
 - during fermentation in the litter most drugs are broken down.
- 3 Fresh droppings daily collected, fed fresh or rapidly dried, have the highest nutritional value and are (reasonably) tasteful for animals. The maximum interval for collection is three days:
 - the regular collection of droppings also prevents flies from becoming a problem in battery houses
 - litter which is kept loose and dry can be considered 'immediate drying of droppings'.
- 4 The droppings should be free of harmful objects: nails, metal wire, glass.
- 5 Litter should be free of dead chicken bodies which can cause botulism:
 - chicken bodies up to the age of three weeks in dry litter dry rapidly and seldom cause botulism.

10.1.1 Drying, preserving and disinfecting chicken droppings

Drying chicken droppings is a proper way to preserve the nutrients in the droppings, to prepare a palatable product and to take care of disinfection. The drying should start in the chicken house already:

- put narrow-mesh matting or slats under the battery
- in case of litter, keep it loose and dry and prevent water leaking from the roof and the entrance of rainwater through doors and floors, etc.

Sundrying

The best is drying up to 15%.

Sundrying is the cheapest and best thing to do when the climate permits sundrying; the UV rays and the heat kill most pathogens:

- it can be done on matting or (black) plastic sheeting
- if possible, dry the droppings in a windy place, to accelerate the drying and to drive away flies
- sundrying can also be accelerated by mixing the droppings with loose materials like rice bran

Making silage

If correctly done, the ensiling results in a very palatable product and pathogens are killed by the low pH. The product can be used after three weeks and can be stored for one year or longer.

But in poor silage *Listeria* bacteria can multiply.

Because of the high protein content and the high calcium content (layer droppings) it is necessary to add readily fermentable carbohydrates such as maize or molasses.

The best DM content is about 50%; too wet results in a high pH and too dry prevents proper packing. 'Packing' (pressure!) is very important, it removes the air (oxygen) and hence prevents heating (and decomposition).

Before ensiling, the droppings or the litter should be screened (sieved) in order to remove lumps. Lumps will spoil the quality of the product.

Make or store the silage in a cool place (shade, soil cover).

possibilities

- Mixing with *fresh maize plants* for silage.
 - 20% droppings/litter based on DM content or about 7% dry droppings/litter based on freshly chopped maize plants
 - Good mixing is essential.
 - The feeding value and silage quality is better than when urea is added as extra nitrogen source.
- Mixing with *harvest remains* such as maize stalks.
 - The stalks should be finely chopped.
 - The addition of 3% molasses or another sugar is necessary.
- Mixing with partially pre-dried *root crops* or their by-products, e.g. cassava.

- Ensiling droppings or litter with only 3% *molasses*.
The droppings should be pre-dried, while litter should be moistened, to reach about 50% DM.

Formalin treatment

Here the moisture content of droppings or litter should be 30% minimum. Per kg droppings DM 7 ml formalin is used; hence 100 kg droppings with 60% DM = 60 kg DM × 7 ml = 0.5 litre formalin (approx.).

Mix thoroughly and put the product in a closed space (e.g. plastic bags) during three hours. After that, mix with molasses (20% on DM basis) to correct the taste.

Formalin treatment has the additional advantage that protein utilization by ruminants is improved.

Aerobic fermentation

The moisture content should be 30-35%. Less than 30% causes carbonization, too much moisture can cause anaerobic rotting.

Make a heap about 1.5 m high. Preferably cover with grass. Let the product ferment for a period of 6 to 8 weeks. The high temperature will kill pathogens and destroy drugs.

There are heavy losses of organic materials; the resulting product is mainly a mineral mixture and a nitrogen source.

Aerobic fermentation is a way to utilize poor wet litter material after it has been partly dried at first.

10.1.2 Utilization of chicken manure

Chicken manure can be used as:

- 1 Fertilizer
- 2 Energy source + fertilizer
- 3 Animal feed / once or twice + fertilizer

fertilizer

Animal manure based partly or completely on the use of balanced rations, contains all the nutrients which a plant needs.

Apart from this, the organic matter and the minerals in the manure strongly stimulate the biological activity in the soil and preserve soil moisture.

energy source + fertilizer

Here biogas production comes into the picture.

However, because of the high concentration of nitrogen and other nutrients, the chicken droppings should first be 'diluted' by low-quality organic material such as straw or (plenty of) litter.

The biogas only uses part of the energy of the droppings. The nitrogen and the minerals in the rest product ('sludge') remain available for soil fertilization or the fertilization of fish ponds.

chicken droppings as animal feed + fertilizer

In principle, droppings of all types of animals can be used to supply part of the nutrients for themselves or for other animal species.

In nature many animals eat fresh droppings of other species or of man. But for practical application there exist technical, hygienic, economic and ethical limitations.

The situation with regard to chicken droppings, however, is rather ideal. The droppings can first be used in ruminant feeds and then, as ruminant manure, to fertilize soils or fish ponds.

In this way intensive chicken farming becomes integrated in a comprehensive animal husbandry/crop production farming system.

chicken droppings as chicken feed

Additions have been used between 5 and 15%, in rations of layers and broilers. But the disadvantages are often greater than the positive effects:

- it is necessary to pasteurize the droppings and this is costly and there may still be health risks
- chicken manure in the ration often leads to wet droppings
- the droppings cannot be re-used because of accumulation of minerals and toxic elements (e.g. Pb and Cd)

chicken droppings as pig feed

The best way is to feed the droppings on the floor so that the pigs can adjust the intake themselves. Depending on live-weight, a quantity between 100 g and 1 kg can be taken up per pig per day. Chicken droppings can be fed to pigs fresh or dried. A chicken house can be put near a pig pen and the pig pen near (or partly over) a fish pond.

In balanced pig rations 5-10% dry droppings can be used.

It should be mentioned here that dead fresh poultry, properly boiled, is an excellent protein source for adult pigs; so mortality in chickens is not a complete loss in this case.

The quality of pig manure is improved by feeding chicken droppings and the pig manure is an excellent fertilizer for soils and fish ponds.

chicken droppings as feed for ruminants

Ruminants can make the best use of chicken droppings.

Dry droppings can supply 50% of the proteins and all the minerals and give production results quite comparable with commercial concentrate feeds. As a nitrogen source, droppings are far superior to urea.

In balanced rations 20-40% droppings are quite in order, the highest percentage for the lower gifts (high yielding dairy cows 20% preferable).

Ruminants appreciate chicken droppings as a palatable feed when it is freshly dried. It can be fed free choice, at a level of 0.5-1% of the bodyweight. Also for calves older than three months dry droppings are a good feed.

As with all feeds, ruminants have to learn to eat chicken droppings; the learning period will last 1 to 3 weeks.

In ruminants fed with roughage only, the droppings will stimulate the roughage intake and raise the production level.

With sheep some caution is necessary because of a possible high copper content of the droppings.

animal manure as fish pond fertilizer

Any type of manure is good for fertilizing fish ponds e.g. ruminants, pigs, chickens and ducks.

Feeding chicken droppings to ruminants or pigs generally increases the value of their manure for fish ponds.

Manure in fish ponds results in plankton production and some direct consumption by fish.

Recommendations:

- use fresh manure, it has the highest value
- fertilize the pond daily
- use no lumps; the best is to disperse the manure with water
- spread the manure evenly over the pond
- daily up to 1 kg manure DM per 100 m² pond surface area
- DM of fresh manure: cattle about 15%, pigs 20% and chickens 20%
- too much manure can cause oxygen shortage in the water

The daily manure gift can also be expressed as 5% manure DM of the actual biomass of the fish. The recommendation is based on a fish yield of 75 kg fish per year per 100 m². The feed conversion rate will be 3 to 4 kg manure DM per kg of fish biomass.

N.B.: see the AGROMISA guides FISH FARMING IN PONDS and INTEGRATED FISH FARMING on this subject.

Conclusion

The most efficient use of chicken droppings is:

first step: feed to ruminants or pigs

second step: use manure as pond fertilizer

third step: use the pond water for the irrigation of agricultural crops or use the dry bottom of the fish pond for plant production

10.2 Control of flies

The favourable conditions in poultry houses with abundant manure quantities encourage the rapid expansion of house fly populations. The insects develop fast in moist places and especially under warm conditions. So drying of manure in the poultry house may partly prevent fly development, but, as they carry many pathogenic germs you should try to get them more definitely under control. That is not easy. House flies have a live span of 2-4 weeks, but in this short time they can multiply rapidly. Eggs become larvae in 1 day. The larvae become pupae in 4-10 days and 3-6 days later they mature and new adult flies appear, which again start to lay eggs within 1-2 days. From egg to egg a complete life cycle can occur in less than 2 weeks, even in 10 days in a humid warm environment.

For an effective fly control **hygiene** is a first requirement. The house fly is a product of filth and poor sanitation. Moisture levels should be kept low. Leaking nipples, for example, may give masses of larvae. Manure removal and proper disposal are the most important steps to start with in an effective control programme. If possible the manure should be removed daily, whereas the manure pits should be regularly disinfected. Keeping the surroundings free of dead birds, rotting feed and broken eggs, all being favourable spots for flies to lay their eggs, is important, but accumulating manure is usually the major source of the problem. Therefore the best approach is to break the breeding cycle in the larval phase in the manure.

The flies breed in many different places. Consequently the first step in control is to survey the area in order to learn where the flies are breeding and to see where they are abundantly present.

Where the infestation is severe it is increasingly becoming clear that the conventional insecticides are not effective any more, either because the flies are so numerous that killed insects are easily replaced by new adults, or that they have become resistant to the insecticides being used. Even spraying of an effective larvicide at the breeding sites may fail due to the development of resistance. Resistance building in the flies may be prevented by using various means. There are chemical means, containing organic phosphor compounds, to smear on surfaces (1-5 m² per 100 m² floor, dependent on the seriousness of the problem), being effective during 4-6 weeks, other organic phosphor compounds, which should be added to the manure, active during 10-14 days, and sprays, active during 4 weeks. Especially with the last ones resistance building is possible, so change means regularly.

A new method involves the use of an insect growth regulator, blended in very small amounts into the feed, as long as a fly problem exists. The active chemical in the feed passes through to the manure, where it kills the fly larvae, thereby eliminating the major source of the fly problem. In combination with proper sanitation and good management such an approach has already appeared to be very successful.

Some fly killing chemicals may flavour meat and eggs. So be careful in choosing the right ones.

11 Incubation and hatching

11.1 Incubation

Table 31: Incubation periods

Hen eggs	21 days	(min. 19 - max. 23)
Duck eggs	30 days	(min. 28 - max. 32)
Turkey eggs	28 days	(min. 26 - max. 29)
Goose eggs	30 days	(min. 28 - max. 32)
Pigeon eggs	18 days	(min. 17 - max. 19)

Artificial incubation is required as soon as larger numbers of chicks (or ducklings, etc.) are needed. In that case it is not practical to make use of a broody hen (or duck, etc.).

The development of a fertile hen egg into a young chick requires:

- 1 a temperature of 37.5 - 39 °C (100 - 103 °F), for three weeks
- 2 a supply of fresh air permitting the (growing) embryo to breathe
- 3 enough humidity to prevent the egg content from drying out in the (warm) incubator
- 4 some movement of the egg to prevent the embryo from sticking to one side of the egg

An incubator must therefore have a:

- source of heat
- thermometer held at egg level
- thermostat to maintain the temperature at 37.5 - 39 °C
- tray which holds the egg steady but allows the movement of air around the eggs
- supply of water to humidify (to moisten) the air in the incubator
- ventilator to provide fresh air and to remove stale air

There is one **golden rule** for artificial incubation and it ought to be prominently displayed in all incubator rooms and hatcheries:

READ AND CARRY OUT THE MAKER'S INSTRUCTIONS

The reason for this is quite simple. The makers base their recommendations on the results of carefully conducted trials under 'field conditions' and what they advise for a particular incubator has been proven sound practice.

If an incubator is operated as recommended and fails to give satisfaction, it is advisable to get the maker's advice and inspection before attempting any modification on a hit-and-miss basis.

If the maker's advice does not result in improvement, and if the temperature and the ventilation are correct, it is advisable to vary the relative humidity until ideal conditions are obtained.

In the tropics, maintaining the right humidity is usually more difficult than maintaining the right temperature.

Since the instructions for use vary from one type of incubator to another, the following discussion is a *general guideline only*.

Temperature

Temperature is the most critical factor in incubation.

The normal temperature of a hen varies between 41.4 and 41.9 °C. The optimal temperature for hatching determined in the centre of the egg is 37.5 to 37.7 °C. Deviations from the optimal hatching temperature cause mortality and affect the time of hatching.

The lower the temperature the later the hatching because of a slower growth rate of the embryo. Also the frequency of so called malpositions of the chicks is increasing with temperature deviations. Generally the eggs are more sensitive to overheating than undercooling.

High temperatures cause higher embryonic mortality, a shorter duration of incubation and leg and navel abnormalities, especially after ten days of incubation. The coinciding low RH causes sticky chickens losing moisture, so that they are more sensitive to lack of water during their first days of life.

Low temperatures will delay hatching time. Navels may be open and infected. Also here characteristics of high RH can be observed: sticky and relatively small chicks.

For most flat-type or still-air incubators the recommended temperature just above the egg is about 39.5 °C.

In modern incubators with forced ventilation the temperature of the air is kept between 37 and 38 degrees C.

In large hatcheries the eggs are transferred from setters to hatching machines (or hatchers) after about 19 days. Generally the temperature is slightly lowered (36-37 degrees) on the 20th and 21st day. In these hatchers actual hatching of the chicks takes place.

Temperature differences within the incubator should be avoided as much as possible.

The following page shows sketches of still-air and forced-draught incubators.

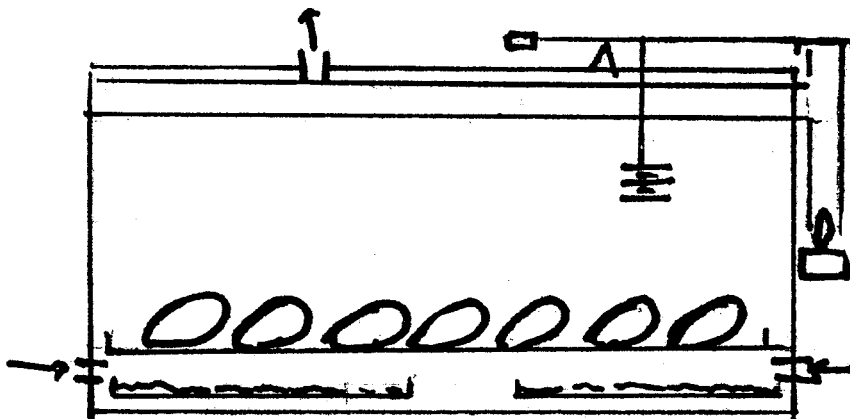

Figure 54: Still-air incubator
– liquid fuel as heat source
– damper allows warm air to enter or escape

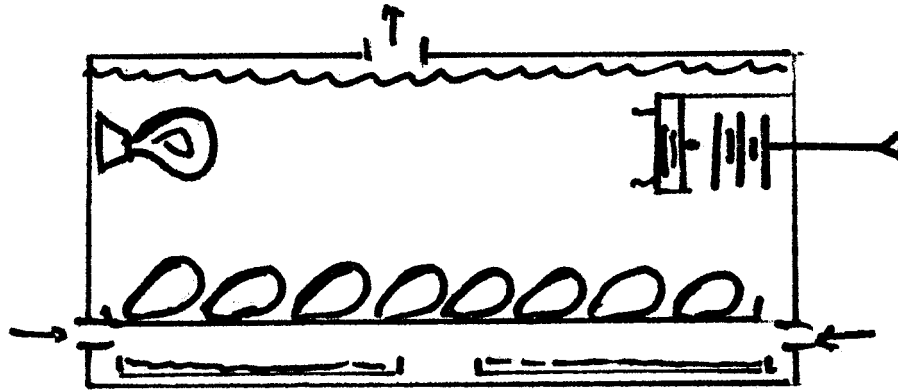

Figure 55: Still-air incubator
 – electricity as heat source
 – micro-switch connects/disconnects the electric current

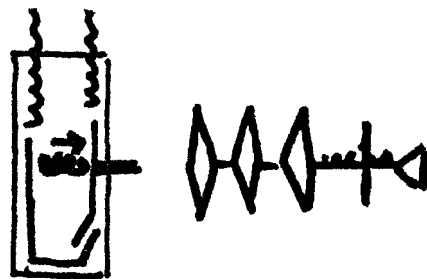

Figure 56: Micro-switch thermostat

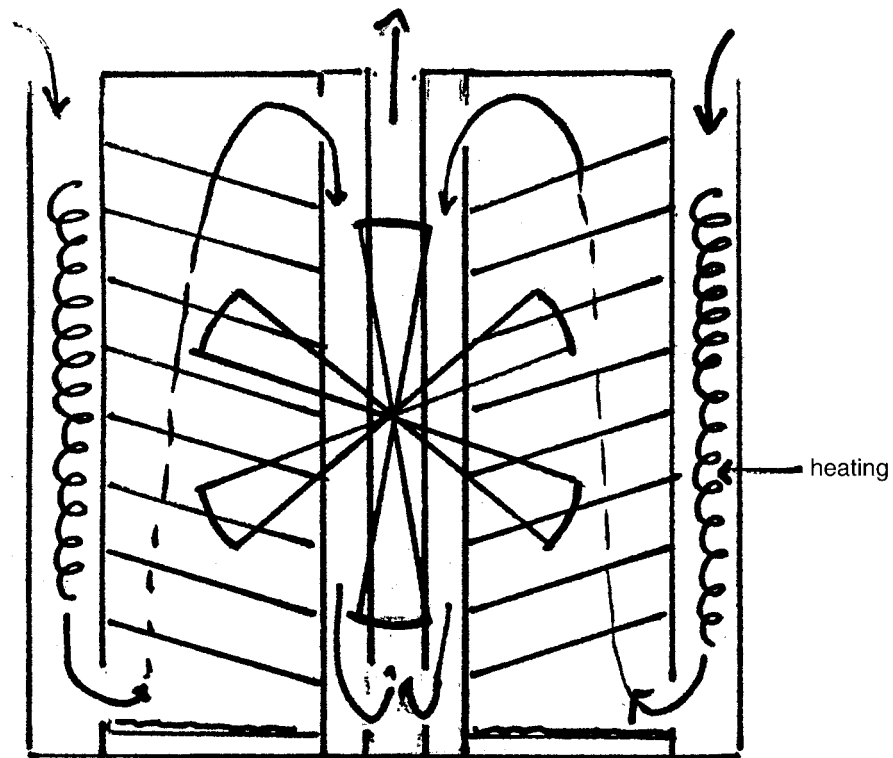

Figure 57: Forced-draught incubator (cabinet type)
 – warm air is forced through the egg trays by the action of a large fan or paddle

Relative humidity

The relative humidity RH is the amount of water vapour in the air expressed as a percentage; 100% means that the air is saturated with water vapour. The warmer the air, the more water vapour it can contain.

Not enough moisture in the air can cause the developing embryo to dry out and die. *Too much* moisture can cause the embryo to ‘drown’.

The relative humidity can be measured by a *hair hygrometer* or *dry-and-wet* bulb thermometer reading. The dry-and-wet bulb reading is the most accurate method of measuring relative humidity but can only be used in forced-draught incubators. For still-air incubators a hair hygrometer is adequate.

Table 32:

		Difference between dry-and-wet bulb readings							
dry bulb reading	°F	1.8	3.6	5.4	7.2	9.0	10.8	12.6	
	°C	1.8	2.0	3.0	4.0	5.0	6.0	7.0	14.48.0
°F	°C	% relatively humidity							
95.00	35.0	94	87	81	75	69	64	59	54
96.8	36.0	94	87	81	75	70	64	59	54
98.6	37.0	94	87	82	76	70	65	60	55
99.5	37.5	94	88	82	76	71	65	60	55
100.4	38.0	94	88	82	76	71	66	61	56
102.2	39.0	94	88	82	77	71	66	61	57

If, for example, the dry bulb reads 37.8 °C (100 °F) and the wet bulb 31 °C (88 °F), this indicates a relative humidity of about 60% (see table).

The following relative humidity percentages have been advised for a still-air incubator: 1st week 40-50%, 2nd week 50-60% and 3rd week 60-65%.

The RH within setters is usually about 50% but it may fluctuate without serious negative effects. Sometimes the RH is a little bit raised during the first three days of incubation (65%), but afterwards it should be lower. Too high RH levels seem to be more harmful than low levels, especially in eggs from older hens. Heavier eggs would benefit from a lower RH.

It is often recommended to increase the RH after the transfer of the eggs to the hatcher. At this stage the moisture loss from the eggs is increasing, so a higher RH seems to make sense. When the first chicks hatch, the RH will automatically increase. Then it should be lowered again, for example to 60%, in order to stimulate the drying process of the chicks.

The humidity in the incubator can be increased by adding water to the reservoir(s) in the incubator, by adjusting the jet spray (in forced-draught incubators), or by spreading a wet cloth under the egg tray. Spraying the eggs with lukewarm water (with germicide) from the 16 th day onwards is sometimes advised.

Turning eggs during incubation

Turning or altering the position of the egg during incubation has a definite influence on the embryo mortality rate. It is necessary for the embryo to be gently but frequently moved within the egg; this prevents the embryo from settling and adhering to certain structures, as it would do if left for 21 days in one position.

In the flat-type incubator turning also ensures more even warming of the egg content.

The turning may be *manual* or *automatic* by means of a mechanical device that can be set to turn the whole of the contents of the incubator at regular intervals. There is much to be said in favour of automatic turning; it is regular, smooth and it can be carried out both during the day and the night without the need of night rounds.

Slow and regular turning is most advantageous in the early stages of incubation.

The intervals between turning can be as short as a quarter of an hour, provided that the eggs are turned in opposite directions each time. If the turning is always done in the same direction it seems to interfere with the centring action of the chalazae and embryonic death may be high.

It has been found that *hourly* turning, throughout the 24 hours of the day, gives the best results.

If the turning is done by hand, the number of turnings may be reduced to 5 or 7 times per day. It is important to turn an odd number of times under such circumstances to ensure that the embryo does not spend the long unturned period of the night always on the same side.

The need for frequent turning is greatest during the first 18 days of incubation.

It is recommended *not* to turn the eggs during the last 3 days. Empty spaces resulting from the removal of eggs should be filled with paper balls or something like that. The eggs should now be completely at rest, since the chick inside is choosing its final position and any disturbance can be fatal.

In the flat-type incubator eggs usually lie flat. In cabinet-type incubators eggs are usually set with the blunt end up, and are turned by tilting the trays through 90°, for instance 45° each side of the vertical.

Ventilation

Adequate ventilation is of great importance during incubation. It is not only the supply of oxygen to the developing embryo that matters, but also the removal of waste products such as carbon dioxide. The air flow should never pass back from 'dirty' areas such as hatchers, to 'clean' areas such as setters and egg holding rooms.

Ventilation is usually assured through holes near the bottom of the incubator which serve as *inlets*, and adjustable *outlets* near the top of the incubator. Bigger incubators usually have a fan or paddle as well (forced-air ventilation).

The incubator *room* must be well-ventilated too, because it is from here that the incubator draws its supply of fresh air.

Air inlets to the incubator must be baffled to prevent draughts.

The incubator room

The *incubator room* is almost as important as the incubator itself. Points to be considered are:

- very good *insulation* to avoid fluctuations in the environmental temperature (the temperature outside the incubator)
- ventilation readily *adjustable* to varying outside conditions
- a smoothly surfaced floor, wall and ceiling that can be cleaned and disinfected easily

Cleaning and disinfection

After a general brushing and cleaning, the incubator itself and all parts and tools used are *disinfected before each incubation*. This is done by *fumigation* with formaldehyde gas:

- for each cubic metre of air space in the incubator, 30 ml of a 40% solution of formalin (HCOH) is poured over 20 g of potassium permanganate (KMnO₄), in a large porcelain dish

After this, the incubator should be sealed for 12 hours. Inhalation of the gas that develops from the permanganate is *very dangerous* for humans.

Steps that must be taken before starting incubation:

- 1 select a suitable room for incubation
- 2 clean the incubator
- 3 measure the volume of the incubator (number of cubic metres), weigh a quantity of KMnO₄ corresponding with the volume of the incubator, make sure that all ventilation holes in the incubator are

closed, measure the right quantity of formalin and pour it over the potassium permanganate; close the incubator quickly!

- 4 twelve hours later the incubator can be opened again so that the toxic gas can escape ventilate the incubator room so that all the gas can escape outside; do not inhale the gas because it is toxic
- 5 make sure that the incubator stands horizontally
- 6 adjust (set) the thermostat until the temperature inside the incubator remains constant at 37.5 to 38 °C; this will take 3 to 5 hours; the thermostat should not be adjusted again after it has been finally set, unless severe fluctuations in temperature occur
- 7 check the incubator regularly, for instance at 6 a.m. - 10 a.m. - 2 p.m. - 6 p.m. - 10 p.m. each time write down (record) the temperature and the relative humidity that have been observed (readings)

Selection of hatching eggs

Hatching eggs should be first-class, fertilized eggs.

There is no way yet of checking the fertility before incubation, but the practices outlined below will help to eliminate possible failures.

Guidelines:

- only first class eggs should be used; all eggs with obvious abnormalities should be rejected
- misformed eggs do not hatch well
- broken or cracked eggs are useless because they dry out inside the incubator
- small eggs usually give weak chicks
- long eggs are mostly 'double yolks' which will never hatch
- abnormally coloured eggs are usually the result of a genetic defect

There are specific egg-weights for each type of chicken according to their production season, but in general a hatching egg should weigh between 52 and 70 g.

Handle hatching eggs carefully because they are costly!

Candling

All hatching eggs should be *candled* before they are set and any abnormal egg should be rejected.

After one week of incubation the eggs are candled again and sometimes once more after 14 days or before the transfer to the hatching tray (18th day of incubation).

Infertile eggs can be detected at one week after setting. They appear completely clear. Infertile eggs can be used for household purposes or, if there are large quantities, by bakeries (biscuits, etc.)

An egg with a *live* embryo will have a clearly defined air chamber. The embryo is seen as a dark spot situated slightly towards the blunt end of the egg, with a number of radiating red lines; these red lines are the blood vessels ('red spider' stage).

If watched over the candling lamp for a few seconds, the embryo (the dark spot) will be seen to make a jerky movement.

If at first sight nothing is seen when tested at this stage (one week), the egg should be turned slowly; if present, the embryo should now appear.

An *embryo that has died* before this candling (at one week) but *after* several days of incubation, will appear as:

- a large, rather nebulous spot (size of a pea) fixed in a certain position
- a red line running across the egg content ('blood ring')

After 14 to 18 days of incubation an embryo that has died *after* the 7th day will show as a dark, hazy mass, varying in size from one somewhat bigger than a dead embryo at the 7th day of incubation, to one filling most of the egg. The air chamber in all eggs with a dead embryo will be ill-defined and not so easy to see as in eggs with a live embryo.

A *live* embryo at this stage will fill most of the egg, apart from the air chamber which is large and clear. A small, hazy part at the narrow end of the egg can be distinguished.

During candling the eggs should not be left outside the incubator for more than 30 minutes, otherwise they will cool down too much.

Any infertile egg or dead embryo egg should promptly be taken out of the incubator because the contents of such eggs may spoil and contaminate the air inside the incubator and affect the healthy eggs.

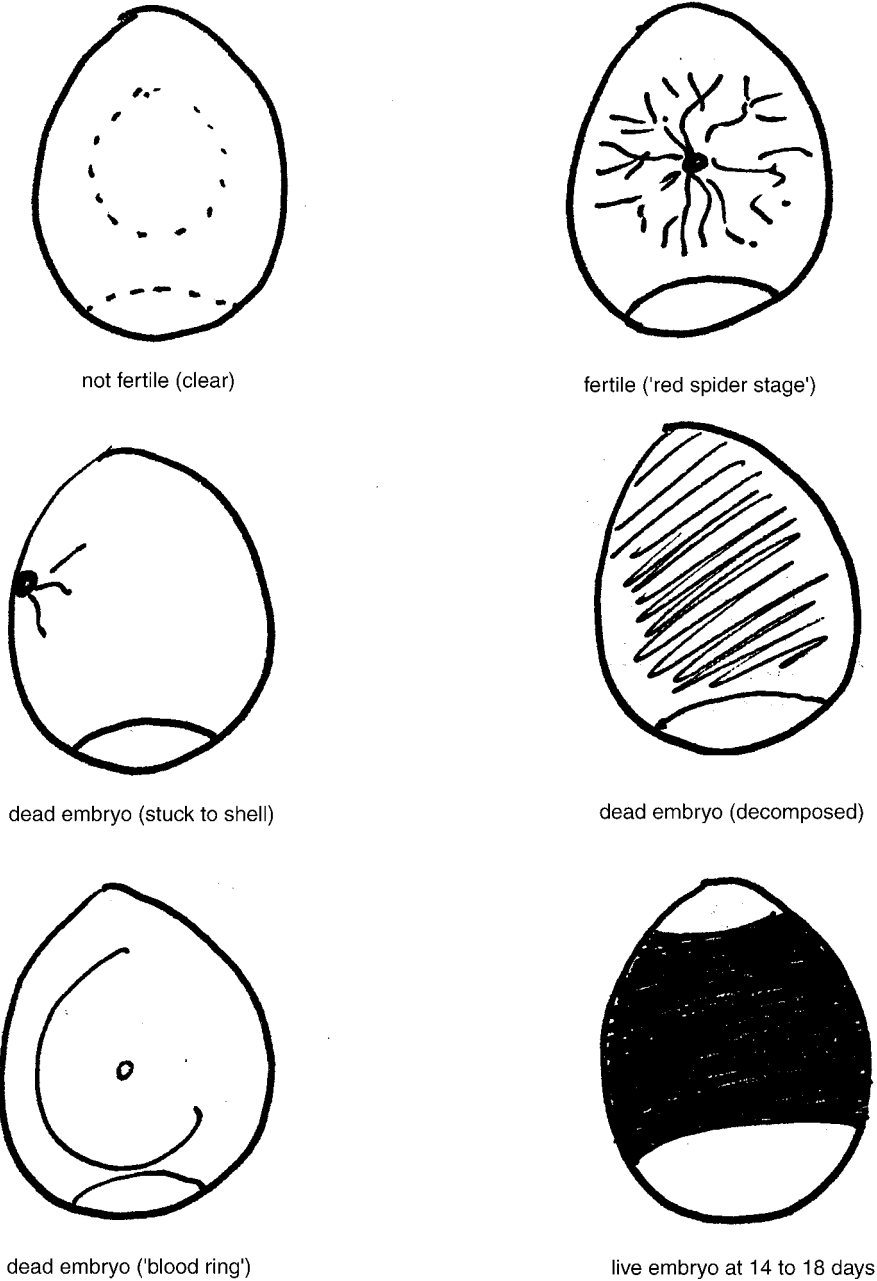

Figure 58: Sketches of eggs

11.2 Hatching and delivery of day-old chicks

After 18 days of incubation (thus on the *19th day*), the eggs are transferred to a hatching tray (but in big incubators the eggs go to a special hatching compartment).

They may be *candled* during this transfer, to detect any dead embryos.

It is often recommended to increase the *humidity* during the hatching.

Ample *ventilation* should be given, since the newly hatched chicks do not only generate a lot of heat but also require plenty of fresh air for breathing.

In some hatching compartments the temperature should be lowered by 1/2 -1 °C. Follow the manufacturer's instructions.

During hatching

When the chick hatches it is rather wet. Chicks must be allowed to dry in the hatcher and to fluff out their down. This is a slow process when the relative humidity is 75% or higher. To speed up this process, the humidity should be lowered again when about 2/3 rd of the chicks have come out of their shells.

Allow approximately 4-5 hours for the drying process, after which the chicks are removed from the hatcher.

Caution: do not leave the chicks in the hatcher too long; this would tend to dry them out too much and the dehydration would lower their vigour and vitality.

Chicks from smaller eggs dehydrate more rapidly than chicks from bigger eggs.

Never help 'late' chicks to hatch by cracking their shells, or by removing chicks from a part of their shell. Such chicks are too weak to become healthy birds and many of them would probably die during the first week.

Chick handling

Freshly hatched chicks often suffer because they are handled several times; this means *stress*.

Make sure that everything is ready and 'in line' to receive the chicks and to dispatch them, so that any handling has not to be done twice, and the chicks are not kept in a certain handling place too long.

The following manipulations may have to be carried out:

Collection

Have collecting trays ready and collect only the chicks that have dried sufficiently. Never place a chick back after it has been inspected.

Do not disturb (or interfere with) the chicks that are not yet ready. Leave them for the second collection which can take place at the latest 12 hours after the first collection.

Two collections will usually be sufficient. Chicks that are not yet ready at the time of the second collection should be discarded.

Hatching should not take longer than 24 hours: the last chicks should be collected not later than 24 hours after the first ones came out of their shell.

Sexing

Hand sexing may be done according to down colour, early and late feathering of the primary and secondary wing feathers, or by using the cloaca method (vent sexing). This is done with very young chicks. Avoid rough handling.

Dewinging

Sometimes the extreme end of one of the wings is cut off, to make the bird unable to fly later on. This dewinging is usually done inside the hatchery. It is done by separating the 'hand' from the 'lower arm' exactly where these two are joined together. It should be done with a hot electric wire, at the place specified above, otherwise bleeding will be severe.

Debeaking

Sometimes chicks are debeaked at the age of day-old. Use an automatic type of debeaker or cut with a *sharp* pair of scissors and/or burn and cauterize both the upper and under beak. Debeaking at this age *requires great skill*.

Vaccinations

Vaccination against Marek's disease usually takes place on the first day, in the hatchery.

Inject muscularly; do not damage blood vessels, nerves or bone tissue.

Spray vaccination against NCD should be done with careful observation of the manufacturer's instructions.

Grading and culling

A definite *quality standard* should be maintained. No chick below the minimum standard should be allowed to go to a customer. The standard should be the same for all breeds and be functional in all seasons of the year.

Do not cut quality when the hatch is poor. Any cut in quality will give your hatchery a bad name!

standards

1 No chick deformities.

All chicks with crooked legs or toes, odd-shaped beaks, eyes missing or gummed up, pasted vents or unhealed navels should be discarded.

2 Above a minimum weight.

The weight of a chick depends on the weight of the egg set and the degree of dehydration of the chick.

Rule of thumb: chick weight at the time of hatching is $\frac{2}{3} \times$ weight of egg set less 1 gram.

Example:

the weight of 100 eggs set was 5400 g

the weight of 100 chicks should then be

$5400 \times \frac{2}{3} = 3600 \text{ g} - 100 \text{ g} = 3500 \text{ gram}$

Chicks that weigh less than the average (= 35 g) should be discarded in this case.

If the total hatch is too light given their set-egg weight, then the chicks are most probably dehydrated. If they are to be shipped over long distances, an intra-abdominal injection with saline solution may be helpful if skilfully applied.

3 Trueness to type.

The down colour should be as expected for the breed or cross, as should be the comb type. Any obvious anomalies, such as incorrect colouring or comb type, should be rejected.

4 Health and vigour are indicated by round, bright eyes, sturdy legs, ability to stand firmly, fluffy down and a lively impression.

Preparing for dispatch

Only *new* and properly constructed boxes should be used; this applies to cardboard boxes. Nowadays plastic boxes are most common; they are returnable.

Adapt the number of chicks per box to the climatic conditions (in hot weather less chicks than in cooler weather).

Whilst waiting for transport, put the boxes on racks or trolleys in a cool and well-ventilated room (20-22 °C preferably).

It is not advisable to subject the chicks to too many manipulations if they have to be shipped over long distances.

Chicks hatched from young breeder birds may have less in reserve (resistance to diseases, moisture) than chicks hatched from older birds (correlation with egg weight). For that reason it is advisable to set the eggs of different age groups apart and keep them separated after hatching. Use the chicks of older flocks if the chicks have to be transported over long distances.

Transport

transport by truck

Prior to loading the truck, make sure that the truck is well cleaned and disinfected and that the fuel tank is filled to capacity, to avoid waiting periods at petrol stations somewhere along the road.

During the loading process make sure that sufficient space remains between the boxes themselves and between the boxes and the sides of the truck. Adequate ventilation should be possible, without actually chilling the chicks. Chicks produce a lot of heat and need fresh air all the time.

Prevent direct sunshine on the boxes.

Make sure that the driver goes straight to the place where the chicks are to be delivered, without any delays. Avoid the rush-hour and diversions, leave breaks for tea or breakfast etc. until off-duty time.

Loading and unloading should be done quickly.

transport by air

departure:

Book for a flight that has, if possible, a direct connection with the place of delivery. Transfers en route tend to be very risky for the chicks.

Ascertain the exact time the aircraft is scheduled to leave. Get to the airport in time to fulfil all formalities.

Probably more chicks die or are damaged at the airport than in the plane. Extreme precautions must be taken:

- the captain of the aircraft should be informed that chicks will be on the plane
- keep chicks in the shade while waiting for handing over or loading
- keep chicks away from draughts, do not allow chick boxes outside in cold weather, or in the sun at any time
- do not cover chick boxes with tarpaulin; never place chick boxes in the corner of a room; keep the boxes in a well-ventilated room inside the cargo building
- do not stack more than 8 boxes on top of each other, otherwise the heat build-up will be too great
- never allow chick boxes to get wet; they collapse when wet (cardboard)
- do not stack other cargo on top of chick boxes; leave air space around the boxes, this is a must; keep boxes level at all times
- have all documents ready before the chicks arrive at the airport (export licence, veterinary certificate, bill of lading, etc.)
- label the chick boxes clearly: place of delivery, person to deliver to, emergency telephone number and address.

arrival:

Allow the chick transport truck to be at the airport one(1) hour prior to the scheduled time of arrival of the aircraft.

Remember that in a plane that has just landed and is not moving, *cooling* to prevent the chicks from becoming overheated is usually a great problem. Therefore the chick load must be transferred to the transport truck as quickly as possible.

In the event that the plane arrives (over one hour) earlier than scheduled and the transport truck is not there, the chick boxes must be removed from the plane to a room with an inside temperature between 20 and 22 °C (if possible). Be sure to maintain sufficient clear space between the chick boxes.

Advise custom officers and health authorities well in advance of place and time of arrival of the chicks, asking them to be present on time so as to get quick action, because everything must be done to assure a speedy move of the chicks to the brooder house.

Arrival on the farm

On arrival the chicks should be unboxed without delay; they are in *immediate* need of the following:

- a temperature of 32-36 °C
- baby chick mash or chick starter
- water at 20 °C
- dry litter free from disease organisms and, if need be, covered with paper
- 23 hours of light daily
- QUIETNESS

More about transport boxes

Chick boxes are made either from cardboard or plastic. Plastic boxes may be re-used (after proper disinfection) but cardboard boxes should be used only once.

After the chicks have been unboxed (placed in the brooder house), the cardboard boxes should be burnt since they are a source of infection. Cardboard boxes should *never* be re-used for the transport of chicks.

Chick boxes vary in size. The number of chicks placed in a box should depend on the temperature outside and the transport distance.

Many boxes of patented design are on the market. Some call for the use of staples to hold them together; others have intricate corner folds that can be snapped together without stapling.

In most cases a box must be kept separate from the box above it. This may be accomplished by gluing a piece of wood (separator) to the cover.

Some boxes have extensions to the box dividers which protrude through and above the lid. The lids act as separators and keep the boxes apart.

Each box holding 100 chicks should be divided into four compartments to prevent the chicks from piling in one corner.

Chicks need something they can hook their toes into, to prevent them from slipping around in the box. Wood-wool is very popular in this respect.

With regard to disease prevention, the boxes and the filling material should be fresh, dry and free from disease germs.

Persons who load and unload chick boxes should use clean outer clothing and footwear. They should make a habit of washing and disinfecting their hands thoroughly before starting work.

12 Non-industrial killing, dressing & packing

Before being killed, the chicken should not eat for about 10 hours. This will empty the intestines and thus prevent the contamination of the carcass at the time of evisceration (should there be accidental rupture).

There are various ways of *killing* poultry, as indicated below.

Dislocation of the neck - bloodless

- hold the bird at the shanks (upper parts of the feet), with the left hand
- hold the neck immediately behind the skull, between first two fingers of the right hand, thumb under lower beak
- extend the neck fully, by moving right hand downwards
- thrust the bird's head downwards with a strong, quick movement; at the same time pull the bird's head backwards over the neck
- the neck is *dislocated* at the junction of the cervical region and the back of the skull

Stunning - brain damage

- the stunner is a piece of iron or other heavy object, rather flat and about 40 cm long
- the bird is held up with the hand by its legs, tail and long feathers of the wings
- give a very sharp rap at the back of the head (just behind the comb) with the edge of the stunner

Using burdizzo forceps (i.e. bloodless castration tool)

- for large fowl such as old cocks, turkeys and geese
- apply immediately behind the head; close the forceps - the jaws dislocate the vertebrae and cut the spinal cord and vein
- the skin remains intact

After stunning or killing poultry by any of the methods described above, the throat should be cut diagonally, as near to the head as possible.

Other methods are:

Cutting the throat

Cutting off the head

- an assistant should hold the bird by its legs, wings and breast and place the head on a block, with the bird facing away from the operator
- cut head off with a heavy, sharp chopper

Brain damage

- the bird is held by an assistant or hung from wire shackles
- take head in left hand and open the mouth
- insert the killing knife and force it upwards where the head joins the neck
- make second incision via the cleft, directly into the brain cavity

Convulsive movements of the bird follow all methods of killing; decapitation (cutting off the head) usually results in a spray of blood.

After killing it is advisable to let the bird bleed so that most of the blood drains from the body. This will improve the quality of the meat.

If the jugular vein of the bird's neck has not been cut by one of the methods of killing, this should be done as quickly as possible afterwards.

To restrain any flapping which may occur, a *killing cone* may be used. It can be placed over a metal trough which will direct the blood to a suitable container. During the bleeding operation the neck should not be held or the flow of blood will be impeded.

Methods of plucking

Dry plucking

This method demands great skill since dry plucking has to be done *within three minutes* after the bird has been killed. Due to brain damage the bird's feathers can be torn out immediately after death. If the plucking takes longer than three minutes the results are disappointing.

Dry plucking is best done in a sitting position and holding the bird by the flanks with its head hanging down to make sure that it bleeds properly. The flight and tail feathers can be removed and kept separate from the body feathers which should be plucked into a box and kept clean and dry if they are going to be sold.

Wet plucking

A. *Semi-scalding* means dipping the bird into water of about 50-55 °C.

The bird should be immersed for 15-30 seconds and vigorously shaken to ensure that the warm water reaches the feather follicles. This will loosen the feathers so that they can be removed without the risk of tearing the skin. Make sure that the temperature of the water does not drop below the indicated range.

B. *Hard-scalding* means dipping the bird into water of about 70-85 °C (the older the bird, the higher the temperature must be).

Do this immediately after killing and bleeding and keep the bird immersed for 30-45 seconds.

This method removes a layer of the skin and if the carcass is allowed to dry it becomes badly discoloured. To avoid this, birds that are plucked in this way should be kept in water until they are packed into a moisture-proof wrapping.

Usually ice is added to this water to help reduce the body temperature as quickly as possible.

This method is not normally suitable for small-scale application.

C. *Wax plucking* is used for ducks.

Suitable paraffin wax is heated in a tank and maintained at 55 °C. A single dip into the molten wax is enough for rough plucking but for complete defeathering it is necessary to dip twice: once for 5-10 seconds and a second time to remove stubs and smaller feathers.

Each time the wax is allowed to set by immersing the carcass in cold water. The wax cast is then cracked and the pieces are removed by hand. The result is an excellent finish and it is usually not necessary to singe birds plucked by this method.

Actual plucking

Plucking should begin on the back and continue down the neck. Grasp the neck in the right hand, the left being placed on the underside near the shoulder, to prevent tearing. Take care not to tear the skin near the crop. The breast is plucked next. Insert the four fingers of the right hand between the legs with the palm downwards and reach up above the vent. Then pull with downward pressure on the end of the breast bone to remove the feathers.

The proper way to pluck the legs and wings is to encircle each leg with the thumb and forefinger and then rub off the feathers with a downward rubbing movement to the shoulders.

Grasp the wing in the left hand close to the body and with the right hand grasp all the long feathers and remove them with one pull.

Then place the right hand around the wing and draw it down; the other wing is done in the same way. The tail feathers are grasped as low as possible and with a quick clockwise motion removed in one action.

Stubbing is made easier by using a blunt knife to remove partly grown or broken feathers.

Hairs can be removed by passing the bird over a flame.

Finishing (complete evisceration)

After plucking it is important to squeeze out any excrement that is still in the vent. Then the head and the feet are cut off.

The following steps are:

- The crop is pulled away from the bird; twist it between the fingers and then pull well in order to loosen the internal organs.
- Cut across the vent, just above the cloaca. Insert the fore-and middle finger, grasp the stomach and withdraw it together with all the intestines and the liver.
A second insertion of the fingers is usually necessary to remove the heart and any other remains.
- Separate the stomach and the liver from the intestines and check their condition. Remove the gall bladder and cut across the stomach. Empty it and remove the inner lining.
Wash and clean stomach, liver and heart and wrap them in a paper.
- Wash the in- and outside of the bird, insert the paper with the stomach, liver and heart.
Insert the end of the neck backwards into the body of the bird or cut it and wrap it inside separately.
- The carcass should be wrapped in a moisture-proof packing (usually plastic bags of a certain thickness are used) and weighed.
Indicate weight and type of bird.

Chilling and freezing

In order to keep the carcass in good condition for as long as possible, it should be cooled down as rapidly as possible, in a refrigerator (room). This will prevent bacterial proliferation.

If the meat is not to be consumed for some time it should then be put in a freezer (temperature below minus 5 °C), in a moisture- and airtight wrapping to prevent rancidity and 'freezer burn'.

The freezer should be kept clean and strongly smelling foods should be stored away from the poultry meat.

Hygiene

The plucker and the finisher should maintain a high standard of hygiene. The same applies to the premises where the poultry processing takes place.

Contamination is harmful to the keeping quality of the product and to public health.

Generally speaking, the more water used the better. Daily cleaning of equipment and premises is essential, using detergents to remove fat and hypochlorite to sterilize working surfaces.

Hand cloths are a source of contamination and should be boiled often. Clean cloths should be given at least at the start of work and at midday.

Changing rooms should be provided and a fresh coat or overall and cap used each day.

Facilities must also be provided to encourage the highest possible standard of personal hygiene.

A close check should be kept on the health of all personnel.

Appendix 1

Professor Louis van der Heide of the Department of Pathobiology, College of Agriculture & Natural Resources, University of Connecticut, USA, has permitted us to reproduce his article entitled EPIDEMIOLOGY OF POULTRY DISEASES UNDER TROPICAL FARMING CONDITIONS IN THE PHILIPPINES (1993).

Although the title refers to the Philippines, the contents is 'tropical' in general. The article reads as follows:

Introduction

The development the poultry industry in the tropical countries of the world has experienced in the last 30 years, is simply astounding. Where in the fifties there were only relatively small poultry houses of generally primitive construction and a population per house of approximately 500-1,000 layers or broilers, growing to a weight of 1.4 kg in 90 days, in the nineties it is not uncommon to see modern chicken houses of 90-120 m long, with approximately 20,000 chickens per house, growing to 1.8 kg weight in less than 45 days.

It could be expected that the health status at these modern farms would be much better than 30 years ago. Generally that is indeed the case, as the level of hygiene and management and the appropriate treatment and prevention methods for many of the common infectious poultry diseases have decreased the incidence of certain diseases such as coccidiosis, and internal and external parasites. Certain bacterial diseases such as coryza, Pasteurellosis (fowl cholera) and histomoniasis (black head) have been gradually reduced in severity and incidence by the use of proper vaccines, chemotherapeutics and antibiotics. Pullorum disease has also been greatly reduced through the importation of pullo- rum-free breeding stock from other countries.

In spite of this progress and improvement, severe outbreaks of infectious diseases in chickens still occur today in the tropical countries, like in the moderate climate countries.

Infectious virus diseases

Severe epizootics of infectious virus diseases, such as Newcastle disease, sweep regularly through the tropical countries of the Far and Middle East as well as South America. Velogenic Newcastle disease has a tendency to reappear periodically at a moment when the poultry producers are just beginning to lose their vigilance and ability to recognize the disease, and the diligence in vaccination might have decreased.

Such outbreaks of velogenic Newcastle disease generally appear by showing an increased mortality with some respiratory or nervous signs or simply depressed and recumbent birds. Post-mortem findings reveal the classical macroscopic and microscopic lesions of velogenic viscerotropic or neuro- tropic Newcastle disease.

In broilers, generally the vaccination against Newcastle disease (ND) are kept at a minimum during periods of clinical absence of the disease. Generally, in broilers a one day old spray vaccination with a repeated spray vaccination at 15-20 days with Hitchner B1 strain of ND vaccine is given during quiet periods without much ND.

As soon as a new outbreak manifests itself, many companies give a day-old vaccination with live ND vaccine spray combined with an injection of inactivated ND vaccine subcutaneously.

These vaccinations in the hatchery are then followed by one, two or even three revaccinations with Hitchner B1 or La Sota type ND vaccine, or even by inoculations with La Sota ND vaccine at 14-18 days and again at 25-30 days.

The problem with Newcastle disease revaccinations is that in many cases it triggers a respiratory reaction that can last for 10-14 days or even longer, depending on the degree of secondary infection with *E.coli* or other bacteria, particularly if the chicks are from *Mycoplasma gallisepticum* (MG) and *Mycoplasma synoviae* (MS) infected breeders. Depending on the climate, these respiratory reactions

lead to growth retardation, unevenness in the flock, higher mortality (up to 15-20%) and condemnation in the processing plant (if meat inspection is practised).

Antibiotic treatment is generally limited in its effectiveness, although widely practised. If antibiotic treatment does not protect the chickens, it will at least protect the caretaker against accusations of negligence.

In addition to Newcastle disease, this respiratory syndrome can also be seen in cases of infectious bronchitis (IB) infections. These can be equally stubborn in the tropical countries as they are in a moderate climate.

Turkey rhinotracheitis (TRT), caused by a pneumovirus, is also widespread in the tropics, frequently demonstrating itself with swollen head syndrome in addition to the respiratory syndrome just described.

In addition to the aforementioned viruses and bacteria, the situation can be greatly compromised by infectious bursal disease (IBD) or Gumboro disease, with its inherent result of immunosuppression. Severe outbreaks of highly pathogenic IBD have recently (this article was written in 1993; editor) occurred in several Far East countries, e.g. Malaysia, Indonesia, Thailand and the Philippines. Mortality of 20-30% has not been uncommon in these outbreaks. Maternal antibody levels in broilers and young layer chickens have frequently been found to be low and variable due to inadequate IBD breeder vaccination. Vaccination of the broilers with IBD vaccine has given variable results which were not always satisfactory. Revaccination of breeders with killed IBD vaccine in mid-lay is generally advocated in many areas. We should recognize here that the health situation in layer chickens as well as in broiler breeders is generally easier to handle, because of a well-programmed vaccination schedule and different management practices in layers (cages) and breeders (better hygiene, less density). Broilers on the other hand create more problems, especially in the vicious cycle of the respiratory syndrome (ND or IB, MG, *E.coli*, IBD), because they have a rapid turnover, are usually grown on the floor (except in many Far East countries), and receive less vaccinations.

It is therefore fair to say that in the present situation one can recognize many if not all of the infectious diseases common to the moderate climate world. Vaccines that are produced from the same virus strains as used in the western countries, and frequently imported from those countries, also do not create a great difference between the tropics and moderate climates.

Poultry management

There remains the difference in temperature. It is fair to say that if properly managed, a tropical climate is not necessarily more difficult to handle than a moderate climate when it comes to poultry management. With proper ventilation, evaporative cooling equipment and adequate roof insulation (with plant or synthetic materials) chickens do just as well in the tropics as in a moderate climate.

Sudden changes in temperature as can be experienced in the summer in the southern United States do much more harm to chickens than a steady warm climate, to which the chicken is acclimatized.

Specific management problems can be observed, for example the phenomenon of brown-outs where electricity supply is interrupted during the daytime, so that ventilation equipment cannot be used and many chickens (particularly broilers) die from heat stroke. Or the introduction of modern tunnel ventilation, where a brown-out causes rapid overheating and suffocation. In those situations it might be better to leave the chicken houses open.

Conclusion

In conclusion, the poultry industry in the tropics, whereby the local chicken was kept in the barnyard or in small, primitive houses, has developed into a modern poultry industry, using the layer and broiler breeds imported from the western countries (USA and Europe). These are being kept in relatively modern housing, while the industry employs present-day disease control and prevention methods, e.g. vaccines, coccidiostats, etc., and even adopts modern management techniques, e.g. dark-out

brooding of breeder pullets, tunnel ventilation and evaporative cooling. These modern techniques have shown remarkable results comparing favourably with moderate climate standards.

End of article.

Appendix 2

One may ask the question: the ‘theory’ of chicken farming as outlined in this guide may be quite in order and useful, but what about the ‘practice’?

Mr. Theo Huber from the Netherlands regularly visits West Africa (Benin, Cameroun), in his capacity as livestock consultant. He has seen various small chicken farms with a few thousand birds, talked with the owners and met prospective chicken farmers or farming groups.

It is interesting to read his observations and recommendations with regard to this type of relatively small-scale chicken farming, under private or collective ownership, particularly women groups.

He discusses the following points:

- 1 Why should one go into chicken farming as an economic enterprise?
- 2 Which factors should be considered before actually starting a chicken farm?
- 3 Which form of enterprise is preferable?
- 4 A guideline for profitability calculations
- 5 Investment guide
- 6 Some data
- 7 Guidance notes for obtaining & maintaining good production levels
- 8 Review

re 1 Why should one go into chicken farming (in West Africa)?

In many warm climate countries the diet is largely vegetarian. Tubers and grains, especially cassava and maize, are very important food crops. Directly consumed they provide high value nutrients to humans. Nevertheless more variation in the diet is desirable and attractive to almost everyone and here the inclusion of (more) animal proteins in the diet comes into the picture.

In the past several attempts have been made to encourage the production of various forms of animal proteins. Until now only few of these (internationally funded) projects were more or less successful. Modern chicken farming is one of them, for the following reasons:

- The keeping of chickens in traditional compounds is well known to many people and has been practised for ages.
- Chicken farming is relatively less demanding and complicated than, for instance, cattle or pig breeding.
- Chicken farming needs a relatively small investment to start with.
- What chicken farming produces (meat and eggs) is very popular on the market; so there is a good demand for its output.
- The control of pests and diseases is possible and relatively easy.
- The chicken farming produce is relatively easy to market; eggs stay fresh for quite some time and chickens (meat) can be transported alive over long distances with relatively simple means (no refrigeration required).

re 2 Which factors should be considered before actually starting a chicken farm?

Before starting a chicken farm it is important to investigate the various factors which will influence on the operation of the farm. In general they can be divided into:

- external factors
- internal factors

External factors

These factors are beyond the control of the chicken farm. They depend on the local market situation for inputs needed by the chicken farm. What is required can be summarized as follows:

- a regular supply of one-day-old chicks
- a regular supply of feed of the right quality
- stable feed prices
- availability of medication

- availability of packing materials, e.g. egg trays

In order to find out what the situation is one should make a market investigation with regard to farm inputs. It is advisable to see different suppliers, check their capacities and meet some of their customers (what is their experience with the supplier?).

In practice there are usually quite a number of problems in this field:

- no properly functioning market organisation with regard to supplies
- shortage of corn (maize meal) causing instable prices
- shortage of other raw materials like soya cake or other feeds with protein
- poor quality of the above feeding materials
- shortage of hatching capacity
- shortage of sufficient parentstock of good quality
- insufficient slaughtering capacity
- insufficient conservation possibilities (cold store capacity)

Because of this suppliers of feed and day-old-chicks seldom meet their contract obligations: deliveries at the right time and in quantities as previously agreed.

This has a negative influences on the results of the chicken farms, and is beyond their capacity to improve the situation (external factors).

Investments are needed to solve these problems. These investment can only be realized if governments, international organisations and banks are willing to co-operate and develop a long term plan. They should support private initiatives already taken in this field.

Internal factors

Internal factors are under control by the chicken farm itself (the management).

As the profitability of a chicken farm is largely a matter of low overhead costs, the management should consist of as few people as possible. For that reason a manager should be capable to carry out various tasks him/herself and be knowledgeable:

- good knowledge of (farm) organisation and finance
- good knowledge of chickens
- be willing to give a helping hand whenever necessary

In this context and if needed, the study of the STOAS' guides on chicken farming and the guide 'the farm as a commercial enterprise' could be helpful.

The quality of the farm buildings is of great importance. Units with a maximum of 2000 chickens are advisable because:

- this diminishes the risk of diseases
- the planning becomes easier
- it is easier to sell slaughtered animals because of smaller numbers at a time
- the chance of obtaining 2000 day-old-chicks is bigger; leading to a better occupation level
- having enough feed in stock because of different age of the chickens

The chicken house must be constructed in such a way that:

- it is easy to clean
- it is easy to enter, without the risk of bringing diseases inside the house
- it is protected against birds and rodents
- it is protected against mosquitos and flies
- it is easy to collect eggs and supply water
- high temperatures are avoided as much as possible

For these reasons it is advisable to construct the walls from mud blocks. These walls should be plastered with cement at least 0.5 m high. The concrete floor must have a smooth surface and have a slight slope to one side. At the lower end of the floor a shallow gutter should be constructed to collect water when the house is cleaned. This gutter should open outside (through the wall).

The roof should be of an open construction to allow heat to escape.

Windows should have shutters. All openings should be screened.

An entrance room annex working room is needed; to prevent the entrance of diseases.

re 3 Which form of enterprise can be recommended?

Generally the chicken farmers in West Africa are private people operating individually. However, forming a co-operation with other farmers in the region can be (very) advantageous with regard to supplies (inputs) and other matters:

- purchase of feed
- purchase of one-day-old chicks
- vaccination and medication
- slaughtering and conservation capacity
- litter production
- a small, common feed factory for all members

The local Chamber of Commerce can advise on the legal form such a co-ordinating organisation should adopt. There are various possibilities. Probably the option with members taking shares in order to finance certain activities (venture capital) is the best. Financing can then be done by shareholders together with banks or other financial institutions.

re 4 Guidelines for profitability calculations

First of all it is necessary to find out the price of (input and output):

- one-day-old chicks
- the various feedstuffs which are on the market
- litter
- chickens on the market (broilers as well as layers)
- electricity per Kw/h
- manure
- packing materials
- transport costs

The above concern variables. It is also necessary to know the fixed costs. Careful bookkeeping is needed, together with experience (see the STOAS guides 'the farm as a commercial enterprise' and 'farm accounting').

re 5 Investment guide

Table 33:

Checklist concerning investments:	Checklist of operation costs (input):	Checklist of output:
1 cost of land	1 purchase one-day-old chicks	1 sale of eggs
2 transport facilities	2 total costs feedstuffs	2 sale of chickens
3 buildings	3 labour (salaries)	3 sale of manure
4 equipment	4 purchase of litter	
5 foundation costs	5 energy costs	
6 sundries	6 depreciation of buildings	
7 unforeseen	7 depreciation miscellaneous	
8 transport costs		
9 vaccination/medication		
10 chemicals		
11 sundries		
12 overhead costs		

re 6 Some data which can serve in profitability calculations

1. Feed consumption per layer cycle over 18 months about 40 kg/layer
2. Feed consumption per broiler cycle over 8 weeks about 2.7 kg/broiler
3. Calculation of manure content of litter = dry material in the droppings.

The litter material must be weighed beforehand. Calculate the total weight of the feed used during the entire period. The weight of 20% of the feed consumption should be added to the weight of the original litter. The certification of the product is a possibility.

4. Basic price calculation on 1st January 2001. One EURO = US dollar 0.9

- a. Building a henhouse for parentstock as described for 1250 hens EURO 9.100

Quite often housing is done as cheaply as possible. Walls are often constructed from raffia sticks. The disadvantage is that such walls give no protection against fires, mosquitos and rodents. Calculations show that the investment in buildings only have a minor effect on the costprice. The depreciation period of a properly constructed building is at least 15 years. On a building suitable for 1250 chickens the depreciation per chicken/year is only 1 EURO.

On the other hand, feeding exactly in accordance to weight and age of the chickens, together with the feed costs, is of crucial importance.

- b. 2000 meat type breeder parentstock and 300 cocks
c&f West African airport EURO 6.400

For common use by co-op or other coordinating organisation:

- c. Egg grading machine; capacity 1.600 eggs/hour
Grading into 7 weight classes Ex works EURO 1.750
- d. Incubator capacity 8.400 hen eggs Ex works EURO 7.750
- e. Hatching machine Ex works EURO 6.600

- f. Refrigeration plant; blast freezer complete with building constructions and:
refrigeration plant / freeze room
refrigeration plant / coldroom
air conditioning / cleanroom
freeze room, blastfreezer and coldstore
machine room, changing rooms, entrance, etc
steel construction with roof
one separate coldstore with refrigeration plant

CIF West African Port works Price including supervision of construction	EURO 500.000
g. Poultry processing plant 400 BPH complete with building and supervision of construction Price ex works	EURO 160.000
h. Machinery for the production of feed, capacity 5 ton/hour c & f West African Port works	EURO 57.000
i. Sea container 20 feet Transport costs without stuffing. C & f	EURO 2.280
j. Refrigeration container 20 feet Electrical operation. Second hand, overhauled. Ex works	EURO 1.600
k. Feed composition; example feed grower 2:	
maize	62%
soya cake	4%
cotton cake	12%
rice bran	10%
palm kernel	4%
concentrate	6%
shell	2%

l. Litter

Litter is always difficult to obtain in sufficient quantities. Empty corn cobs are good basic material for litter. When grinded it gives a good, dry and airy material. Together with droppings it gives good manure (nutrients, structural improvement of soil).

With simple machinery and lay-out a small factory for the production of litter and manure can be realized, giving additional economic activity and profitability for the co-ordinating organisation. Good for possible shareholders.

re 8 Guidance notes for obtaining & maintaining good production levels

It is advisable to make an accurate description of the routine work that has to be done on a chicken farm. In the form of written procedures with regard to the execution of daily, weekly, monthly and yearly activities to be carried out. At the same time it is advisable to explain the standard measures which have to be taken when something goes wrong (feeding, watering, health, etc.). In such a plan there should be 'control points' (= when does the situation deviate from the 'normal').

Examples

Daily routine

- Feeding; time and quantities.
- Watering. Water is not clean; action cleaning of drinkers, disinfection.
- Egg collection. Time and quantity. Rate of laying too low; action (1) check feed quantities, feed analysis, number of chickens alive, visual healthiness, parasites.
- Droppings. Visual check. Diarrhoea? medication, cleaning of water supply.
- Egg weight and shell condition. Too low or too thin. Action: check feed quantity, analyse feed, add shell matter.
- Social behaviour of the chickens. If not normal, check damaged chickens, whether enough drinkers and feeders, pecking.
- Mortality.

Weekly routine

- Average laying percentage, average weight of the chickens, average weight of the eggs.
- Mortality.
- Cleaning of drinkers.
- Parasite check.
- Check colour of yolk.
Make the weekly report.

Monthly routine

- Nest cleaning and add litter.
- Make the monthly report.

If necessary, describe the routine for a period of three, six and twelve months.

It is advisable and of the highest importance to indicate **who is responsible** for the execution of the activities described above.

re 8 Review

During the last five years I investigated the state of affairs of chicken farming in some West African countries. During my stays I interviewed farmers, investigated their business, looked at the market situation and made feasibility studies and gave advice on how to operate a chicken farm.

My conclusion is that under good management and sufficient know-how chicken farming on a professional scale can be profitable.

The problem was often the lack of infrastructure; profitability is then not easily obtained. To my knowledge technical assistance from the West seems never to be structural and concentrated enough; this does not help the situation.

Layers are less profitable than broilers. Broilers also carry less risks because of the short cycles, and the return of capital is faster. Moreover one does not need to market eggs.

If layers are held under proper conditions and management, a profit can be realized. If conditions are not optimal (health, quality and quantity of feed), this profit can easily change into a loss. If all conditions are right, a layer breed is preferable over a dual purpose breed, even when at the end of the cycle the selling price is much lower.

Calculation example based on the Cameroon market

Feed quantity per layer over 18 months	40 kg	126 FF
Extra feed dual purpose breed	4 kg	12.6 FF
Egg production 380 eggs/18 months; dual purpose less 5% eggs = 19 eggs (FF 0.45 per egg)		8.55 FF
Negative difference dual purpose is	$12.6 + 8.55 = 21.15$	FF
Selling price dual purpose after 18 months		20 FF
Selling price layer after 18 months		12 FF
Total difference dual purpose against layer; per bird		13.15 FF

On a flock of 1000 hens the difference is 13150 FF!! This is the difference between a good income or a loss!!

When making a choice with regard to parentstock one should select a breed of which the day-old chicks can be sexed by their colour.

Final remark

Considering everything, also in the tropics successful commercial chicken farming is *a matter of possessing and applying the right skills*. If one cannot meet strict requirements in this respect, it is very difficult to make egg laying profitable.

Stellendam, NL, January 2001
Mr T.Huber (author of this addendum)

DELTA KEY

Voorstraat 27
3251 BB Stellendam, The Netherlands
Tel/fax +31 (0) 187 492131
E-mail <thuber8409@cs.com>

Appendix 3

Other 'farming in the tropics' educational materials, published & distributed by AGROMISA, P.O.Box 41, 6700 AA Wageningen, NL

Farm economics

The farm as a commercial enterprise in a market economy. Elementary instruction followed by universally applicable exercises with answers, so that students gain a working knowledge of the subject. Latest revised edition 2003; 110 pages. To be used with Farm Accounting.

Farm accounting

Instruction and exercises. 50 pages, latest revised edition 2002.

Training elements in smallholder irrigation schemes (basin irrigation)

For junior irrigation personnel and literate farmers. Two volumes, about 200 pages, illustrated. Latest version year 2003.

Book I is about on-farm water management, farmers' participation and water supply.

Book II deals with physical requirements; canals, water distribution, water measurement and finally farmers' organisation.

Practicals for basic land surveying and irrigation

Surface irrigation. Practical for (future) junior field staff and literate farmers. No high-cost equipment requirements. 150 pages, illustrated; latest edition 1999. Source: Larenstein College, with TOOL Amsterdam as co-publisher. One book, in two parts: (1) nine indoor practicals and (2) thirty-six field practicals.

Modern dairy farming in warm climate zones

Information and advice on modern dairy farming, only dealing with what is of direct importance at farm level.

Volume I : dairy cattle feeding; pasture and fodder crops. 115 pages, latest edition (revised) 2002.

Volume II: hand milking and machine milking; milk composition, quality and handling on the farm. 127 pages, fully revised in 1994, latest version 2003. One might say that this volume is applicable world-wide: the milking machine equipment described is basic (not 'the latest' in auxiliary equipment) and used everywhere. With practical lessons to make the text more suitable for training purposes.

Volume III: health and diseases, calf rearing, herd administration, housing and suggestions for practicals in dairy farming training. 75 pages, revised in 1995, latest version 2001.

Video production on hand milking of dairy cows

This video programme shows how hand milking should be done: correctly, efficiently and under hygienic conditions. The following subjects are treated: the role of the oxytocin hormone, the way the cow should be treated, the cleaning/disinfection of equipment, udder cleaning and the milking technique. The procedures (manipulations) shown are supplemented by animations.

Length 13 minutes. A 1993 STOAS production.

Reproduction in dairy cattle

There are two books and one video production:

(I) = Basic facts on reproduction in dairy cattle, important to know at farm level.

Illustrated, 70 pages, revised, latest edition 2002.

(II) = Artificial insemination: organisational aspects, administration and techniques, embryo transfer.

Illustrated, 90 pages, revised, latest edition 2002.

(III) = Video production 'embryo transfer in cattle'.
Length 28 minutes. A 1994 STOAS production.

Foot care in cattle

This guide illustrates and explains hoof problems in modern dairy farming. Prevention and care of hoof problems. In English and French; photographs, 50 pages, year 2000.

Video production on functional hoof trimming of dairy cows

Hoof trimming can prevent problems. Anatomy of the claw, the equipment that is required, trimming itself.

Length 15 minutes; year 2000

Fish farming in tropical fresh water ponds

This manual introduces the basic principles of fish farming in ponds in the tropics. The text was prepared by a VSO aquaculture team working in agricultural education in Thailand. Undergraduate level.

The partner volume is 'integrated fish farming in the tropics'.

Latest version year 2000; 230 pages (the two volumes together).

Basic calculations in agriculture and animal production

The guide begins with basic arithmetic and continues with averages, use of some formulae, proportion and scale, graphs and diagrams and the conversion of units. The second part gives calculations needed for irrigation, crop growing and animal husbandry. Exercises with answers, for use in groups or for self-tuition.

Latest version 2002; illustrated, 80 pages.

More titles are available.