

#### APPLICATION NOTE 3501

## Rechargeable Batteries: Basics, Pitfalls, and Safe Recharging Practices

*This overview of charging methods and current battery technologies gives you a better understanding of the batteries used in portable devices. Nickel-cadmium (NiCd), nickel-metal-hydride (NiMH), and lithium-ion (Li+) battery chemistries are discussed. The article also describes a product that protects single-cell lithium-ion and lithium-polymer batteries.*

### Introduction

The use of batteries has never been greater. Batteries are becoming smaller and lighter, even as they package more energy per unit volume. The main driving force for battery development has been the enormous growth in portable equipment such as mobile phones, laptops, camcorders, and MP3 players. This application note about charging methods and current battery technologies will give you a better understanding of the batteries used in these portable devices.

### Definition of a Battery

Defining a battery merely as an energy storage system requires inclusion of such elements as flywheels and clock springs. In the context of modern technology, however, a more accurate definition says that batteries are usually portable, self-contained chemical systems that produce electrical energy.

One-way batteries, called nonrechargeable or primary cells, create electricity from a chemical reaction that permanently transforms the cell. Discharge of the primary cell leads to a permanent and irreversible change in the cell chemicals. Rechargeable batteries, called secondary cells, however, can be charged by a charger as well as discharged by the application. Thus, secondary cells store, rather than generate energy.

Charge or discharge current is usually expressed (in amperes) as a multiple of the rated capacity, called the C-rate. For example, a C/10 discharge current for a battery rated at one ampere-hour (1Ah) is  $1\text{Ah}/10 = 100\text{mA}$ . The rated capacity of a cell or battery (in Ah or mAh) is the amount of electricity that it can store (produce) when fully charged under specified conditions. Thus, the total energy of a battery is its capacity, multiplied by its voltage, resulting in a measurement of watt-hours.

### Measuring Battery Performance

The chemistry and the design of a battery cell together limit the current it can source. Excluding the practical factors that limit performance, a battery could produce an infinite current, if only briefly. The main impediments to infinite current are the chemicals' basic reaction rates, the cell design, and the area over which the reaction takes place. Some cells inherently produce high currents. Shorting a nickel-cadmium cell, for instance, produces currents high enough to melt metals and start fires. Other batteries can produce only weak currents. The net effect of all chemical and mechanical factors in a battery can be expressed as a single mathematical factor, called the equivalent internal resistance. Lowering the internal resistance enables higher currents.

No battery stores energy forever. It is inevitable that the cell chemicals react and slowly degrade, causing degradation in the charge stored by the battery. The ratio of battery capacity to weight (or size) is called the battery's storage density. High storage density enables the storage of more energy in a cell of given size or weight.

The following tables list nominal voltage and storage density (expressed in watt-hours per kilogram of weight, Wh/kg)

of the major chemistries used in storage batteries for personal computers and cell phones.

**Table 1. Storage Density for Major Storage-Battery Chemistries**

CELL TYPE	NOMINAL VOLTAGE (V)	STORAGE DENSITY (Wh/kg)
Lead acid	2.1	30
Nickel cadmium (NiCd)	1.2	40 to 60
Nickel metal hydride (NiMH)	1.2	60 to 80
Circular lithium ion (Li+)	3.6	90 to 100
Prismatic lithium ion	3.6	100 to 110
Polymer lithium ion	3.6	130 to 150

**Table 2. Characteristics of Major Storage-Battery Chemistries**

Attribute	Nickel Cadmium	Nickel Metal Hydride	Lithium Ion
Energy density	Low	Medium	High
Energy storage	Low	Medium	Medium
Cycle life	High	High	High
Cost	Low	Medium	High
Safety	High	High	Medium
Environment	Low	Medium	Medium

One could ask why not always choose secondary cells, if primary and secondary cells fulfil the same purpose? The answer is, because secondary cells have drawbacks:

- All practical secondary cells lose their electrical charge relatively quickly, through self-discharge.
- Secondary cells must be charged before use.

## Charging Batteries

A new rechargeable battery or battery pack (several batteries in one package) is not guaranteed to be fully charged. It is, in fact, probably nearly discharged. The first thing to do, therefore, is to charge the battery/pack in accordance with the manufacturer's chemistry-dependent guidelines.

Every charging operation applies voltage and current in a sequence that depends on the battery chemistry. Thus, battery-cell chemistries have different requirements that must be met by the charger and the charging algorithm. The terms most commonly found in battery charging are constant current (CC), used for NiCd and NiMH cells, and constant current/constant voltage (CC/CV), applied to Li+ and lithium-polymer cells (**Figures 1-6**).

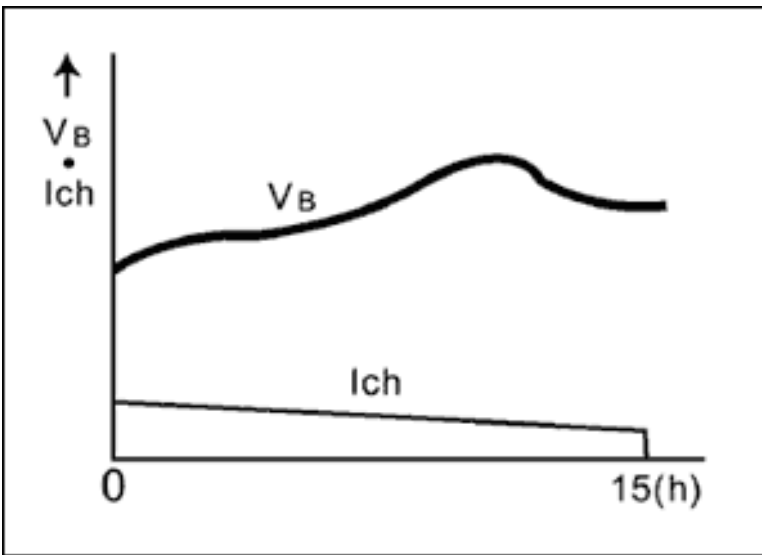

Figure 1. Semi-constant current charging, chiefly used in applications like shavers, digital cordless phones, and toys.

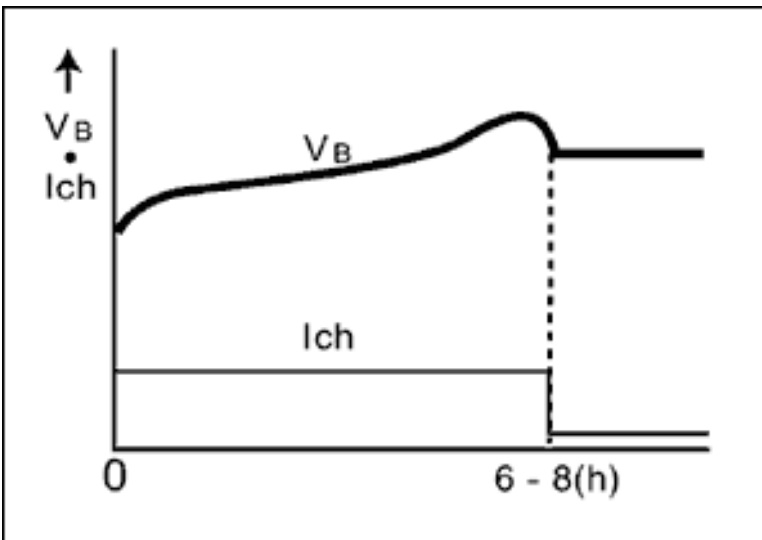

Figure 2. Timer-controlled charging is mainly used in applications like notebooks, data terminals, wireless equipment, and cellular phones.

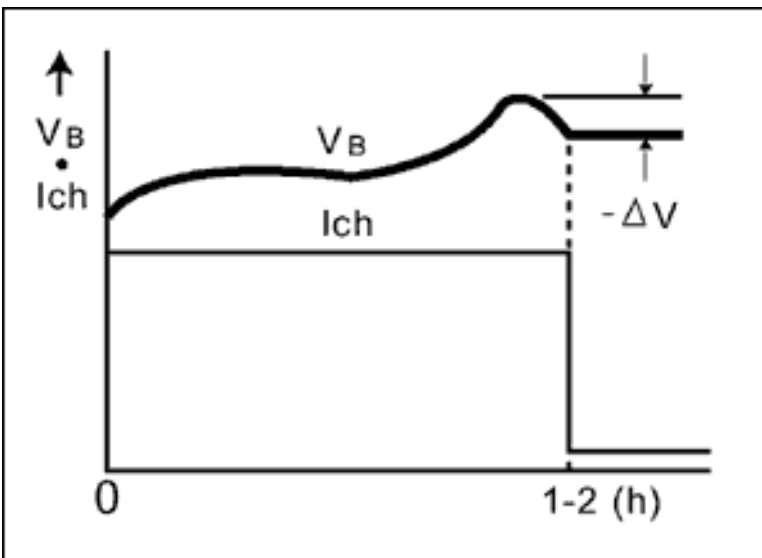

Figure 3. Charging is terminated through  $-DV$  cutoff in applications like notebooks, data terminals, camcorders, wireless equipment, and cellular phones.

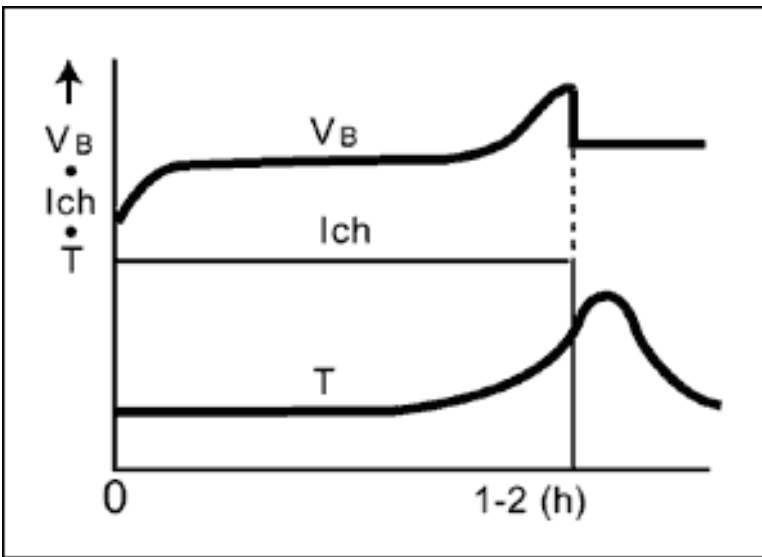

Figure 4. Charging is terminated through  $-dT/dt$  cutoff in applications like power tools and electric tools.

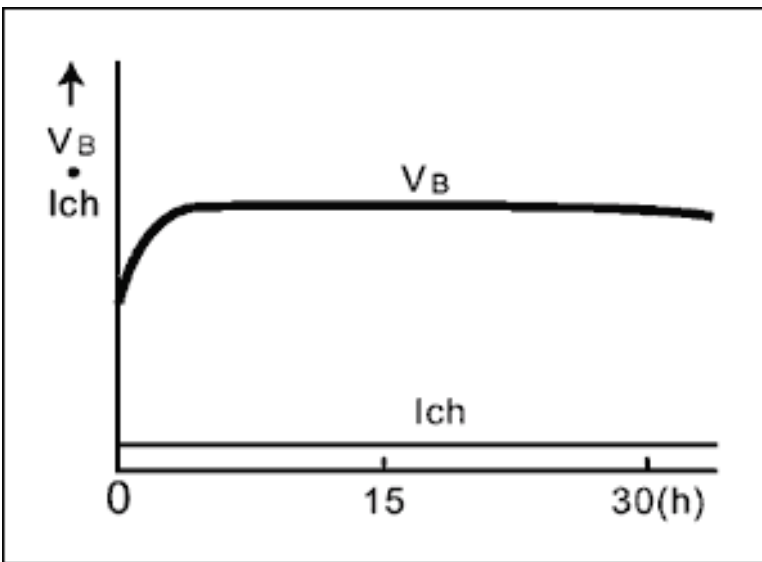

Figure 5. Trickle-charging is mainly used in applications like emergency lights, guide lights, and memory backup.

**Table 3. Charging Methods**

Chemistry	Charging Method	Feature	No. of Terminals	Charge Time (hours)	Charge Current (CmA)	Trickle Current (CmA)	Charge Level at End of Charge (%)	Figure Reference
	Semi-constant current charging	Most typical system; simple and low cost	2	15	0,1	----	----	1
	Timer-controlled charging	More reliable than semiconstant current system; relatively simple and low cost	2	6 to 8	0,2	1/20-1/30	Approx. 120	2

Nickel Based (NiCd and NiMH)	- $\Delta V$ cut-off charging	Most popular; more complex	2	1 to 2	0,5-1	1/20-1/30	Approx. 110 to 120	3
	$\Delta T/\Delta t$ cut-off charging	More costly, but overcharge can be avoided enabling longer life cycle than the others	3 or 4	1 to 2	>1	1/20-1/30	Approx. 100 to 110	4
	Trickle-charging	Simple and low cost; applicable for continuous long charging	2	15	0,1	----	----	5
Lithium Based	Constant current-constant voltage (CC-CV)	Not recommended for the main charge-control system for Ni-Cd /NiMH batteries. Prevailing charge method for Li+ and Li-Polymer batteries. Relatively complex charger design.	2	1 to 3	1	----	Approx 100	6

**Table 4. Determining a Full Charge for Different Cell Chemistries**

Chemistry	NiCd	NiMH	Li+
Charging	Constant current	Constant current	Constant current/constant voltage
Full charge detect	$-\Delta V/dt$ and/or $\Delta T/dt$	$\Delta V/dt = 0$ and/or $\Delta T/dt$	$I_{charge} = eg 0.03C$ and/or time

As shown above, the end-of-charge determination differs according to chemistry and charging technique.

## Charging Nickel-Cadmium Cells

NiCd cells are charged by applying a constant current in the range 0.05C to more than 1C. Some low-cost chargers terminate the charge by means of absolute temperature. Though simple and inexpensive, that charge-termination method is not accurate. A better method terminates a charge when a drop in voltage indicates a full-charge condition. The  $-\Delta V$  phenomenon is most useful for charging NiCd cells at 0.5C or greater. The  $-\Delta V$  end-of-charge detection should be combined with battery-temperature measurement as well, because aging cells and mismatched cells can reduce the voltage delta.

You can achieve more precise full-charge detection by sensing the rate of temperature increase ( $dT/dt$ ). This charge-detection method is less harsh for the battery than is a fixed-temperature cutoff. By avoiding overcharge, a charge termination method based on a combination of  $\Delta T/dt$  and  $-\Delta V$  cut-off enables a longer life-cycle.

Fast charging improves charge efficiency. At 1C, the efficiency is close to 1.1 (91%), and the charge time for an

empty pack will be slightly more than one hour. When applying a 0.1C charge, the efficiency drops to 1.4 (71%) with a charge time of about 14 hours.

Because the charge acceptance of a NiCd battery is close to 100%, almost all energy is absorbed during the initial 70% of charging, and the battery remains cool. Ultra-fast chargers use this phenomenon to charge a battery to the 70 percent level within minutes, applying currents equal to several times the C-rating without heat buildup. Above 70% charge capacity, the charging continues at a lower rate until the battery is fully charged. Eventually, you top off the battery by applying a trickle charge in the range 0.02C to 0.1C.

## Charging Nickel-Metal-Hydride Cells

Though similar to NiCd chargers, a NiMH charger employs the  $\Delta T/dt$  method, by far the best method for charging NiMH cells. The end-of-charge voltage depression for NiMH batteries is smaller, and for small charge rates (below 0.5C, depending on temperature) there may be no voltage depression at all.

New NiMH batteries can show false peaks early in the charge cycle, causing the charger to terminate prematurely. Moreover, an end-of-charge termination solely by  $-\Delta V$  detection almost certainly ensures an overcharge, which, in turn, limits the number of charge/discharge cycles possible before the battery fails.

It seems that there is no  $-dV/dt$  algorithm that works well for charging NiMH batteries under all conditions: new or old, hot or cold, and fully or partly discharged. For that reason, do not charge a NiMH battery with a NiCad charger unless it utilizes the  $dT/dt$  method for end-of-charge termination. Furthermore, because NiMH cells do not absorb overcharge well, the trickle charge must be lower (about 0.05C) than that recommended for NiCd cells.

Slow-charging a NiMH battery is difficult, if not impossible, because the voltage and temperature profiles associated with a C-rate of 0.1C to 0.3C do not provide a sufficiently accurate and unambiguous indication of the full-charge state. The slow charger must therefore rely on a timer to indicate when the charge cycle should be terminated. Thus, to fully charge a NiMH battery you should apply a rapid charge of approximately 1C (or a rate specified by the battery manufacturer), while monitoring both voltage ( $\Delta V=0$ ) and temperature ( $dT/dt$ ) to determine when the charge should be terminated.

## Charging Lithium-Ion and Lithium-Polymer Cells

While chargers for nickel-based batteries are current-limiting devices, chargers for Li<sup>+</sup> batteries limit both voltage and current. The initial Li<sup>+</sup> cells called for a charge-voltage limit of 4.10V/cell. Higher voltage means greater capacity, and cell voltages as high as 4.2V have been achieved by adding chemical additives. Modern Li<sup>+</sup> cells are typically charged to 4.20V with a tolerance of  $\pm 0.05V/cell$ .

Full charge is attained after the terminal voltage reaches the voltage threshold and the charging current drops below 0.03C, which is approximately 3% of  $I_{charge}$  (**Figure 6**). The time required for most chargers to achieve a full charge is about three hours, although some linear chargers claim to charge a Li<sup>+</sup> battery in about one hour. Such chargers usually terminate the charge when the battery's terminal voltage reaches 4.2V. That method of charge determination, however, charges the battery only to 70% of its capacity.

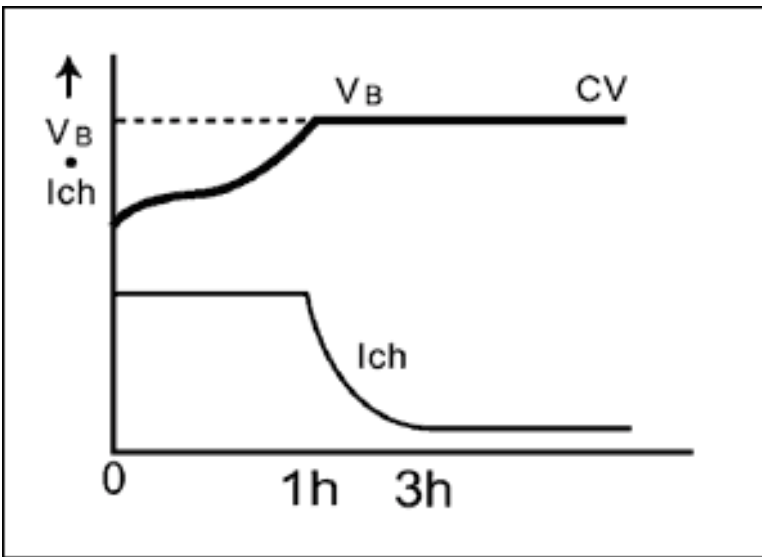

Figure 6. Constant-current, constant-voltage charging is used in applications like cellular phones, wireless equipment, and notebook PCs.

A higher charging current does not shorten the charge time by much. Higher current lets you reach the voltage peak earlier, but then the topping charge takes longer. As a rule, the topping charge will take twice as long as the initial charge.

## Lithium-Ion Safety

Because overcharging or overdischarging a Li<sup>+</sup> cell can cause it to explode and injure people, safety is a major concern when handling this type of storage cell. As a result, commercial Li<sup>+</sup> battery packs contain a protection circuit, such as the DS2720 (Figure 7). The DS2720 provides all the electronic safety functions required for applications that involve rechargeable Li<sup>+</sup> batteries: protection for the battery during charge, protection for the circuit against excess current flow, and maximizing battery life by limiting the level of cell depletion.

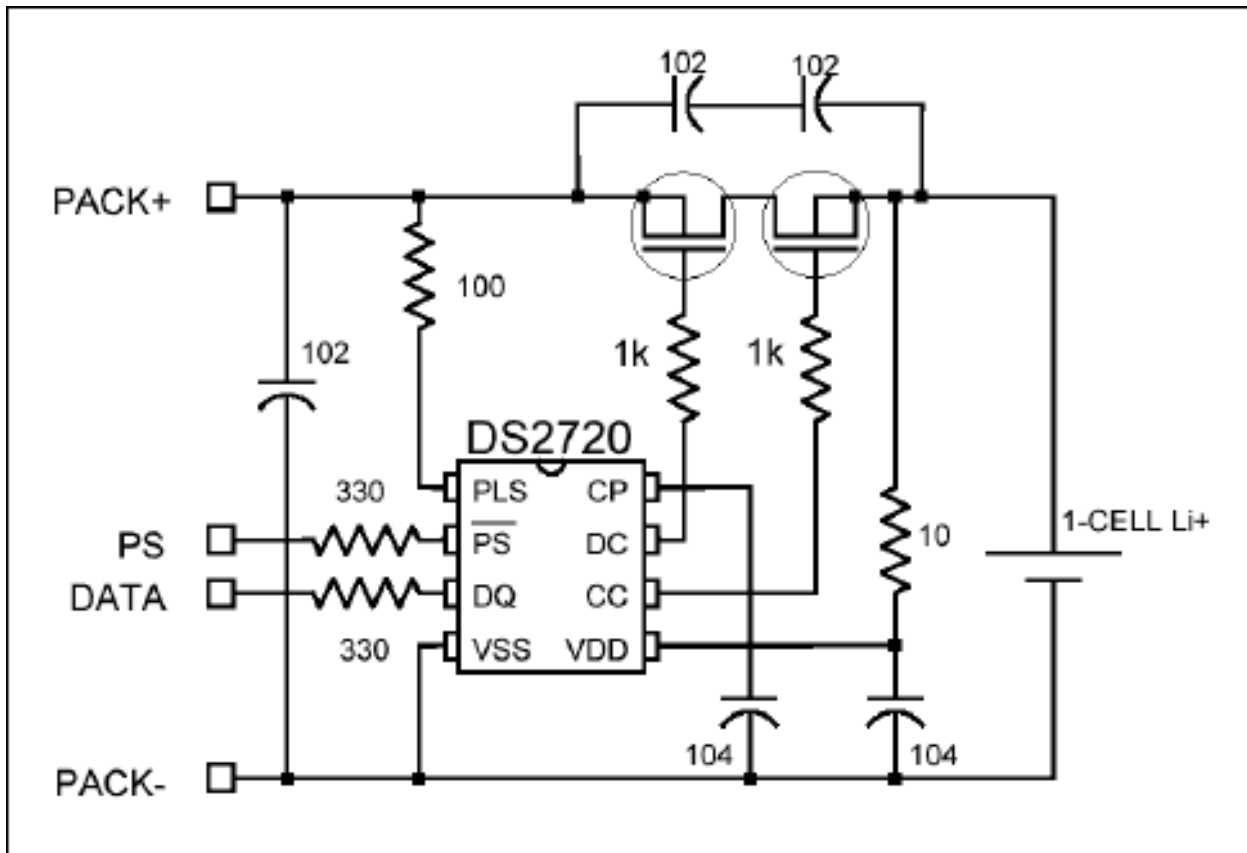

Figure 7. Typical application diagram for the DS2720 lithium-cell protection IC.

DS2720 ICs control the conduction paths for charge and discharge currents with external switching devices such as low-cost n-channel power MOSFETs. The circuit's internal 9V charge pump provides high-side drive to the external n-channel MOSFETs, yielding lower on-resistances than do the same FETs operating in a more common low-side protection circuit. FET on-resistance actually decreases as the battery discharges (**Figure 8**).

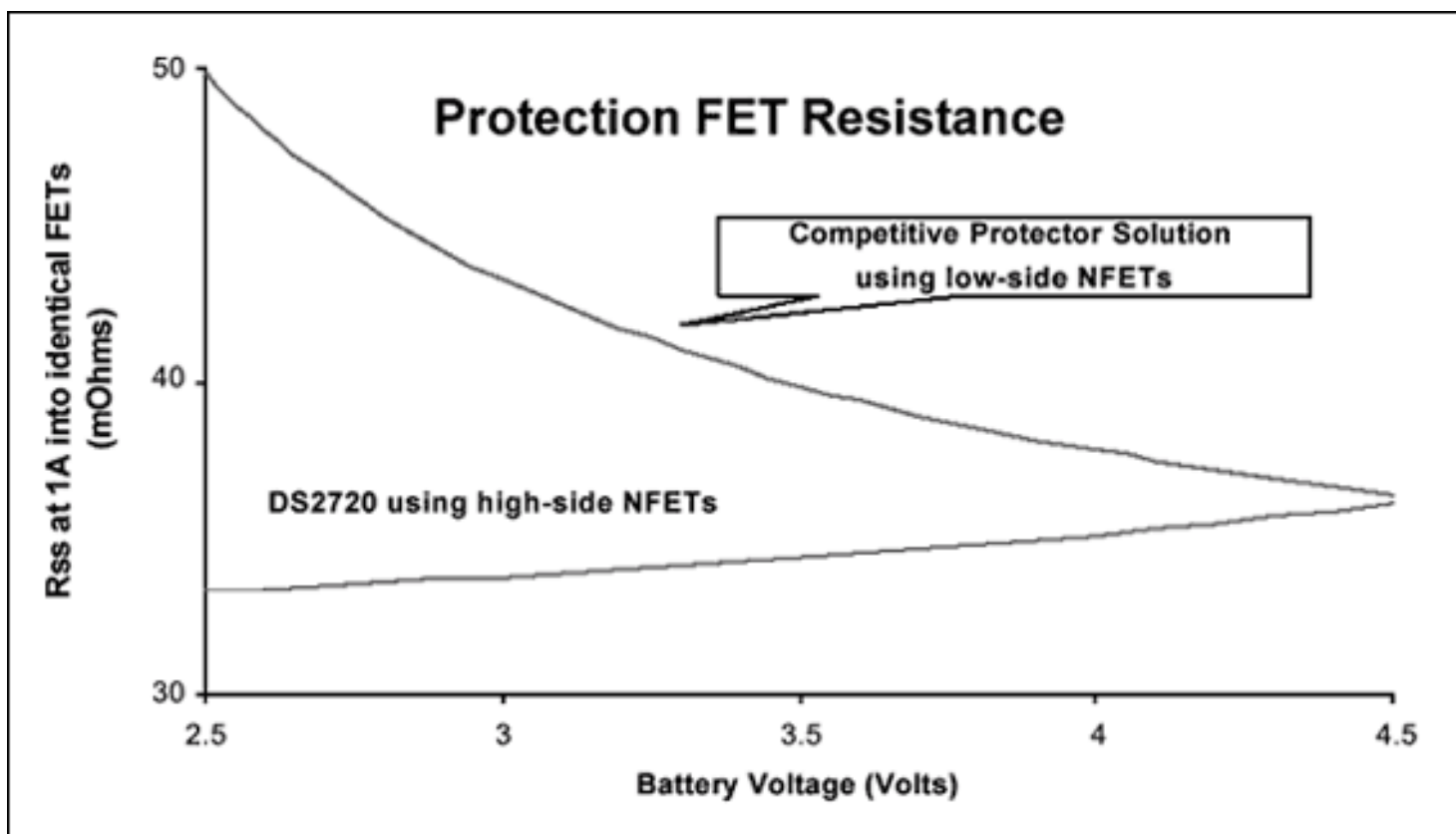

Figure 8. The resistance of protection FETs controlled by the DS2720 in high-side mode is lower than FETs operating in the traditional low-side mode. FET resistance controlled by the DS2720 actually drops with battery voltage.

DS2720's regulated high-side n-FET drive results in lower switch resistance, even at end of discharge. The result is longer runtime for your portable needs.

- Monitors Cell for Over-/Under-Voltage, Overcurrent, and *Overtemperature*
- Regulated Charge Pump Supports High-Side n-Channel MOSFETs
- Integrated Multiple Battery Selector
- 8 Bytes of Lockable User-EEPROM
- 64-Bit Unique Electronic Serial Number
- Low Power: 15 $\mu$ A Active, 1 $\mu$ A Standby
- Available in Tiny 8-Pin MSPO Package
- 1-Wire Data Communication Interface

The DS2720 lets you control the external FETs from the data interface or from a dedicated input, thereby eliminating the redundant power-switch controls otherwise required in a rechargeable Li+ battery system. Through its 1-Wire interface, a DS2720 provides the host system with read/write access to the status and control registers, instrumentation registers, and general-purpose data storage. A factory-programmed 64-bit net address allows each device to be individually addressed by the host system (**Figure 9**).



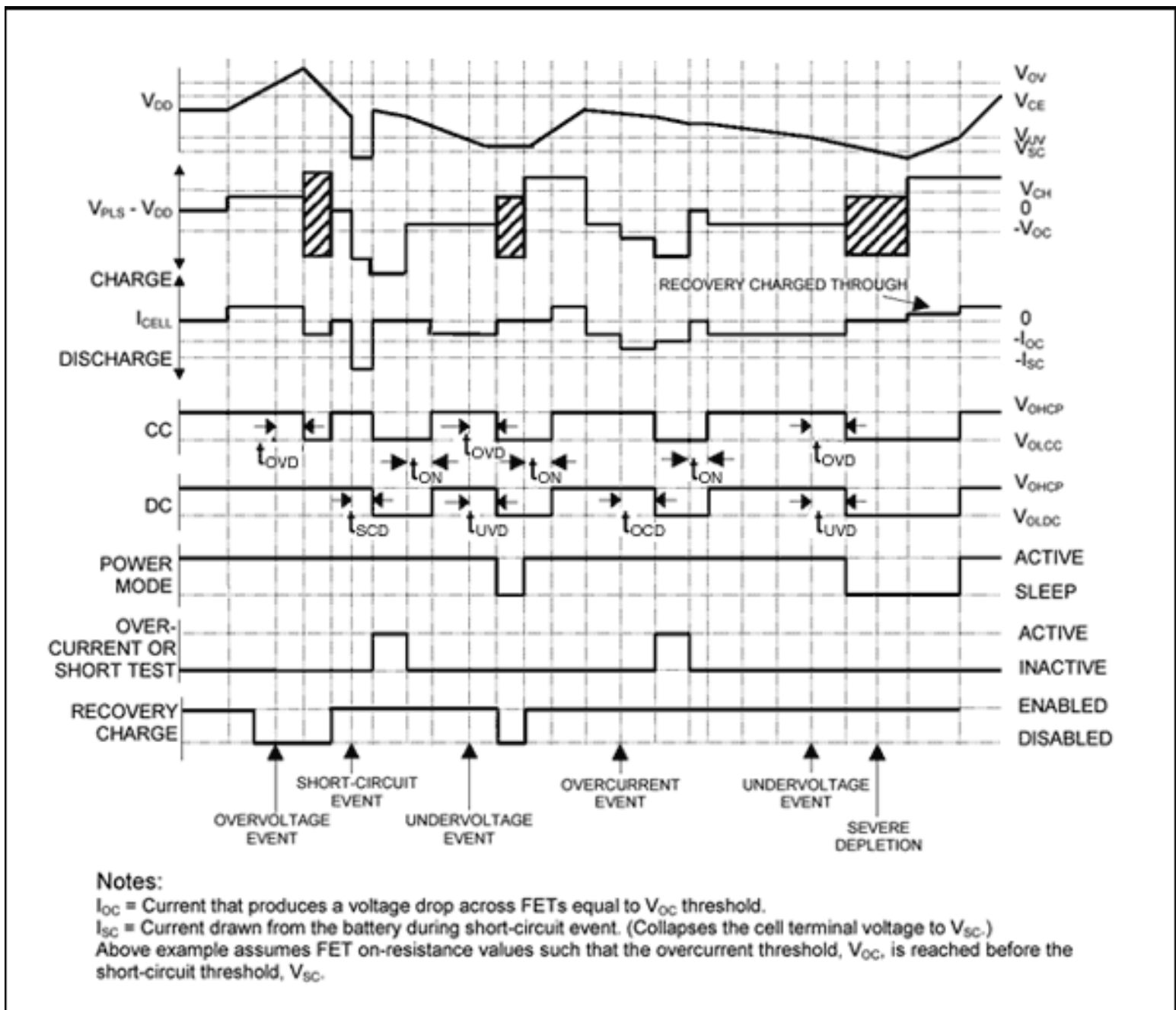

Figure 9. Example waveforms showing Li+ protection by the DS2720.

The DS2720 provides two types of user memory for battery-information storage, EEPROM and lockable EEPROM. EEPROM is a true nonvolatile (NV) memory whose contents (important battery data) remain unaffected by severe battery depletion, accidental shorts, or ESD events. When locked, a lockable EEPROM becomes a read-only memory (ROM) that provides additional security for unchanging battery data.

## Protection Modes

### Overvoltage

If the cell voltage sensed at  $V_{DD}$  exceeds the overvoltage threshold,  $V_{OV}$ , for a period longer than the overvoltage delay,  $t_{OVD}$ , the DS2720 shuts off the external charge FET and sets the OV flag in the protection register. The discharge path remains open during overvoltage. Unless blocked by another protection condition, the charge FET is reenabled when the cell voltage falls below the charge-enable threshold,  $V_{CE}$ , or discharging causes  $V_{DD} - V_{PLS} > V_{OC}$ .

### Undervoltage

If the cell voltage sensed at  $V_{DD}$  drops below the undervoltage threshold,  $V_{UV}$ , for a period longer than the undervoltage delay,  $t_{UVD}$ , the DS2720 shuts off the charge and discharge FETs, sets the UV flag in the protection register, and enters sleep mode. After the cell voltage rises above  $V_{UV}$  and a charger is present, the IC turns on the charge and discharge FETs.

### Short Circuit

If the cell voltage sensed at  $V_{DD}$  drops below the depletion threshold,  $V_{SC}$ , for a period of  $t_{SCD}$ , the DS2720 shuts off the charge and discharge FETs and sets the DOC flag in the protection register. The current path through the charge and discharge FETs is not reestablished until the voltage on PLS rises above  $V_{DD} - V_{OC}$ . The DS2720 provides a test current through internal resistor  $R_{TST}$  (from  $V_{DD}$  to PLS) to pull up PLS when  $V_{DD}$  rises above  $V_{SC}$ . This test current allows the DS2720 to detect the removal of the offending low-impedance load. In addition, the test current enables a recovery charge path through  $R_{TST}$  from PLS to  $V_{DD}$ .

### Overcurrent

If voltage across the protection FETs ( $V_{DD} - V_{PLS}$ ) is greater than  $V_{OC}$  for a period longer than  $t_{OCD}$ , the DS2720 shuts off the external charge and discharge FETs and sets the  $D_{OC}$  flag in the protection register. The current path is not reestablished until the voltage on PLS rises above  $V_{DD} - V_{OC}$ . The DS2720 provides a test current through internal resistor  $R_{TST}$  (from  $V_{DD}$  to PLS) to detect removal of the offending low-impedance load.

### Overtemperature

If the DS2720 temperature exceeds  $T_{MAX}$ , the device immediately shuts off the external charge and discharge FETs. The FETs are not turned back on until two conditions are met: cell temperature drops below  $T_{MAX}$ , and the host resets the OT bit.

### Charging at High and Low Temperatures

Efforts should be made to charge at room temperature. Nickel-based batteries should only be fast-charged between 10°C to 30°C (50°F to 86°F). Below 5°C (41°F) and above 45°C (113°F), the charge acceptance of nickel-based batteries is drastically reduced. Li+ batteries offer reasonably good charge performance throughout the temperature range, but below 5°C (41°F) the charge rate should be less than 1C.

## Summary

NiMH chargers can accommodate NiCd batteries, but not vice versa. Chargers dedicated to NiCd batteries will overcharge a NiMH battery. The cycle life and performance of nickel-based batteries are enhanced by fast charging because fast charging reduces the memory effect from formation of internal crystals. Nickel- and lithium-based batteries call for different charge algorithms. Li+ batteries need protection circuitry to monitor and protect against overcurrent, short circuits, over- and under-voltage, and excessive temperature. Remember to remove a battery from its charger when the battery is not used regularly, and apply a topping-charge before use.

---

Application Note 3501: <http://www.maxim-ic.com/an3501>

### More Information

For technical questions and support: <http://www.maxim-ic.com/support>

For samples: <http://www.maxim-ic.com/samples>

Other questions and comments: <http://www.maxim-ic.com/contact>

### Related Parts

DS2720: [QuickView](#) -- [Full \(PDF\) Data Sheet](#) -- [Free Samples](#)

Additional legal notices: <http://www.maxim-ic.com/legal>