

OIL PRESS

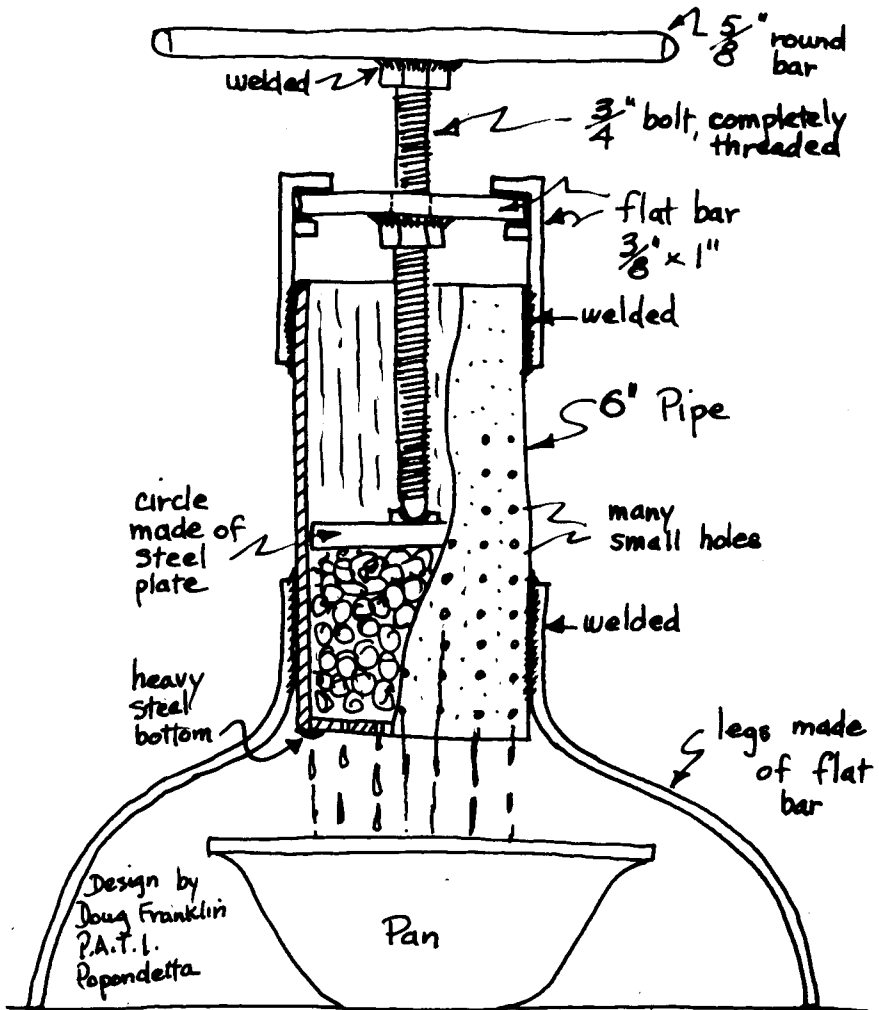

SIMPLE OIL PRESS
(cutaway view)

FUEL

for the
New Millennium:



One Low-Tech Solution to a High-Tech Problem

Joshua & Kaia
Tickell

©1999 Joshua & Kaia Tickell

Restaurant fryer filters are available at restaurant supply stores and are excellent for filtering food particles out of used cooking oil.

Making your own fuel from vegetable oil can be easy, cost-effective, and environmentally beneficial. What makes this fuel even more attractive is that you can make it from the waste vegetable oil produced in the United States every year, which amounts to more than three billion gallons. With a bit of know-how and persistence, you can run any diesel engine on vegetable oil.

Only diesel engines can run on vegetable oil-based fuels. This means that any engine that has spark plugs and is made for leaded or unleaded gasoline cannot use vegetable oil fuel. If you want a practical homemade fuel for a gasoline engine, you might consider making ethanol, methane, or wood gas.

Grow Your Fuel

We produce a large quantity of used vegetable oil in the United States, but there is an oilseed crop you can grow no matter where you live. The possibilities include coconut, soybean, canola (rapeseed), sunflower, safflower, corn, palm kernel, peanut, jatropha, and hundreds more. To learn which vegetable oil crop is best suited for your area, contact your state's office of agriculture, the agriculture department of a local university, or talk to local farmers.

One of the crops with the highest yield of oil per acre is canola. From just one acre of canola, you can produce 100 gallons (379 l) of vegetable oil. The most common oilseed crop in the U.S. is soybeans, which produce 50 gallons (189 l) of vegetable oil per acre.

Growing your own oilseed crop has an added bonus. The meal that is separated from the oil is an excellent source of protein. This meal can be used as animal feed or in breads, spreads, and other food products.

Pressing the oil from the seed does not require a large, expensive press. TabbyPressen of Sweden makes a

tabletop press for around US\$1,000. Although the press usually comes with a 240V/50 cycle electric motor, you can buy the press with a 120V/60 cycle motor from the U.S. distributor. The press looks like a powerful juicer. To operate it, pour the oilseed into the funnel and wait for the vegetable oil to pour out of the bottom. The meal oozes out of the side of the press.

The Three Ways to Use Vegetable Oil as a Fuel

Diesel engines that are found in cars, trucks, generators, boats, buses, trains, planes, pumping stations, tractors, and agricultural equipment can all run on fuel from vegetable oil. Pure vegetable oil, lard, and used cooking oil work just as well as diesel fuel.

Biodiesel

The most conventional method of running a diesel engine on vegetable oil fuel is to produce a fuel called biodiesel. Biodiesel is made by combining 10 to 20 percent alcohol with 0.35 to 0.75 percent lye and 80 to 90 percent vegetable oil. A very reliable reaction can be made with 80 parts new vegetable oil, 20 parts methanol, and 0.35 parts lye. These ingredients are mixed together for an hour and left to settle for eight hours.

After the chemical reaction is complete and the new products settle out, you have biodiesel fuel and glycerin soap. The fuel is yellow to amber in color and flows like water. The soap is brown in color and has the consistency of gelatin. The soap settles to the bottom, allowing you to pump, siphon, or pour off the biodiesel.

Veggie/Kero Mix

The second method for using vegetable oil in a diesel engine is to simply "cut" the oil with kerosene. This method is best suited for emergencies, heavy duty engines, and warm temperatures. Although it is possible to mix other petroleum products with vegetable oil, kerosene is most suited for the diesel engine.

Depending on ambient temperature, the blend of kerosene to vegetable oil will be anywhere from 10 percent kerosene and 90 percent vegetable oil to 40 percent kerosene and 60 percent vegetable oil. A fairly reliable blend is 20 percent kerosene to 80 percent vegetable oil.

The effectiveness and reliability of the veggie/kero method is increased by starting and cooling down the diesel engine on diesel fuel or biodiesel fuel. This can be accomplished by installing an extra fuel tank and switching to the veggie/kero mix when the engine is warmed up.

Straight Vegetable Oil

The third method for running a diesel engine on vegetable oil is to use straight vegetable oil. As with the



Our friend, Hugo Brown, pouring grease. A container of used cooking oil can be found behind most restaurants.

other methods, you can use either pure vegetable oil or used cooking oil. To ensure the reliability and longevity of your diesel engine, the engine must be started and cooled down on diesel or biodiesel fuel. This also requires the use of an extra fuel tank and a valve to switch between the tank of diesel or biodiesel fuel and the tank of vegetable oil. Think of it as a startup tank and a running tank.

The key to running a diesel on straight vegetable oil is to heat the vegetable oil at every stage—in the fuel tank, fuel hose, and fuel filter. The vegetable oil must be heated to at least 70°C (160°F).

Most diesel engines have hoses that carry hot coolant. This coolant can be channeled to heat the vegetable oil hoses, tank, and filter. You can make simple modifications to the coolant hoses. These modifications combined with some extra fuel and oil hoses, an extra fuel tank, and an electrically operated switch will allow you to run your diesel engine on straight vegetable oil.

Fuel Comparison

The chart will show you the differences between the three vegetable oil fuel methods. As you can see, biodiesel is a good substitute or additive fuel for diesel fuel. Veggie/kero mix is decent for use as an emergency fuel. And using straight vegetable oil is good if you have the time and know-how to properly modify

Comparison of Different Vegetable Oil Fuel Methods

Property	Biodiesel	Veggie/Kero Mix	Straight Veggie Oil
Can be used as lubrication additive to diesel fuel	yes	no	no
Requires vehicle modification	no	yes	yes
Reliably cuts emissions in all diesel engines	yes	no	unknown *
Considered an alternative fuel under the United States Energy Policy Act (EPACT)	yes	no	yes **
Simple way to run a vehicle in an emergency	no	yes	no
Stable fuel at room temperature	yes	no	no
Requires added chemicals to produce	yes	yes	no
Requires startup tank of biodiesel or diesel fuel	no	yes	yes
Good startup fuel	yes	no	no
Better lubrication than diesel fuel	yes	yes	yes
Gels in cold weather	yes	yes	yes
Covered by many engine warranties	yes	no	no
Can be made from used cooking oil	yes	yes	yes
Can be made from pure vegetable oil	yes	yes	yes
Safe to store and handle, biodegradable, won't spontaneously ignite, and non-toxic	yes	no	yes
Works in all diesel engines	yes	yes	yes
Can be reliably mixed in any proportion with diesel fuel without vehicle modification	yes	no	no
Approved for use by EPACT in a 20% mix with 80% diesel fuel ***	yes	no	no
Engine life, power, torque, fuel mileage, and overall performance are relatively unaffected	yes	yes	yes
Can clog fuel injectors if used improperly	no	yes	yes
Requires heating for operation at any temperature	no	no	yes
Tested and documented by U.S. universities	yes	no	yes
Possible substitute for home heating oil in furnaces	yes	no	no
Can be used in Petromax brand and similar lanterns and stoves	yes	no	yes

* No recent U.S. University studies have been published on this.

** Under EPACT regulations, any biologically-derived fuel is considered an alternative fuel.

*** EPACT legislation states that a fleet must use a minimum of 450 gallons (1703 l) of biodiesel per year.

your engine's heating and fuel tank systems. Diesel engines are used in many different situations. For each situation, there is a way to make fuel from vegetable oil.

How to Make Biodiesel

This section outlines the process for making biodiesel fuel from new vegetable oil or used cooking oil. This fuel can be made in a blender or in a larger, homebuilt mixer. The materials you'll need are vegetable oil, methanol, and lye.

If you are using new vegetable oil, always use 3.5 grams of lye per liter of oil. Since each batch of *used* cooking oil is different, the amount of lye in each batch of biodiesel will be different. To ensure that you are using the correct amount of lye, make a small test batch of biodiesel in a blender before attempting a reaction in a large mixing tank. For the test batch, use 100

milliliters of vegetable oil and 20 milliliters of methanol. Then you must determine how much lye to use.

If you are using used vegetable oil, use 0.45 grams of lye for the first test batch. If this batch makes biodiesel and glycerin, use the same proportions for the large batch reaction. If the test batch does not form two distinct layers, increase the amount of lye to 0.55 grams and make another test batch. If this batch is unsuccessful, make another batch and increase the amount of lye to 0.65 grams. If that batch is unsuccessful, make another batch with 0.75 grams of lye. Make sure you can make biodiesel on a small scale before attempting a large reaction.

Once you have made a successful small test batch of biodiesel, multiply the number of grams of lye you used by ten to see how much lye you will need for each liter of oil in the large reaction. For example, if you used 0.55 grams of lye in the test batch, you will need to use 5.5 grams of lye per liter of used cooking oil for a large reaction.

Here is the basic procedure for making biodiesel fuel. Read the safety information at the end of this article before you begin.

1. Purchase or collect new or used vegetable oil.
2. If the oil is used cooking oil, use a restaurant fryer filter to remove burned food bits, etc.
3. Purchase some methanol alcohol from a local racetrack or chemical supply store. Ethanol alcohol can also be used, but the process is different.
4. Purchase some granulated lye (Red Devil is one brand) or caustic soda sold as a drain cleaner from the hardware or grocery store. It must be pure sodium hydroxide (NaOH).
5. Measure the amount of vegetable oil you want to use in liters. We will call this number V. Pour the vegetable oil into the mixing container.
6. When the temperature is below 70°F (21°C), or when the vegetable oil is solid or lumpy, it will be

necessary to heat the reactants before, during, and possibly after the mixing. The ideal temperature to attain is 120°F (49°C). A fish tank heater will heat 10 to 30 gallons (40–120 l) of reactants. For larger batches of biodiesel, a water heater element can be mounted in a steel biodiesel mixing tank. Make sure that you follow the manufacturer's directions and safety precautions when adding any electrical device to the system. Be careful when heating vegetable oil in a plastic container. Polyethylene cannot withstand temperatures above 140°F (60°C).

7. Multiply $V \times 0.2$. The result will be the amount of methanol you will need in liters. We will call this number M.
8. To determine how much lye you will need to use for new vegetable oil, multiply V times 3.5 grams. For used vegetable oil, use the number of grams of lye you got in the small test batch. For example, if you used 0.55 grams of lye in the test batch, you will multiply V times 5.5 grams of lye. Call this number L.
9. Carefully pour L grams of lye into M liters of methanol. Stir until the lye is dissolved in the methanol. Be careful, this creates a toxic substance called sodium methoxide.
10. Pour the sodium methoxide into the vegetable oil right away. Stir vigorously for one hour.
11. Let the mixture settle for eight hours.
12. Pump the biodiesel from the top, or siphon it off with a hand siphon. Or if you are lucky enough to have a container with a spigot, open the spigot and drain the bottom layer of glycerin. The glycerin will be much thicker and darker than the top layer of biodiesel.
13. Allow the glycerin to sit in the sun for a week. After that, the trace methanol will be evaporated. You have made a nice glycerin soap. You can scent it with the fragrance of your choice, add other soap agents as desired, or just use it as it is. This soap is especially good for cleaning grease off your hands and cleaning greasy equipment!
14. Make sure your biodiesel goes through a 5 micron filter before entering your diesel engine.

A Simple Biodiesel Processor

The simplest way to make a biodiesel processor is to use a 55 gallon (208 l) steel drum and some sort of mixer. The mixer can be a circulating pump, such as a sump pump, or it can be an electric mixer for chemicals, specially made for drum stirring.

Making Biodiesel Flow Chart

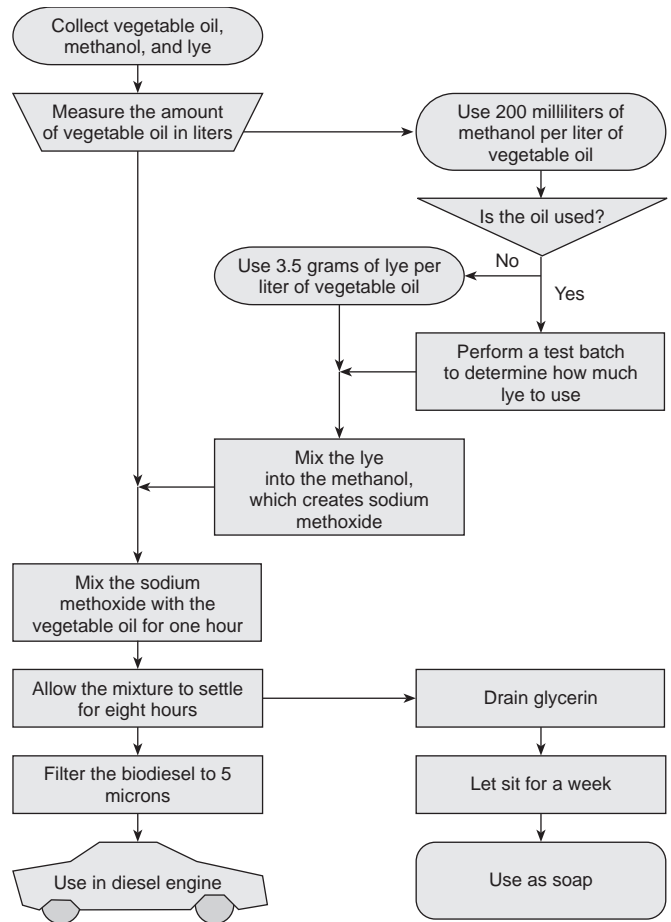

A pump or stirrer will cost about US\$200 if you buy it new, but you can build your own instead. With a bit of ingenuity, you can build a biodiesel processor that is inexpensive and effective. Tim Garrits of Kelseyville, California built such a processor from mostly recycled parts for under US\$50. A simple biodiesel processor can be built from the following parts:

- A 55 gallon (208 l) metal drum.
- A 1/2 hp electric motor.
- Two pulleys that give about 250 to 400 rpm at the mixer blade.
- A belt that goes around both pulleys.
- A rolled 2 inch (5 cm) rod for the mixer shaft.
- A propeller made from two shelf brackets, welded to either side of the rolled 2 inch rod. The shelf brackets look like two opposed "L"s and form a propeller about 14 inches (36 cm) in diameter. Basically any propeller-shaped metal would do, if it is made from about 12 or 14 gauge steel.

- A 3/4 inch (19 mm) brass ball valve for draining the glycerin.
- A hinge and piece of wood acting as a belt tensioner.
- A 2,000 watt electric water heater element.
- A water heater thermostat.
- Wood, screws, bolts, and other assorted mounting hardware.

A Note of Caution

You are dealing with dangerous chemicals when you make biodiesel. Both methanol and lye are strong bases. They can deaden nerve endings and cause permanent damage. For this reason, chemical resistant gloves, aprons, and eye wear should be worn when dealing with methanol and lye. Shoes, long sleeve shirts, and long pants are a must.

Keep both methanol and lye in clearly marked containers. We recommend putting a skull and crossbones on them and writing something to the tune of "Danger! Toxic! Do Not Eat!" in addition to the contents.

Sodium methoxide, the chemical combination of lye and methanol, is even more toxic than the separate components. Keep this stuff away from any exposed skin. Do not let children play in or around biodiesel equipment. Remember, although you are creating two chemically benign substances when you make biodiesel, you are using dangerous chemicals in the process.

Always keep safety in mind when preparing a biodiesel reaction. Have a faucet or hose nearby. Keep some vinegar handy to neutralize any methanol or lye that may spill. If you take the time to prepare and follow safety guidelines, your biodiesel reaction will go smoothly and you should have no problems.

Fuel Tax & Engine Specifications

If you live in the U.S., you are responsible for paying the IRS for any on-road fuel that is not taxed at the pump. If you live outside the U.S., it would be wise to check with local authorities as to taxation.

You are responsible for any damage that may result to your engine if you use a fuel that does not meet your engine manufacturer's specifications.

Go For It!

Disclaimers aside, biodiesel is used all over the world. Island people are making biodiesel from coconut oil, some countries are experimenting with biodiesel from hemp seed oil, and many others are using canola oil. Millions of miles of road tests have been done with this

fuel. Tests have shown less wear on the internal components of engines using biodiesel.

Biodiesel is a reliable, exciting fuel that you can make. If you are worried about your diesel engine, you can install an extra fuel filter system from Racor or a similar aftermarket parts manufacturer. After traveling over 25,000 miles (40,000 km) on biodiesel made from used cooking oil, we continue to choose and recommend biodiesel over toxic, carcinogenic petroleum diesel fuel.

Complete instructions, diagrams, photos, and parts lists for the three methods of running a diesel engine on vegetable oil and building a biodiesel processor are included in the new, second edition of *From the Fryer to the Fuel Tank*.

Access

Author: Joshua & Kaia Tickell, GreenTeach, PMB 311, 15 Paradise Plaza, Sarasota, FL 34239 USA
biodiesel@best.com • www.veggievan.org

New Second Edition! *From the Fryer to the Fuel Tank: The Complete Guide to Using Vegetable Oil as an Alternative Fuel* by Joshua and Kaia Tickell, US\$29.95 postpaid (outside USA add US\$5) from BookMasters, PO Box 388, Ashland, OH 44805 • 800-266-5564 or 419-281-1802 • Fax: 419-281-6883
order@bookmaster.com • www.bookmasters.com

The Green Wire, a free email newsletter covering homemade fuel and more:
www.veggievan.org/greenwire

Diesel fuel filtration and heating equipment manufacturer: Racor Division, PO Box 3208, Modesto, CA 95354 • 800-344-3286 or 209-521-7860
Fax: 209-529-3278 • kedge@parker.com
www.parker.com/racor

Plastic products, electric drum mixers, & sump pumps: United States Plastics Corp., 1390 Neubrecht Rd., Lima, OH 45801 • 800-537-9724 or 419-228-2242
Fax: 800-854-5498 or 419-228-5034
usp@usplastic.com • www.usplastic.com

TabbyPressen Type 20, U.S. dealer: Magic Mill, 382 Route 59, Sec. #338, Monsey, NY 10952
914-368-2532 • Fax: 914-368-2533
magicmil@mail.idt.net • www.oilpress.com

Tim Gerrits, Tim Gerrits Designs, PO Box 493, Kelseyville, CA 95451 • hpbioid@kelseyville.com
www.kelseyville.com/biodsl



BUILDING A SINGLE TANK BIODIESEL PROCESSOR

The simplest way to make a small biodiesel processor is to use a steel 55 gallon drum and a chemical mixer. A single tank biodiesel processor uses the same container for mixing and settling. No extra containers, pumps, piping, or mixers are needed. The single tank processor can be made from common salvaged and recycled parts. This processor can cost as little as \$50 and as much as \$500 to build, depending on how many new parts are bought. The parts listed here are based on standard measurements. We include the metric conversion for each of the sizes.

Parts List

The following parts can be used to build a single tank biodiesel processor using a steel 55 gallon drum:

1. A steel 55 gallon (210 liter) drum.
2. A $\frac{1}{2}$ or $\frac{3}{4}$ horse power electric motor.
3. Two pulleys which will produce a minimum of 250 revolutions per minute (rpm) and a maximum of 750 rpm at the mixer blade.
4. A belt to wrap around both pulleys.
5. A $\frac{1}{2}$ inch (12.7 mm) rolled steel rod.
6. A propellor made from two 3 inch (8 cm) long 12 or 14 gauge steel shelf brackets, welded to either side of the $\frac{1}{2}$ inch rolled steel rod. The shelf brackets look like two opposed "L"s and form a propeller which is about 6 inches (15 cm) in diameter.
7. A $1\frac{1}{2}$ inch (38 mm) brass ball valve.
8. A hinge and a spring which act as a belt tensioner.
9. A 2000 watt electric water heater element.
10. A water heater thermostat.
11. A $1\frac{1}{2}$ inch diameter piece of steel pipe 3-5 inches (8-13 cm) in length, with male pipe threads on one end.
12. Angle iron, wood, screws, bolts, and other assorted hardware.
13. A long, flat piece of 1-2 inch (3-5 cm) wide steel or aluminum.

Assembly: Mixing Tank

1. Cut a large opening in the top of the steel drum. If the mixing tank is going to have a conical bottom, skip steps 2-4.
2. Drill a $1\frac{1}{2}$ inch hole in the bottom of the side of the drum.
3. Weld a $1\frac{1}{2}$ inch diameter piece of steel pipe in the hole in the bottom of the side of the drum.
4. Attach a $1\frac{1}{2}$ inch brass ball valve to the piece of pipe. This will serve as the drain valve.
5. Drill a hole on the bottom of the drum the same size as the electric water heater element you will be using.
6. Install the water heater element, making sure that the element is not touching the inside of the drum.
7. Wire a thermostat to the water heater element.

Assembly: Chemical Mixer

A mixer which spins below 500 rpm can use a large, heavy propeller. A mixer which spins above 500 rpm will need a small, lightweight propeller. To make your own mixer, you will need an electric motor, a straight rolled steel rod at least $\frac{1}{2}$ inch in diameter, two pulleys, a belt, a hinge, and something to use as a propeller.

1. Attach one pulley to the rolled steel rod and attach the other pulley to the spindle of the electric motor.
2. Weld the propeller to the other end of the steel rod.
3. Attach the rod, pulley, and propeller assembly to one side of the hinge.
4. Weld a piece of angle iron across the top of the drum.
5. Weld the unattached side of the hinge to the angle iron so that the propeller and rod assembly goes into the middle of the drum. The hinge should swing the propeller and rod back and forth.
6. Mount the electric motor on the side of the drum.
7. Put a belt between the pulleys. Tighten the pulleys by wedging a block of wood into the hinge.

Assembly: Conical Bottom (Optional)

A conical bottom is a simple addition to any single tank biodiesel processor. A welding shop can make this.

1. Cut the bottom off of the steel drum with a torch.
2. Make a cone shape with sheet metal, leaving a $1\frac{1}{2}$ inch opening.
3. Weld the cone to the bottom of the drum.
4. Attach a $1\frac{1}{2}$ inch diameter piece of steel pipe to the end of the cone.
5. Attach a $1\frac{1}{2}$ inch brass ball valve to the steel pipe. This is the drain valve.
6. Using angle iron, make a 3 or 4 leg stand for the drum. Make sure there is enough room under the bottom of the cone to put a large bucket or fuel container.

Assembly: Measuring Stick

A long piece of 1-2 inch wide aluminum or steel will allow you to measure the amount of reactants in the mixing chamber. By marking the metal stick with graduations, you will create a measuring stick.

1. Add 10 liters of water to the mixing tank.
2. Put the long piece of aluminum or steel into the mixing tank and mark the level of the water on the stick.
3. Pull the measuring stick out of the water and scratch a line across it where the water level was. Scratch the number 10L into the metal on top of or beside the line.
4. Add another 10 liters of water and repeat the process this time marking the metal with 20L.
5. Put another 10 liters in and mark 30L, then 40L, and so on.
6. Repeat the process until the mixing tank is full of water and the measuring stick is full of measurements. Drain the water.

MAKING BIODIESEL IN THE SINGLE TANK PROCESSOR

The only difference in the procedure for making biodiesel in a blender and the procedure for making biodiesel in this processor is that the alcohol/catalyst solution must be mixed with the vegetable oil for 1 hour. To make biodiesel in the single tank processor, refer to the biodiesel procedure in Chapter 6 and follow these steps:

1. Do a titration to determine the amount of free fatty acids in the used cooking oil. If you are using new vegetable oil, skip the titration.
2. Make a mini batch of biodiesel in a blender using 100 milliliters or 500 milliliters of vegetable oil. Did two distinct layers settle out of the mini batch?
 - a. If yes, go to step 3.
 - b. If no, make another mini batch using a different amount of catalyst.
 - c. Do not make a large batch of biodiesel until you can successfully make a mini batch.
3. Measure the amount of vegetable oil, alcohol, and catalyst for the large batch of biodiesel.
4. Dissolve the catalyst in the alcohol by mixing them together for up to 5 minutes.
5. Add the vegetable oil to the alcohol/catalyst solution and mix vigorously for 1 hour.
6. Allow to settle for at least 8 hours.
7. Drain the glycerin.
8. Filter the biodiesel.

Top view of the single tank biodiesel processor based on a steel drum.

Facing Page: Side view of single tank biodiesel processor. The dotted lines show the optional conical bottom. Neither diagram is drawn to scale.

Single Tank Biodiesel Processor (Top View)

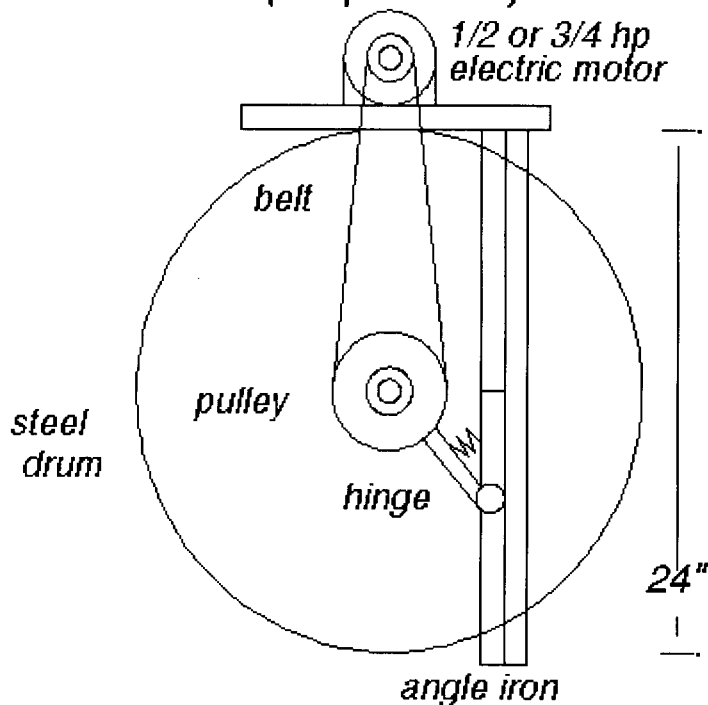

Single Tank Biodiesel Processor

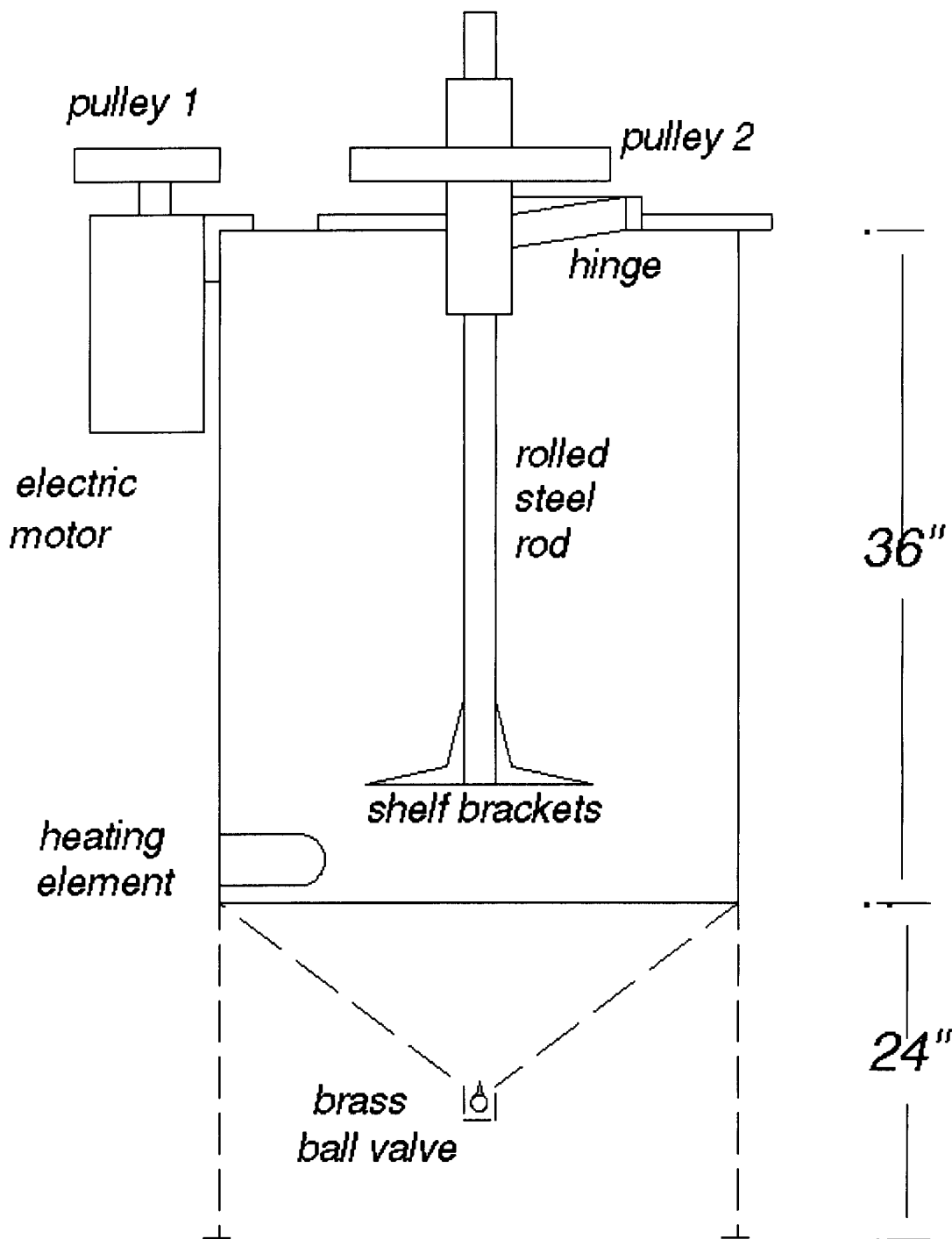

Q&A

Irresistible Biodiesel

Joshua and Kaia Tickell's article *Fuel for the New Millennium, One Low-Tech Solution to a High-Tech Problem* (HP72, page 84) was very interesting. I could not resist trying it out, as my country, Malaysia, produces lots of palm oil. Before proceeding, I consulted a chemist friend who told me that potassium hydroxide can be used as an alternative to sodium hydroxide (lye). Potassium hydroxide produces a softer soap!

The fuel turned out as described in the article after calibrating the containers for mixing the raw materials and carrying out a batch to test efficacy of the methoxide. Altogether I made approximately 12 litres of the biodiesel. My contractor was a bit skeptical about the biodiesel, but I managed to collar a couple of victims to try it out. The response was encouraging. They could feel their engines running more quietly and with less vibration because the biodiesel provides better lubrication than mineral diesel.

I did a further experiment. I doped gasoline with approximately 2 ml of biodiesel per litre of gasoline for use in a carbureted engine (1.5 ml per litre for fuel injection engines). The engine in the passenger car I am using did not suffer disastrous consequences. It performed beyond my expectations. The biodiesel is being used like a two-stroke lubricant for upper cylinder lubrication, and also as a fuel. The engine runs quieter and with less friction (all subjective).

When I manufactured the biodiesel, I controlled the pH (acidity) of the biodiesel to approximately pH 12 as my chemist friend suggested, with the help of pH strips. After discussions with him, I realised that the biodiesel is a really good fuel because the internal combustion engines we are using spew out tonnes of acid (sulphuric). This can be neutralised by biodiesel which has been set at the correct alkalinity. Any ideas on how much this pH should be and the dosage for gasoline and diesel fuel to neutralise the acid? Thanks to your good work, and I'm looking forward to many more articles. YC Lim • limyenchung@yahoo.com

Mr. Lim, It's great to hear about your success with making biodiesel in Malaysia. I'm glad you pointed out that potassium hydroxide (KOH) can be used instead of sodium hydroxide (NaOH). As I mention in From the Fryer to the Fuel Tank, KOH is more readily available in some parts of the world, and you're right, it does produce a milder soap. In fact, if you need to add

potassium to your soil (this is the purpose of many fertilizers), the leftover glycerin soap from a KOH biodiesel reaction is a perfect fertilizer.

While I haven't done any serious experiments to this end, I have read a few recent papers on the use of biodiesel as a gasoline fuel additive. Although a gasoline engine will not run on biodiesel, very small amounts of biodiesel can apparently be added to gasoline to increase its lubricating and cleaning properties. I'd love to hear from more folks who have tried this.

I don't know all of the ins and outs of emissions chemistry, but I must mention here that biodiesel contains no sulfur and therefore emits no sulfur dioxide (SO₂). Fuels that do contain sulfur, like gasoline and diesel fuel, emit SO₂ as a result of the sulfur in the fuel attaching to the oxygen in our atmosphere. The only way to effectively neutralize sulfur dioxide emissions is to remove the sulfur from petroleum fuel or use a fuel which contains no sulfur, like biodiesel. Again, good work, and I look forward to hearing more about your biodiesel program as it develops. Joshua Tickell biofuel@best.com

DIY Wind

Home Power, I would like to know how to rewind an ordinary 3-phase motor into a permanent magnet, direct drive, slow-speed alternator for wind applications. I would also like to know how to rewind automotive alternators for direct drive, slow-speed wind applications in such a way as to eliminate the need for gear up and the field terminal.

What is the best aircraft alternator to use for wind applications? Do they need to be rewound for this also? If so, how do I make a direct drive, slow-speed unit to eliminate the need for gearing up and the field terminal? I will be anxiously awaiting your reply. Sincerely, David Hodgson

David, people have been awarded master's degrees for answering the questions you've asked. While I can't answer your question with an exact number of turns in a given coil of wire, I can send you in some good directions.

Way back in HP17, I did an article titled So You Want to Build a Wind Generator? That article reviewed a number of plans, articles, and books about designing your own alternator or generator, or rewinding an existing one for different voltage, current, and rpm specifications. Many of the sources cited will take a bit of serious research to unearth, but they're still out there. Print copies of HP17 are still available from Home Power, and the issue is also on the Solar2 CD-ROM. Contact HP about availability and prices.

Alive with Biodiesel

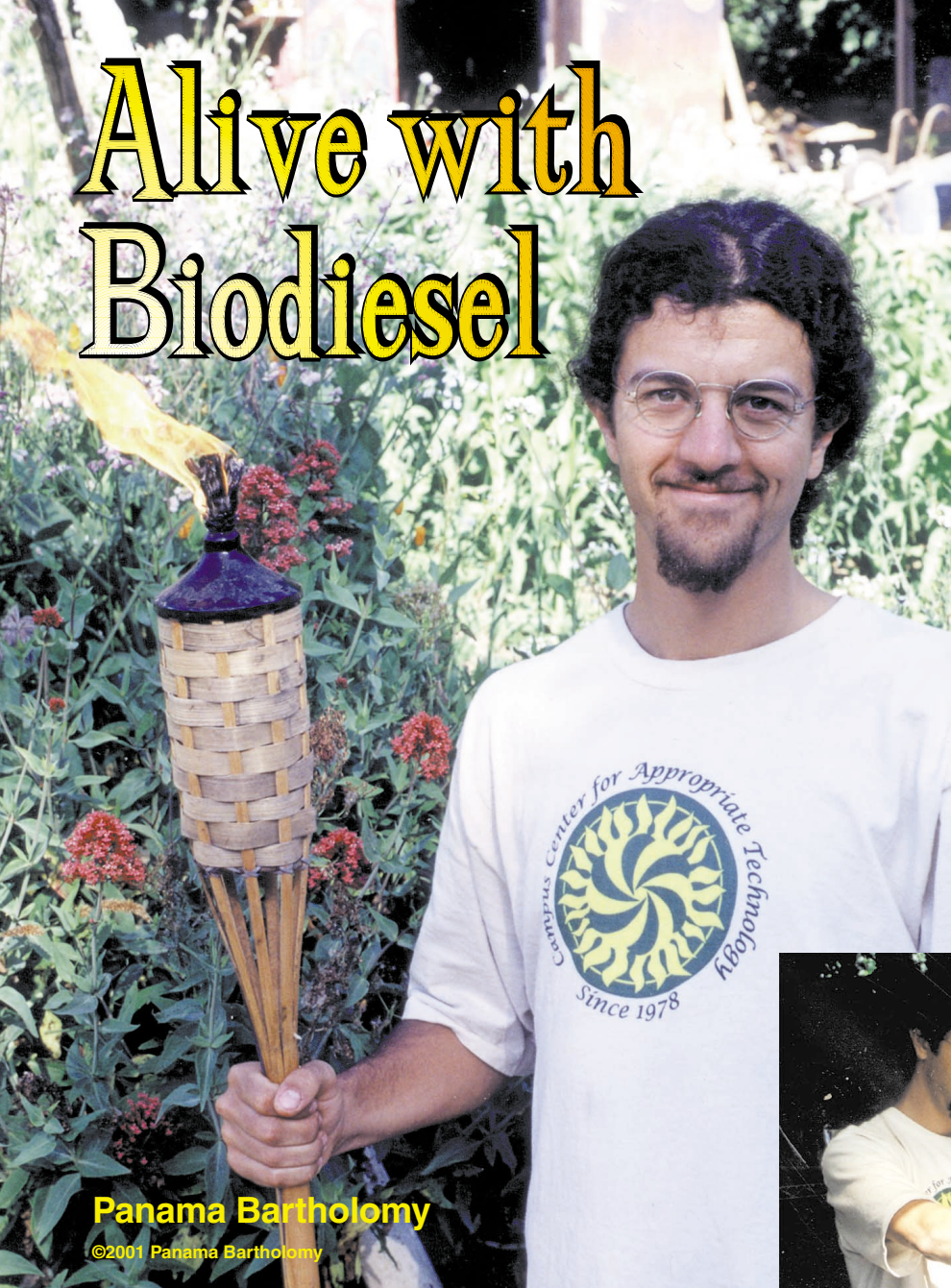

Panama Bartholomy

©2001 Panama Bartholomy

I was intrigued, and went over to see what this was all about. A young couple was near the van, explaining how they had traveled cross-country from Florida to get here and that they did it all on this fuel called "biodiesel." They didn't have to modify their vehicle, and any unmodified diesel engine could run on the stuff. They told the crowd that there is a 75 percent reduction in greenhouse gases from the tailpipe with biodiesel, and that the exhaust smells like french fries. The couple was Joshua and Kaia Tickell, and they were about to become my inspiration.

Left: Author Panama Bartholomy shows off biodiesel at Humbolt State University's Campus Center for Appropriate Technology.

Below: Finished biodiesel is pumped into a fuel can.

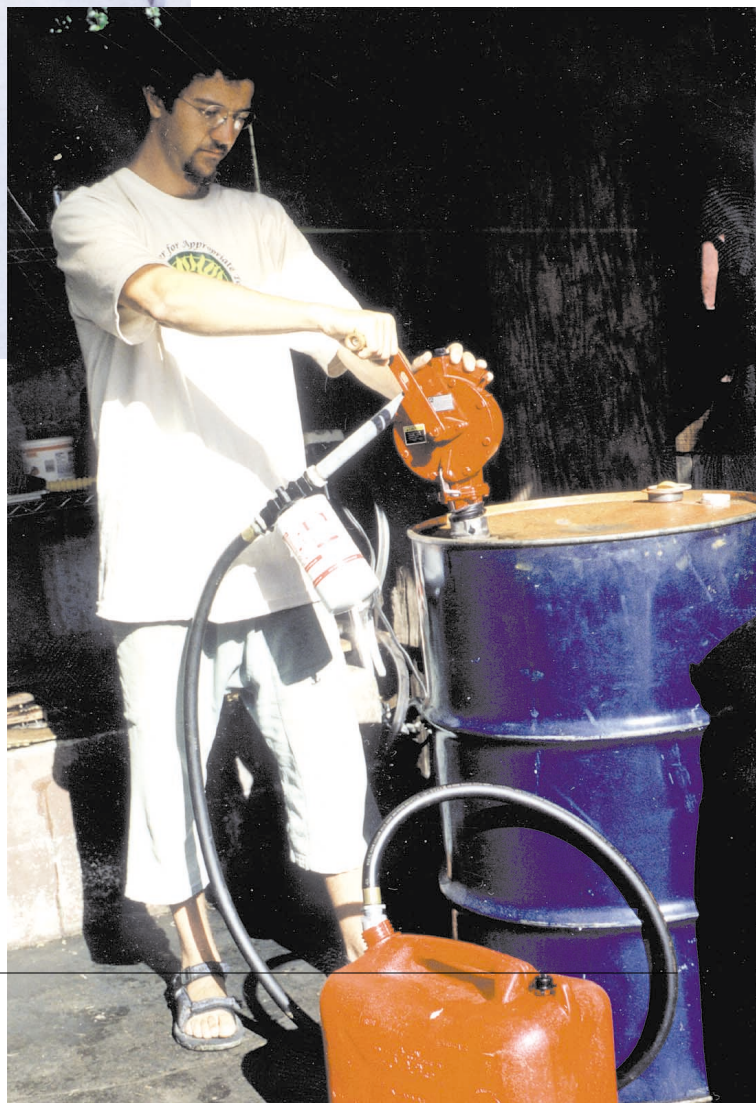

"Don't ask yourself what the world needs. Ask yourself what makes you come alive, and then go and do that. Because what the world needs is people who have come alive."

—Harold Thurman Whitman

The first time I heard of biodiesel, I was at the Health and Harmony Festival in northern California in the summer of 1998. On display was a van with sunflowers painted all over it and lettering explaining how many miles per acre the van got on a vegetable oil based fuel.

The Fuel for My Fire

I bought their book, *From the Fryer to the Fuel Tank*, and that fall, Andy Cooper, Anna Lee, and I built a mini-refinery (a blender) for our Appropriate Technology class at Humboldt State University. The folks up at the Campus Center for Appropriate Technology (CCAT)—on campus but off the grid since 1991—approached us about replacing their dying natural gas generator with a diesel generator fueled by our biofuel.

As another added benefit, Andy and I both have diesel vehicles, and we wanted to free ourselves from the greedy grasp of the Western Fuel Association. After a couple of months of researching, pricing, and planning, we made the ungainly leap from our blender to the home-scale refinery described below.

The System

The thing that surprises most people about biodiesel is how easy it is to make. You don't need a chemistry degree or access to a lab, and the setup can be cheap or expensive, small or large.

We wanted a setup that would allow us to produce, settle, and store multiple batches at the same time. To do this, we got three 30 gallon (115 l) barrels. One was the reactor, and two would be our settling tanks. Starting with 25 gallons (95 l) of reactants, we would be able to produce 20 gallon (75 l) batches three times a day.

We begin with oil recovered from local restaurants and the university cafeteria, the "J" (Our slogan: Now there's more than one way to get gas from the "J"!). We look for clean, thin oil with not many food particles, and we filter out any extra french fries through a small screen mesh filter.

Some restaurants are good about changing their fryer oil, while some are not. That makes a big difference in the acidity of the oil, which is determined with a simple pH kit. The acidity determines the amount of lye we have to add. We have looked into over eighty "waste" oil containers in the last year. My options for eating out in our area are very limited now due to the knowledge I've gleaned from these excursions.

We pour the filtered oil into a 30 gallon barrel, and light the propane burner underneath it. The oil has to be heated to about 125°F (52°C) for the "transesterification" reaction to take place, turning vegetable oil into biodiesel. Transesterification is the process of using an alcohol (such as methanol or ethanol) in the presence of a catalyst (such as sodium hydroxide or potassium hydroxide) to chemically break the molecule of the raw renewable oil into methyl or ethyl esters, with glycerol as a byproduct.



Panama uses a paint mixer to combine methanol and lye in a closed container to make sodium methoxide. In this posed photo, he skipped the usual protective gear.

As it is heating, we calculate how much lye to add (1–3% of the total mixture) based upon the pH test. We measure out the amount of methanol required to make the proportions of the mixture 80 percent oil and 20 percent methanol.

We get our methanol from a local petroleum distributor, and our lye from a janitorial supply dealer. We mix the methanol and lye together very carefully, since the combination, sodium methoxide, is very dangerous. Any time we deal with lye, we wear gloves, long-sleeved shirts, and safety glasses. Sodium methoxide will eat your nerves, so it may be too late to save your skin by the time you realize something is wrong. But after two years, all three of us still have all of our skin.

We isolate the sodium methoxide by making it in a closed container and using a paint mixer that attaches to an electric drill. After five minutes of mixing, we add the sodium methoxide to the oil.



In the reactor tank, ingredients are mixed with an electric outboard motor and heated with a propane burner.

In the reactor tank we now have oil and sodium methoxide. We turn on the small electric outboard motor (powered by a battery), and start mixing the batch. The outboard was by far the cheapest tool we found to mix 30 gallons (115 l) of thick oil. But with a little mechanical skill, you could easily make a mixer. We power our mixer with a deep-cycle battery that we will be recharging with our new diesel generator. For now, we are recharging it with one of our biodiesel vehicles.

After the first fifteen minutes, you can tell whether or not a reaction is taking place by observing the color change in the mixture. After about an hour and a half of mixing, the batch is ready to settle out.

We welded a bung into the side of the barrel so we can use gravity to get the mixture into 5 gallon (19 l) containers. Next we pour it into the settling tanks. Once in a settling tank, the mixture settles out over eight hours into 20 percent glycerin on the bottom and 80 percent biodiesel floating on the top. While it's settling, we start on the next batch, or, since we often make a batch in the evening, go to bed.

We had valves welded into the bottoms of the settling barrels (thanks to the local muffler shop!), and the barrels are lifted off the ground so that we can drain off the batches using only gravity. When the batch is done settling, we drain off the glycerin, which has separated out to the bottom of the barrel. The glycerin that comes out is dark and thick. So we can tell when it is all out and we are starting to drain biodiesel—both the viscosity and color of the flow change.

We close the valve and test the specific gravity of the biodiesel with a hydrometer. If the hydrometer reads below 0.90 and above 0.84, we know that we have successfully made a batch of biodiesel! We've only had a couple of failed batches out of the dozens we've made, and they were in the early weeks when we were still working out the bugs in our system.

At this point, some people wash their biodiesel with water to extract any residual glycerin, along with excess methanol, alkali soaps, waxes, and acids. But this greatly increases the time of the operation (three to four more days) and uses a lot of water, so we skip that part, counting on the filter on our storage tank to take out all of the leftover glycerin.

We like to keep our settling tanks freed for the next batch, so we pour the biodiesel into the 55 gallon

CCAT Biodiesel Production Facility Costs

Item	US\$
Three 30 gallon barrels	\$150
Minn Kota Powermax 36 outboard motor	100
Tuthill 112 pump, 80 gpm	100
Metal-Fusion propane burner	87
Three ball valves for barrels	48
Armor Plate DC27-15 battery for motor	47
Shelving (used)	25
Paint mixer (used)	15
Olive barrel for sodium methoxide (used)	10
Cim-Tek 200E filter, 10 micron	9
Mesh screen for food particulates	6
Storage container, 55 gallon (donated)	0
Drill (donated)	0
Flame box for methanol storage (already had)	0
Hydrometer (donated)	0
Propane tank, 5 gallon (already had)	0
Setup labor (volunteer)	0
Thermometer (donated)	0
Triple beam balance scale (donated)	0
Welding (six-pack of beer per valve)	0
Total	\$668

(210 l) storage tank. As we need it, we pump the biodiesel out through a large, 10 micron fuel filter to catch any food bits, glycerin, or other impurities. It is now ready to power an engine!

Biodiesel is also very good for other uses. We have used it as a paint solvent, a bicycle chain lubricant, and a heavy-duty cleaner. It's also great as a starter fluid for fires. In Japan, they use biodiesel's solvent properties to clean out car engines. They drain out the motor oil and put biodiesel in its place. Then they run the engine and the biodiesel cleans the inside of the engine. When they drain the biodiesel, a lot of old, gunky motor oil residues come out, and the inside is spic and span. They put motor oil back in, and off they go.

The Products

"What about the 20 percent glycerin?" you ask. Some people make the glycerin into soap or any of the thousands of products with glycerin in them. We would like to do this eventually, but for now we are composting it. It is non-toxic and completely biodegradable.

After mixing, the biodiesel and glycerin mix is transferred via 5 gallon jugs to a settling tank.



The glycerin, which is darker, settles to the bottom.

The biodiesel fuels an '81 Volkswagen Rabbit pickup and an '80 Mercedes stationwagon. CCAT just bought a Hardy 2.4 KW AC diesel generator specifically to use the biodiesel and to replace their gerry-rigged DC natural gas Honda generator. It will work strictly as a battery charger. Our Trace 4024 power center is about 70 percent efficient, so we shouldn't lose that much of the energy to the battery charger. Biodiesel is also non-toxic, biodegradable (composts in 28 days!), and safe to store due to its high flash point (325°F; 163°C).

When all is said and done, the cost of a gallon of our biodiesel, using recovered oil and not including labor and setup costs, is around US\$0.70 a gallon (depending on your local lye and methanol costs). A "free" (not including pickup costs) gallon of oil + 1/5 gallon methanol at US\$3 per gallon + 24 grams lye at 2.5 grams for US\$0.01 = US\$0.70 per gallon (US\$0.19 per liter)!

History

When Rudolph Diesel created his diesel engine, it was able to run on pure vegetable oil. He got the idea from the fire starters of some tribes in Africa. While traveling in northern Africa around the turn of the century, Diesel witnessed tribes starting fires with tubes and a plunger device. The tubes would be sealed on one end and a bit of wood would be dropped in. Then the plunger would be pushed into the tube, forcing air to compress and heat the piece of wood. That piece would then be removed and used to start fires. Rudolf adapted the idea of the tube and created his engine, with veggie oil replacing the piece of wood.

He wanted to make an engine that a farmer could use without ever leaving his or her farm for fuel. But the car companies who have co-opted his creation designed fuel injection systems so that only a very thin, highly flammable waste product of the petroleum industry could be used—our modern day diesel fuel.

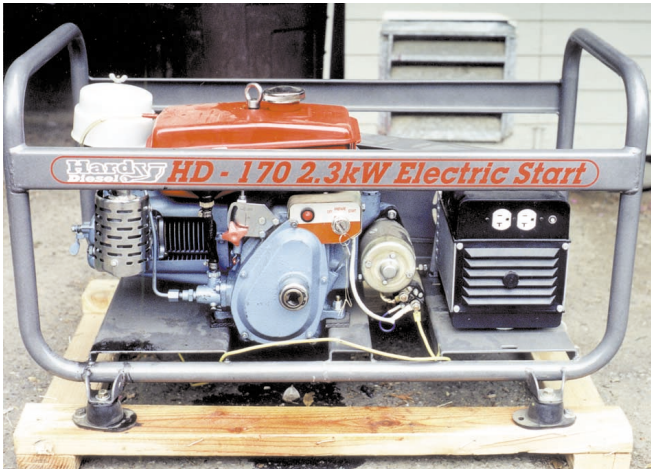

Now even CCAT's backup generator will be powered by renewable energy too.

How Does It Work in the Car?

What our whole process is really doing is slimming down the vegetable oil by removing its free fatty acids and making it more flammable by adding the methanol. The engines love it. They get the same mileage, and the same power and torque.

Standard diesels can be hard to start on cold mornings when the fuel will cloud or gel a bit. The same goes for biodiesel, and a winterizing agent will help with that. The exhaust smell is greatly improved—I can even talk people into putting their faces right up to the tailpipe.

Lessons Learned

First, both vehicles had problems initially when the biodiesel, an amazing solvent, knocked loose all the gunk (rust, algae, etc.) in the bottom of our twenty year old fuel tanks and sent it up to our fuel filters. That's apparently a common problem when biodiesel is first put in old tanks, and for us it simply meant replacing the filters.

Not only will biodiesel dissolve gunk in your tank, it will dissolve lastomir tank sealant. If you have already put that in your tank, expect to spend an afternoon cleaning sticky goo from the screen inside your tank. A similar warning goes for rubber fuel lines, which should be replaced with silicon lines after 10,000 miles (16,000 km) of biodiesel use.

Second, we bought some unnecessary things when we were first planning our system, but have since discovered that making biodiesel really isn't that complicated. We began with a setup where we filtered the oil while putting it into the mixing tank, requiring expensive metal shelving to support a barrel above the mixing barrel. But we discovered that we also wanted to filter it later to get out extra glycerin. Just filtering it at the end saved a lot of time, space, and mess.

Something that we already had that was very useful was a flame box—a flame resistant container, preferably metal, that can be locked and is safe to store flammables in. This is necessary, since we are located in a very public area. Since CCAT's function is educational, there are lots of people around. So for safety's sake, we keep the methanol, lye, and other stuff we don't want little ones to play with, in the flame box.

Third and last, we have learned the profound satisfaction of taking responsibility for making our own fuel for CCAT's generator and our own vehicles. We're also proud to be reusing a "waste" material, as well as making no net increase of carbon dioxide to the atmosphere. You can hold your head a little higher and feel a little more alive when you're driving with last year's soybeans, and your exhaust smells like donuts.

Access

Panama Bartholomy, Humboldt State University, Restorative Development Senior, CCAT volunteer, Center for Environmental Economic Development Campus Coordinator, 151 Hill St., Arcata, CA 95521 707-826-0298 • panamaredhat@hotmail.com

The National Biodiesel Board, 3337A Emerald Ln., PO Box 104898, Jefferson City, MO 65110 • 800-841-5849 or 573-635-3893 • Fax: 573-635-7913 biodiesel@sockets.net • www.biodiesel.org • Education and lobbying

From the Fryer to the Fuel-Tank, 3rd Edition, Joshua Tickell, ISBN 0-9707227-0-2, 176 pages. US\$24.95 from BookMasters, Inc., PO Box 388, Ashland, OH 44805 • 888-822-6657 or 419-281-1802 Fax: 419-281-6883 • tickell@veggievan.org www.veggievan.org

Pacific Biodiesel, 285 Hukilike St., B103, Kahului, HI 96732 • 808-877-3144 • Fax: 808-871-5631 info@biodiesel.com • www.biodiesel.com • Produces biodiesel fuel for diesel vehicles on Maui and does outreach to developing countries. They can build you a 200,000 gallon per year refinery.

The July/August 2000 issue of *Utne Reader* has a great article about rural farming with biodiesel in India.



**CHEAPESTSOLAR
.COM**

